



01

BATHROOM ACCESSORIES, COMPLEMENTS AND FURNITURE  
ACCESORIOS, COMPLEMENTOS Y MOBILIARIO DE BAÑO

# COSMIC

2024

CATALOGUE  
CATÁLOGO





# COSMIC

Stimulation, relaxation, comfort...  
the bathroom reintroduces us to  
ourselves through objects that  
transcend the merely functional.

---

Activarse, relajarse, sentirse cómodo...  
en el baño nos reencontramos con  
nosotros mismos, a través de una  
serie de objetos que trascienden lo  
meramente funcional.



# Bath Experiences

-  006 COSMIC
- 013 INDEX OF FIXINGS  
ÍNDICE DE FIJACIONES
- 014 INDEX OF FINISHES  
ÍNDICE DE ACABADOS
-  FREE STANDING ACCESSORIES  
COMPLEMENTOS
  - 016 **L'Avenir**
  -  024 **Lido**
  -  026 **Saona**
  - 028 **Saku**
  -  034 **Flat**
-  ACCESSORIES  
ACCESORIOS
  - 036 **Architect**
  - 050 **Architect S**
  - 074 **Bath Life**
  - 080 **Black & White**
  - 092 **Diabolo**
  - 098 **Duo**
  - 110 **Eda**
  - 116 **Extreme**
  -  124 **Geyser**
  - 138 **Kubic**
  -  152 **Line**
  - 160 **Logic**
  - 172 **Metric**
  - 182 **Micra**
  - 192 **Next**
  - 198 **Start**
  - 208 **Stick**
  - 218 **The Grid**
-  MAIN CATEGORIES  
CATEGORÍAS PRINCIPALES
  -  226 **Home fragrances**
  -  228 **Bathroom set**  
**Set de baño**
  - 240 **Magnifying mirrors**  
**Espejos de aumento**
  -  242 **Toilet brushes**  
**Escobilleros de baño**
  - 247 **Hooks & hangers**  
**Perchas y colgadores**
  - 252 **Toilet roll holders**  
**Portarrollos**
  - 258 **Shower baskets**  
**Jaboneras de ducha**
-  262 **Bins**  
**Papeleras**
- 264 **Furniture accessories**  
**Accesorios para el mueble**
-  265 **Portables**  
**Portátiles**
- 267 **Stools**  
**Taburetes**
- 268 **Contract**
-  FURNITURE WITH WASHBASIN  
MOBILIARIO CON LAVABO
  - 272 **Lagoon**
  - 310 **Wish**
  - 338 **Mod**
  -  346 **B-Best**
-  WASHBASINS  
LAVABOS
  - 370 **Compact**
  - 378 **Equilibrium**
  -  382 **Fancy**
-  BATHTUBS  
BAÑERAS
  - 392 **Mood**
-  LIGHTING  
ILUMINACIÓN
  - 396 **Light**
-  MIRRORS  
ESPEJOS
  - 402 **Lagoon**
  - 404 **Wish**
  - 406 **Basic**
-  CUSTOM FURNITURE  
MOBILIARIO A MEDIDA
  - 410 **Mobius**
- 438 INDEX OF REFERENCES  
ÍNDICE DE REFERENCIAS
- 450 SPARE PARTS  
RECAMBIOS
- 452 MATERIALS  
MATERIALES
- 456 SALES CONDITIONS  
CONDICIONES DE VENTA





# Cosmic

We create design environments for bathrooms. We transform spaces into pleasant places with aesthetic functionality. A nonconformist and visionary personality that leads us to the constant search for innovation focused on the customer: To enhance and offer an expressive and quality product in order to exhort to renovate, complete and decorate the bathroom.

---

Creamos ambientes de diseño para el baño. Transformamos espacios en lugares armoniosos con funcionalidad estética. Una personalidad inconformista y soñadora que nos posiciona en la innovación constante enfocada al cliente: Destacar, ofrecer un producto con expresión y valor que invite a renovar, completar y decorar el cuarto de baño.



# Cosmic around the world

## Cosmic en el mundo



## COSMIC



2 production centers.  
2 centros de producción.

**1985**

Created in 1985 as a manufacturer of bathroom accessories.

Creada en 1985 como fabricante de accesorios de baño.

**2008**

In 2008, strategic alliance with Roca to combine synergies and become global business leaders of furniture, bathroom accessories and shower enclosures.

En 2008, alianza estratégica con Roca para aunar sinergias y convertirse en líderes mundiales de negocio de mobiliario, accesorios de baño y mamparas de ducha.

**2009**

In 2009, Pomd'or (Blanch Cristal) is assumed by Industrias Cosmic S.A. in order to position this brand as a reference of luxury and elegance.

En 2009, Pomd'or (Blanch Cristal) es asumida por Industrias Cosmic S.A. para posicionar esta marca como referente de lujo y elegancia.

**2010**

In 2010, through the acquisition of Stildux we incorporate the division of shower enclosures.

En 2010, mediante la adquisición de Stildux se incorpora la división de mamparas de ducha.





COSMIC. Bigues i Riells. Barcelona. Spain.



COSMIC. Gavà. Barcelona. Spain.

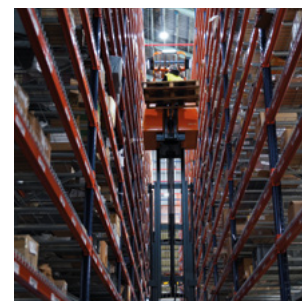

COSMIC. China.

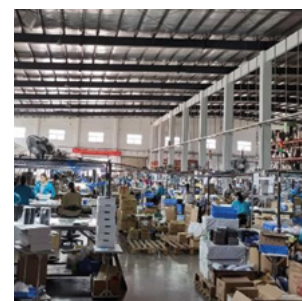

**2020**

In 2020 Cosmic became the Competence Center for bathroom Accessories for Roca Group.

En 2020 Cosmic se convierte en el Centro de Competencia de Accesorios de baño del Grupo Roca.

**2021**

In 2021 Cosmic gran opening of its new headquarters and showroom in Bigues i Riells and new warehouse in Gavà.

En 2021 Cosmic gran apertura de su nueva sede y showroom en Bigues i Riells y nuevo almacén en Gavà.

**2022**

In 2022 Cosmic migrated successfully to SAP all its business systems.

En 2022 Cosmic migra con éxito a SAP todos sus sistemas de negocio.

**2023**

In 2023 Cosmic empowered the unique brand and renewed the image, integrating all portfolios.

En 2023 Cosmic potencia la marca única y renueva la imagen, integrando todas las carteras.





Miquel de Mas



Xavier Claramunt



Carles Ferruz



Eugeni Quitllet



Martín Ruiz Azua



Ricard Ferrer



Àlex Armenter



Nahtrang



# The creators

## Los creadores

Over the years the Cosmic Studio has been designing and developing numerous collections that have become classics. It has also collaborated with and coordinated work by renowned designers.

A lo largo de la historia Cosmic Studio ha diseñado y desarrollado multitud de colecciones que se han convertido en clásicos, y ha colaborado y coordinado el trabajo de reconocidos diseñadores.



Cosmic Studio



# Showroom

Cosmic Showroom, situated at the central office of Industrias Cosmic, S.A.U., is a place to experience the contact with the product. Washbasins, bathtubs, cabinets, faucets and accessories...

Cosmic showroom es un espacio situado en la sede central de Industrias Cosmic, S.A.U. donde disfrutar de la experiencia del contacto con el producto. Lavabos, bañeras, mobiliario, griferías y accesorios...





























INDUSTRIAS COSMIC  
C/ESGUEIS S/N. LOCAL 1  
POL. IND. CAN BARRI  
08415 BIGUES I RIELLS  
BARCELONA SPAIN  
T. +34 938 654 277  
info@icosmic.com  
www.icosmic.com



# Index of fixings

## Índice de fijaciones

				
<b>Architect</b> (WJC205)	036		+	
<b>Architect S</b> (WJC235)	050			
<b>Bath Life</b> (WJC229)	074			
<b>Black &amp; White</b> (WJC238-WJC251)	080			
<b>Diabolo</b> (WJB275)	092		+	
<b>Duo</b> (WJB262-WJB264)	098			
<b>Eda</b> (WJP056)	110			
<b>Extreme</b> (WJC253)	116			
<b>Geyser</b> (WJC277)	124		+	
<b>Kubic</b> (WJP033)	138		+	
<b>Line</b> (WJB269)	152		+	
<b>Logic</b> (WJC226)	160			
<b>Metric</b> (WJP038)	172			
<b>Micra</b> (WJP047)	182			
<b>Next</b> (WJC215)	192		+	
<b>Start</b> (WJC419)	198			
<b>Stick</b> (WJB276)	208			
<b>The Grid</b> (WJC268)	218			



Drill hole installation.  
Instalación con taladro.



Installation with SmartFix adhesive.  
Instalación con adhesivo SmartFix.





Installation with QuickFix adhesive.  
Instalación con adhesivo QuickFix.



# Index of finishes

## Índice de acabados

	001 CHROME CROMO	002 GLOSSY STAINLESS STEEL INOX BRILLO	003/021 MATTE STAINLESS STEEL INOX MATE	026/036 MATTE BLACK NEGRO MATE	065 MATTE WHITE BLANCO MATE	028 MATTE GREY GRIS MATE	040 BRUSHED GOLD PVD PVD ORO CEPILLADO	054 BRUSHED COPPER PVD PVD COBRE CEPILLADO	055 BRUSHED BLACK PVD PVD NEGRO CEPILLADO
 <b>Architect</b> (WJC205)	●								
<b>Architect</b>  (WJC235)	●		●	●	●		●	●	●
<b>Bath Life</b> (WJC229)	●								
<b>Black &amp; White</b> (WJC238-WJC251)	●			●	●				
<b>Diabolo</b> (WJB275)	●			●	●				
<b>Duo</b> (WJB262-WJB264)	●								
<b>Eda</b> (WJP056)	●			●					
<b>Extreme</b> (WJC253)	●								
<b>Geyser</b> (WJC277)				●	●				
<b>Kubic</b> (WJP033)	●			●					
<b>Line</b> (WJB269-WJB350)	●		●	●	●				
<b>Logic</b> (WJC226)		●	●	●					
<b>Metric</b> (WJP038)	●		●	●					
<b>Micra</b> (WJP047)	●			●					
<b>Next</b> (WJC215)	●			●					
<b>Start</b> (WJC419)	●			●					
<b>Stick</b> (WJB276)	●			●	●				
<b>The Grid</b> (WJC268)	●			●	●				
 <b>L'Avenir</b> (WJC216)									
<b>Saku</b> (WJC252)				●	●	●			
<b>Flat</b> (WJC512)	●			●					
<b>Saona</b> (WJC219)									
<b>Lido</b> (WJC213)									





# L'Avenir

Design by Ricard Ferrer + OiKo





# L'Avenir

Design by Ricard Ferrer + OiKo



**L'Avenir is a collection of accessories by Industrias COSMIC, designed by Ricard Ferrer and developed in conjunction with OiKo Design Office. The use of up to 96% recycled plastics in its production results in the creation of a new material with colours and textures never seen before.**

---

L'Avenir, es una colección de complementos de COSMIC diseñada por Ricard Ferrer y desarrollada conjuntamente con OiKo design Office. El empleo en su fabricación de hasta un 96% de plásticos reciclados resulta en la creación de un nuevo material con colores y texturas nunca vistos.





**10**  
YEARS GUARANTEE  
AÑOS GARANTÍA  
—  
**COSMIC**

L'Avenir introduces a new form of awareness to COSMIC by using recovered materials and textures that redefine the value of objects, calling for a new culture of responsible, sustainable consumption. L'Avenir arose from the need to declare a firm environmental commitment, acknowledging that daily objects should be designed by using materials and resources responsibly, and creating a circle that should be followed and which leads to a balanced future.

L'Avenir introduce en COSMIC, una nueva sensibilidad, a partir de materiales recuperados y texturas que redefinen el valor de los objetos, apelando a una nueva cultura de consumo responsable y sostenible. L'Avenir se plantea desde la necesidad asumir un compromiso firme con el medio ambiente, entendiendo que los objetos cotidianos deben diseñarse haciendo un uso responsable de materiales y recursos, un círculo que debe transitarse y que apunta a un futuro en equilibrio.



# L'Avenir

Design by Ricard Ferrer + OiKo





# A sustainable production process

## Un proceso de producción sostenible

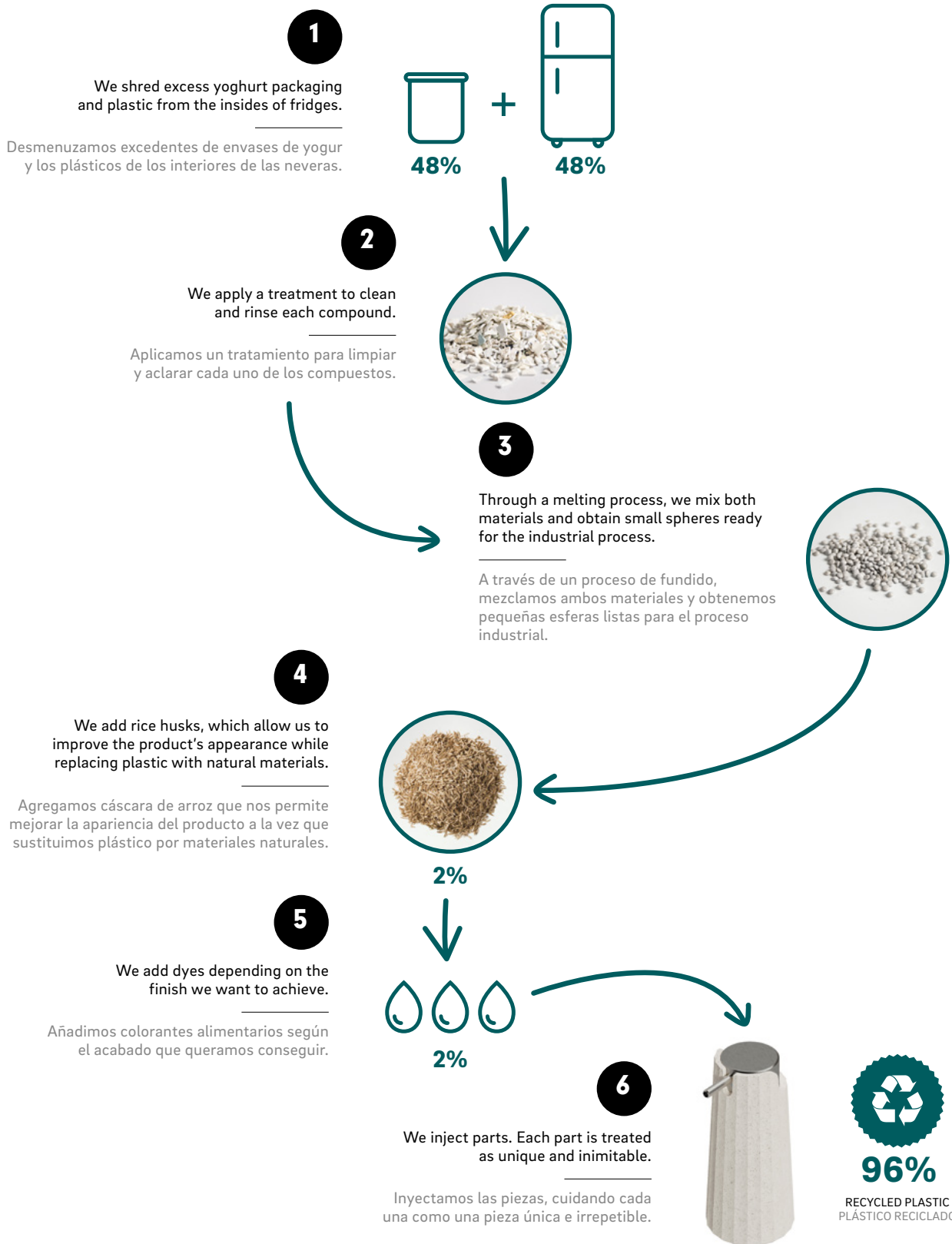

# L'Avenir

Design by Ricard Ferrer + OiKo

AxBxC CM  
INCH AxBxC



**081**  
WHITE NATUR  
BRUSHED STEEL  
BLANCO NATUR  
INOX CEPILLADO



**083**  
SAND NATUR  
BRUSHED GOLD PVD  
ARENA NATUR  
ORO CEPILLADO PVD

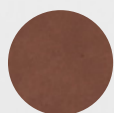

**082**  
RUSSET NATUR  
BRUSHED COPPER PVD  
TERRACOTA NATUR  
COBRE CEPILLADO PVD

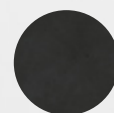

**080**  
BLACK NATUR  
BRUSHED BLACK PVD  
NEGRO NATUR  
NEGRO CEPILLADO PVD



# Free standing accessories | Complementos



## FREE STANDING SOAP DISPENSER

DOSIFICADOR ENCIMERA

7,5X9,2X16,6 CM  
2,95X3,62X6,54 IN

(200ML)



WJC216A0004081  
WHITE NATUR / BLANCO NATUR



WJC216A0004083  
SAND NATUR / ARENA NATUR



WJC216A0004082  
RUSSET NATUR / TERRACOTA  
TEXTURIZADO



WJC216A0004080  
BLACK NATUR / NEGRO NATUR



## FREE STANDING BRUSH HOLDER

PORTACEPILLOS ENCIMERA

7,4X7,4X13,3 CM  
2,91X2,91X5,24 IN



WJC216A0053081  
WHITE NATUR / BLANCO NATUR



WJC216A0053083  
SAND NATUR / ARENA NATUR



WJC216A0053082  
RUSSET NATUR / TERRACOTA  
TEXTURIZADO



WJC216A0053080  
BLACK NATUR / NEGRO NATUR



## FREE STANDING SOAP DISH

JABONERA ENCIMERA

14,9X8,8X2,9 CM  
5,87X3,46X1,14 IN



WJC216A0034081  
WHITE NATUR / BLANCO NATUR



WJC216A0034083  
SAND NATUR / ARENA NATUR



WJC216A0034082  
RUSSET NATUR / TERRACOTA  
TEXTURIZADO



WJC216A0034080  
BLACK NATUR / NEGRO NATUR



## FREE STANDING TOILET BRUSH

ESCOBILLERO SUELO

10,6X10,6X41,8 CM  
4,17X4,17X16,46 IN



WJC216A0001081  
WHITE NATUR / BLANCO NATUR



WJC216A0001083  
SAND NATUR / ARENA NATUR



WJC216A0001082  
RUSSET NATUR / TERRACOTA  
TEXTURIZADO



WJC216A0001080  
BLACK NATUR / NEGRO NATUR



# Lido

Design by Cosmic Studio



# Free standing accessories | Complementos

AxBxC CM  
INCH AxBxC



**5**  
YEARS GUARANTEE  
AÑOS GARANTÍA  
**COSMIC**

**B** CONSULT SPECIAL CONDITIONS\*  
CONSULTAR CONDICIONES ESPECIALES\*

△◇  
FREE STANDING SOAP  
DISPENSER  
DOSIFICADOR ENCIMERA

7,8X7,8X17,2 CM  
3,07X3,07X6,77 IN

(300ML)



**NEW** WJC213A0004420 **B**  
BLUISH GREEN / BLUISH GREEN



**NEW** WJC213A0004345 **B**  
SMOKE GREY / SMOKE GREY

◇  
FREE STANDING BRUSH  
HOLDER  
PORTACEPILLOS ENCIMERA

7,5X7,5X10 CM  
2,95X2,95X3,94 IN



**NEW** WJC213A0051420 **B**  
BLUISH GREEN / BLUISH GREEN



**NEW** WJC213A0051345 **B**  
SMOKE GREY / SMOKE GREY

\* Limited discount  
\* Descuento limitado



Lido

025



# Saona

Design by Cosmic Studio



# Free standing accessories | Complementos



**5**  
YEARS GUARANTEE  
AÑOS GARANTÍA  
**COSMIC**



**B** CONSULT SPECIAL CONDITIONS\*  
CONSULTAR CONDICIONES ESPECIALES\*

**1**  
FREE STANDING SOAP  
DISPENSER  
DOSIFICADOR ENCIMERA

8,5X8,5X14 CM  
3,35X3,35X5,51 IN

(350ML)



**NEW** WJC219A0004222 **B**  
SAND / SAND



**NEW** WJC219A0004403 **B**  
BLOSSOM / BLOSSOM



**NEW** WJC219A0004418 **B**  
OLIVE / OLIVE

**1**  
FREE STANDING BRUSH  
HOLDER  
PORTACEPILLOS ENCIMERA

8,5X8,5X11,5 CM  
3,35X3,35X4,53 IN



**NEW** WJC219A00051222 **B**  
SAND / SAND



**NEW** WJC219A00051403 **B**  
BLOSSOM / BLOSSOM



**NEW** WJC219A00051418 **B**  
OLIVE / OLIVE

**1**  
FREE STANDING SOAP DISH  
JABONERA ENCIMERA

3X9,5X13 CM  
1,18X3,74X5,12 IN



**NEW** WJC219A00034222 **B**  
SAND / SAND



**NEW** WJC219A00034403 **B**  
BLOSSOM / BLOSSOM



**NEW** WJC219A00034418 **B**  
OLIVE / OLIVE

**1**  
FREE STANDING TOILET  
BRUSH  
ESCOBILLERO SUELO

9,5X9,5X15,5 CM  
3,74X3,74X6,1 IN



**NEW** WJC219A0001222 **B**  
SAND / SAND



**NEW** WJC219A0001403 **B**  
BLOSSOM / BLOSSOM



**NEW** WJC219A0001418 **B**  
OLIVE / OLIVE

\* Limited discount  
\* Descuento limitado

# Saku

Design by **Ricard Ferrer**



**Saku** Design by Ricard Ferrer





Saku has successfully passed the high demanding tests of long last durability and resistance to extreme uses (static charge or impact testing) to assure long last durability of the product.

Toda la gama Saku ha superado con éxito exigentes tests de durabilidad y resistencia a usos extremos (cargas estáticas o test de impacto), para asegurar una larga vida al producto.



FEATURES / CARACTERÍSTICAS

Complements in PMMA (Polymethyl methacrylate), coated in transparent paint with a gummy finish.

Complementos realizados en PMMA (poli metil metacrilato) recubiertos con pintura transparente en acabado gomoso.

FINISHES / ACABADOS



**025**  
Soft white  
Blanco soft



**027**  
Soft stone  
Piedra soft



**028**  
Soft gray  
Gris soft



**026**  
Soft black  
Negro soft



△  
FREE STANDING SOAP  
DISPENSER  
DOSIFICADOR ENCIMERA

6,5X8X19 CM  
2,56X3,15X7,48 IN

(300ML)



WJC252A0004025  
SOFT WHITE / BLANCO SOFT



WJC252A0004027  
SOFT STONE / PIEDRA SOFT



WJC252A0004028  
SOFT GRAY / GRIS SOFT



WJC252A0004026  
SOFT BLACK / NEGRO SOFT

△  
FREE STANDING BRUSH  
HOLDER  
PORTACEPILLOS ENCIMERA

11X8X13 CM  
4,33X3,15X5,12 IN



WJC252A0052025  
SOFT WHITE / BLANCO SOFT



WJC252A0052027  
SOFT STONE / PIEDRA SOFT



WJC252A0052028  
SOFT GRAY / GRIS SOFT



WJC252A0052026  
SOFT BLACK / NEGRO SOFT

△  
FREE STANDING SOAP DISH  
JABONERA ENCIMERA

13X10,5X3,5 CM  
5,12X4,13X1,38 IN



WJC252A0032025  
SOFT WHITE / BLANCO SOFT



WJC252A0032027  
SOFT STONE / PIEDRA SOFT



WJC252A0032028  
SOFT GRAY / GRIS SOFT



WJC252A0032026  
SOFT BLACK / NEGRO SOFT

△  
FREE STANDING TOILET  
BRUSH  
ESCOBILLERO SUELO

10,5X9X38,5 CM  
4,13X3,54X15,16 IN



WJC252A0000025  
SOFT WHITE / BLANCO SOFT



WJC252A0000027  
SOFT STONE / PIEDRA SOFT



WJC252A0000028  
SOFT GRAY / GRIS SOFT



WJC252A0000026  
SOFT BLACK / NEGRO SOFT





# Flat

Design by **Cosmic Studio**



Easy installation  
without drilling

Fácil instalación  
sin taladro



Bonded with  
high adhesion  
adhesive (3M)

Fijación con  
adhesivo de alta  
adherencia (3M)



Quick, easy, silent  
installation

Montaje sin ruido,  
fácil y rápido



Static load  
of 5 kg

Carga estática  
de 5 KG



Do not use on  
painted surfaces  
and gypsum walls

No usar en  
superficies pintadas  
ni en paredes rugosas

**QUICK  
FIX**

# Free standing accessories | Complementos



Ultra slim for a small footprint in the bathroom.

Ultrafino para ocupar poco espacio en el baño.

**B** CONSULT SPECIAL CONDITIONS\*  
CONSULTAR CONDICIONES ESPECIALES\*

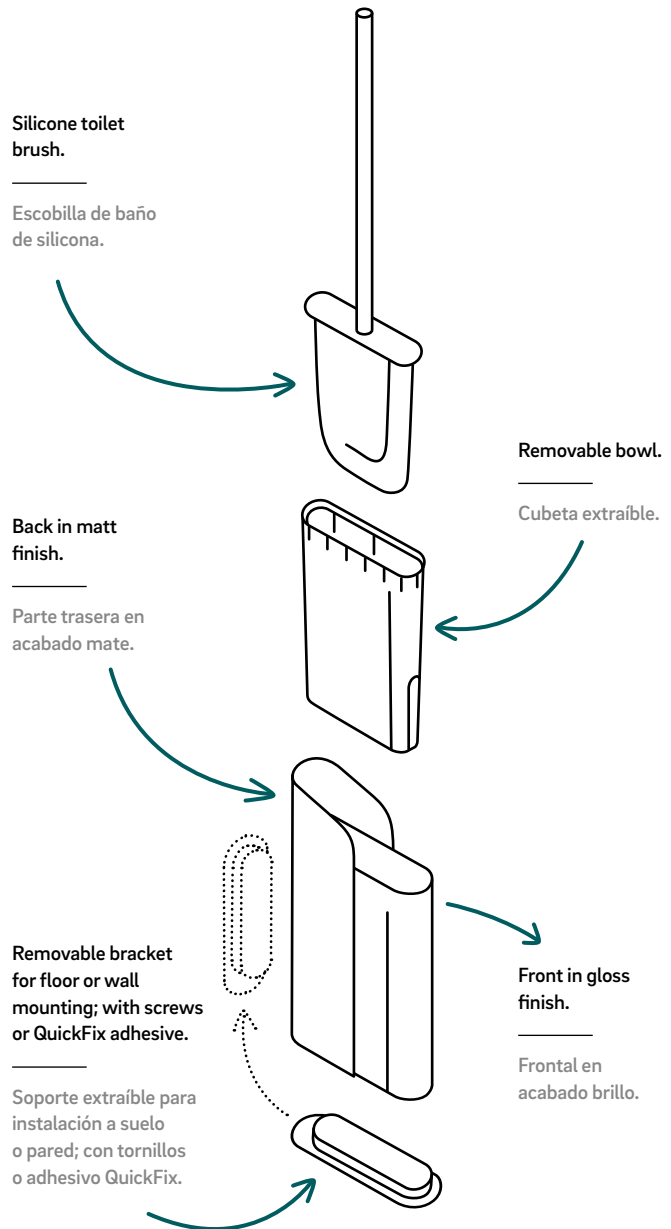

△△⊙  
FREE-STANDING OR WALL  
TOILET BRUSH  
ESCOBILLERO SUELO/PARED  
3,8X10,7X38,7 CM  
1,5X4,21X15,24 IN

DUAL QUICKFIX



\* Limited discount  
\* Descuento limitado



# Architect

Design by **Cosmic Studio**





# Architect

Design by Cosmic Studio



A multitude of pieces come out of architectonic forms that dominate with their resistance. A comprehensive collection of accessories with a timeless and elegant design.

---

De las formas arquitectónicas surgen multitud de piezas que destacan por su resistencia. Colección completa con un diseño atemporal y elegante.





**DUAL SYSTEM / SISTEMA DUAL**

Our updated Architect collection now includes a dual installation system for installing bathroom accessories with or without a drill. Smart-fix adhesive, designed exclusively for our firm, means that bathroom accessories can be installed without drilling holes in the wall.

La colección Architect presenta como novedad el sistema de instalación dual, que permite sujetar los accesorios de baño con y sin taladros. Con el adhesivo Smart-fix, elaborado en exclusiva para la firma, se facilita el montaje sin la necesidad de hacer agujeros en la pared.



**FEATURES / CARACTERÍSTICAS**

Easy installation: double pitch screw. Hidden attachments. Anti-corrosion.

Fácil instalación: tornillo de doble paso. Fijaciones ocultas. Anticorrosión.



**Architect** has successfully passed the high demanding tests of long last durability and resistance to extreme uses (static charge or impact testing) to assure long last durability of the product. All products come with 10 years warranty, except for waste bins and stools, which come with 3 years warranty.

Toda la gama **Architect** ha superado con éxito exigentes tests de durabilidad y resistencia a usos extremos (cargas estáticas o test de impacto), para asegurar una larga vida al producto. Todos los artículos tienen 10 años de garantía a excepción de las papeleras y los taburetes que tienen una garantía de 3 años.



**SMART  
FIX**



Easy installation without drilling

Fácil instalación sin taladro

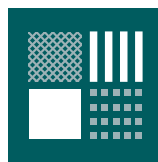

Works with different surfaces\*

Efectivo en diferentes superficies\*



Static load of 10 kg

Carga estática de 10 Kg



Removable accessories

Accesorios removibles



Quick, easy, silent installation

Montaje sin ruido, fácil y rápido

\* Ceramic, porcelain, glazed surfaces, compact marble, even surfaces with roughness up to 0.5 mm thickness.

\* Cerámica, porcelana, materiales vitrificados o mármoles compactos, e incluso superficies con una rugosidad de hasta 0,5 milímetros de espesor.



Dual SmartFix products require the SmartFix gluing kit ref. WJC341R1185000  
Los productos Dual SmartFix requieren del kit de encolado SmartFix ref. WJC341R1185000



# Architect

Design by Cosmic Studio



⊙  
GLOVE HOOK  
PORTAGUANTES  
2X3,5X2 CM  
0,79X1,38X0,79 IN



WJC205A0020001  
CHROME / CROMO

○  
HOOK  
COLGADOR  
2,5X4,3X5,1 CM  
0,98X1,69X2,01 IN



WJB005A0102002  
BRIGHT / INOX BRILLO

⊙  
HOOK  
COLGADOR  
3,5X5X3,5 CM  
1,38X1,97X1,38 IN



WJC205A0021001 **S**  
CHROME / CROMO

⊙  
HOOK  
COLGADOR  
4X5,8X4 CM  
1,57X2,28X1,57 IN



DUAL SMARTFIX

**NEW** WJC205A1021001  
CHROME / CROMO

⊙  
HOOK  
COLGADOR  
5,5X6X5,5 CM  
2,17X2,36X2,17 IN



WJC235A0021001 **S**  
CHROME / CROMO

⊙  
HOOK  
COLGADOR  
5X3X5 CM  
1,97X1,18X1,97 IN



WJC205A0121001  
CHROME / CROMO



Dual SmartFix products require the SmartFix gluing kit ref. WJC341R1185000  
Los productos Dual SmartFix requieren del kit de encolado SmartFix ref. WJC341R1185000

ALTA DISPONIBILIDAD.  
HIGH AVAILABILITY.

DOUBLE HOOK  
COLGADOR DOBLE

18,5X5,5X4 CM  
7,28X2,17X1,57 IN



WJC205A0022001  
CHROME / CROMO

FREE STANDING SOAP DISPENSER  
DOSIFICADOR ENCIMERA

6,2X8,1X18,3 CM  
2,44X3,19X7,2 IN

(240 ML)



WJC205A0004001 S  
CHROME / CROMO

WALL SOAP DISPENSER  
DOSIFICADOR PARED

11,9X13,4X24 CM  
4,69X5,28X9,45 IN

(1500 ML)



WJC290A0025002  
GLOSSY STAINLESS STEEL / INOX BRILLO

WALL SOAP DISPENSER  
DOSIFICADOR PARED

6,2X9,5X17,6 CM  
2,44X3,74X6,93 IN

DUAL SMARTFIX  
(240 ML)



NEW WJC205A1003001 S  
CHROME / CROMO

FREE STANDING BRUSH HOLDER  
PORTACEPILLOS ENCIMERA

6,2X6,2X13,5 CM  
2,44X2,44X5,31 IN



WJC205A0051001  
CHROME / CROMO

WALL TOOTHBRUSH HOLDER  
PORTACEPILLOS PARED

6,2X8,7X13,4 CM  
2,44X3,43X5,28 IN

DUAL SMARTFIX



NEW WJC205A1053001  
CHROME / CROMO



**AUTOMATIC DISPENSER**  
DOSIFICADOR AUTOMATICO

10,1X10,9X22,2 CM  
3,98X4,29X8,74 IN



**WJC290A6510000**  
BLACK / NEGRO

**AUTOMATIC DISPENSER**  
DOSIFICADOR AUTOMATICO

11X12X26 CM  
4,33X4,72X10,24 IN



**WJC290A6509000**  
MATTE SILVER / PLATA MATE

○  
**SHOWER SOAP DISH**  
JABONERA DE DUCHA

20X12X2,5 CM  
7,87X4,72X0,98 IN



**WJC205A0039002**  
GLOSSY / INOX BRILLO

⊗△  
**SHOWER SOAP DISH**  
JABONERA DE DUCHA

30X12X4 CM  
11,81X4,72X1,57 IN



**WJC251A0049051**  
CHROME-WHITE / CROMO-BLANCO



**WJC251A0049061**  
CHROME-BLACK / CROMO-NEGRO

⊙  
**SHOWER SOAP DISH**  
JABONERA DE DUCHA

30X12X6,5 CM  
11,81X4,72X2,56 IN



**WJC205A0049001**  
CHROME / CROMO

⊙  
**SHOWER SOAP DISH**  
JABONERA DE DUCHA

40X12X10,5 CM  
15,75X4,72X4,13 IN



**WJC205A0048001**  
CHROME / CROMO

○  
**CORNER SHOWER BASKET**  
JABONERA DE DUCHA RINCÓN

18X18X2,5 CM  
7,09X7,09X0,98 IN



**WJC205A0030002**  
GLOSSY / INOX BRILLO

⊙  
**CORNER SHOWER BASKET**  
JABONERA DE DUCHA RINCÓN

20X20X6,5 CM  
7,87X7,87X2,56 IN



**WJC205A0050001**  
CHROME / CROMO

○  
**TISSUE BOX**  
CAJA KLEENEX

25,8X9X12,7 CM  
10,16X3,54X5 IN



**NEW** **WJC205A1020001**  
CHROME / CROMO

△  
**HAIR DRYER**  
SECADOR DE PELO

25X11,5X45 CM  
9,84X4,53X17,72 IN

(IP24 100 (IPX0))



**WJC290A0003000**  
BLACK-CHROME / NEGRO-CROMO



Dual SmartFix products require the SmartFix gluing kit ref. WJC341R1185000  
 Los productos Dual SmartFix requieren del kit de encolado SmartFix ref. WJC341R1185000

**S** ALTA DISPONIBILIDAD.  
 HIGH AVAILABILITY.

○△◆

**WALL MAGNIFYING MIRROR WITH ADJUSTABLE LED LIGHT**

ESPEJO AUMENTO DE PARED CON LUZ LED REGULABLE

20,5X42,9X20,5 CM  
 8,07X16,89X8,07 IN

(LED)(X5)(4.5W 100-240V)



**WJC292A0084001**  
 CHROME / CROMO



**WJC292A0084036**  
 MATTE BLACK / NEGRO MATE

◎△◆

**WALL MAGNIFYING MIRROR**  
 ESPEJO DE AUMENTO PARED

20X31X20 CM  
 7,87X12,2X7,87 IN

(X5)



**WJC235A0085001** **S**  
 CHROME / CROMO

○△◆

**WALL MAGNIFYING MIRROR**

ESPEJO DE AUMENTO PARED

41,1X45,5X27,9 CM  
 16,18X17,91X10,98 IN

(X5)



**WJC292A0083001**  
 CHROME / CROMO



**WJC292A0083036**  
 MATTE BLACK / NEGRO MATE

◎

**TOWEL RACK**  
 TOALLERO

22,5X9X4,5 CM  
 8,86X3,54X1,77 IN

DUAL SMARTFIX



**WJC205A0067001**  
 CHROME / CROMO

◎

**TOWEL RACK**  
 TOALLERO

5,5X40X5,5 CM  
 2,17X15,75X2,17 IN



**WJC205A0069001**  
 CHROME / CROMO

◎

**TOWEL RACK**  
 TOALLERO

41,5X8,5X4,5 CM  
 16,34X3,35X1,77 IN

DUAL SMARTFIX



**WJC205A0064001**  
 CHROME / CROMO

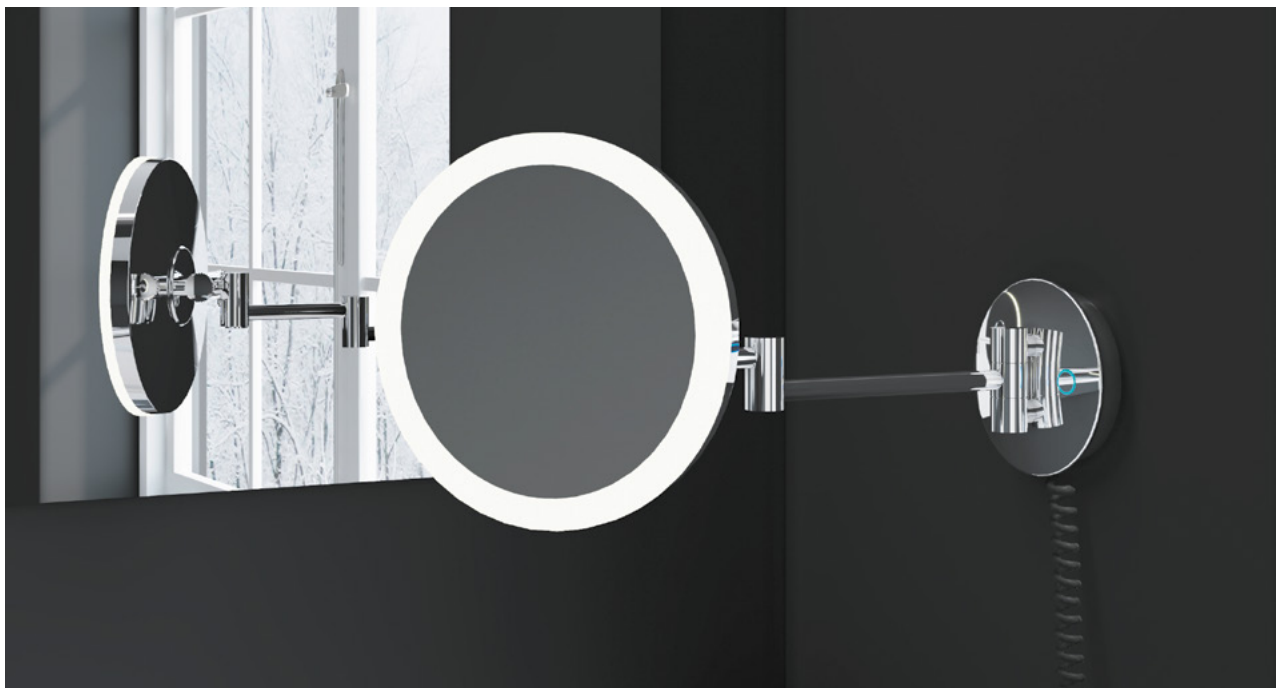

# Architect

Design by **Cosmic Studio**

AxBxC CM  
INCH AxBxC



⊙  
TOWEL RACK  
TOALLERO  
59X8,5X4,5 CM  
23,23X3,35X1,77 IN



DUAL SMARTFIX

WJC205A0065001  
CHROME / CROMO

⊙  
TOWEL RACK  
TOALLERO  
78X8,5X4,5 CM  
30,71X3,35X1,77 IN



DUAL SMARTFIX

WJC205A0066001  
CHROME / CROMO

⊙  
DOUBLE TOWEL RACK  
TOALLERO DOBLE  
59X13X4,5 CM  
23,23X5,12X1,77 IN



DUAL SMARTFIX

WJC205A0061001  
CHROME / CROMO

⊙  
SWIVEL TOWEL RACK  
TOALLERO GIRATORIO  
41,5X4X9 CM  
16,34X1,57X3,54 IN



WJC205A0074001  
CHROME / CROMO



Dual SmartFix products require the SmartFix gluing kit ref. WJC341R1185000  
Los productos Dual SmartFix requieren del kit de encolado SmartFix ref. WJC341R1185000

ALTA DISPONIBILIDAD.  
HIGH AVAILABILITY.

⊙  
TOWEL RING  
TOALLERO ARO

22,5X16X16 CM  
8,86X6,3X6,3 IN

DUAL SMARTFIX



WJC205A0072001  
CHROME / CROMO

⊙  
TOWEL RING  
TOALLERO ARO

22,5X8,5X12 CM  
8,86X3,35X4,72 IN

DUAL SMARTFIX



WJC205A0071001  
CHROME / CROMO

⊙  
TOWEL RACK SHELF  
TOALLERO ESTANTE

54X30,5X6,5 CM  
21,26X12,01X2,56 IN

DUAL SMARTFIX



WJC205A0068001  
CHROME / CROMO

⊙  
TOWEL RACK SHELF  
TOALLERO ESTANTE

57,5X26X9,5 CM  
22,64X10,24X3,74 IN

DUAL SMARTFIX



WJC205A1068001  
CHROME / CROMO



○

**GRAB BAR**  
ASA BAÑERA

30X7X6 CM  
11,81X2,76X2,36 IN



WJC205A0010001  
CHROME / CROMO

(Ø 22MM)

○

**GRAB BAR**  
ASA BAÑERA

45X7X6 CM  
17,72X2,76X2,36 IN



WJC205A0011001  
CHROME / CROMO

○

**GRAB BAR**  
ASA BAÑERA

60X7X6 CM  
23,62X2,76X2,36 IN



WJC205A0012001  
CHROME / CROMO

○

**RIGHT BATH GRAB BAR**  
ASA BAÑERA DERECHA

40X7X40 CM  
15,75X2,76X15,75 IN

(90°)



WJC205A0015001  
CHROME / CROMO

○

**RIGHT BATH GRAB BAR**  
ASA BAÑERA DERECHA

49X7X24 CM  
19,29X2,76X9,45 IN

(135°)



WJC205A0013001  
CHROME / CROMO

○

**LEFT BATH GRAB BAR**  
ASA BAÑERA IZQUIERDA

40X7X40 CM  
15,75X2,76X15,75 IN

(90°)



WJC205A0016001  
CHROME / CROMO

○

**LEFT BATH GRAB BAR**  
ASA BAÑERA IZQUIERDA

49X7X24 CM  
19,29X2,76X9,45 IN

(135°)



WJC205A0014001  
CHROME / CROMO

○

**GRAB BAR/RIGHT SOAP DISH**  
ASA BAÑERA/REJILLA DERECHA

50X12,8X24 CM  
19,69X5,04X9,45 IN



WJC205A0026001  
CHROME / CROMO

⊙

**HINGED GRAB BAR**  
ASA ABATIBLE

75X10X30 CM  
29,53X3,94X11,81 IN



WJC205A0017001  
CHROME / CROMO

⊙

**HINGED GRAB BAR WITH PAPER  
HOLDER**  
ASA ABATIBLE CON PORTARROLLOS

75X10X30 CM  
29,53X3,94X11,81 IN



WJC205A0018001  
CHROME / CROMO



Dual SmartFix products require the SmartFix gluing kit ref. WJC341R1185000  
Los productos Dual SmartFix requieren del kit de encolado SmartFix ref. WJC341R1185000

ALTA DISPONIBILIDAD.  
HIGH AVAILABILITY.

⊙△  
PAPER HOLDER WITH COVER  
PORTARROLLO CON TAPA

14,5X11,5X8 CM  
5,71X4,53X3,15 IN

DUAL QUICKFIX



WJC205A0059001  
CHROME / CROMO

⊙  
PAPER HOLDER WITHOUT COVER  
PORTARROLLO SIN TAPA

16X9X4,5 CM  
6,3X3,54X1,77 IN

DUAL SMARTFIX



WJC205A0058001  
CHROME / CROMO

⊙  
DOUBLE PAPER HOLDER WITHOUT COVER  
PORTARROLLO DOBLE SIN TAPA

24,5X9X4,5 CM  
9,65X3,54X1,77 IN

DUAL SMARTFIX



WJC205A0057001  
CHROME / CROMO

⊙  
VERTICAL PAPER HOLDER  
PORTARROLLO VERTICAL

5,7X9X16,7 CM  
2,24X3,54X6,57 IN

DUAL SMARTFIX



WJC205A0096001  
CHROME / CROMO



○  
FREE STANDING TOILET BRUSH  
ESCOBILLERO SUELO

9,2X9,2X38,6 CM  
3,62X3,62X15,2 IN

⊙○△  
FREE STANDING TOILET BRUSH  
ESCOBILLERO SUELO

9X9X38,7 CM  
3,54X3,54X15,24 IN

○  
WALL TOILET BRUSH HOLDER  
ESCOBILLERO PARED

9,2X9,2X38,6 CM  
3,62X3,62X15,2 IN



WJC226A0001002 <sup>S</sup>  
GLOSSY STAINLESS STEEL / INOX BRILLO



WJC235A0001001 <sup>S</sup>  
CHROME / CROMO



WJC226A0097002 <sup>S</sup>  
GLOSSY STAINLESS STEEL / INOX BRILLO



⊙○△  
WALL TOILET BRUSH HOLDER  
ESCOBILLERO PARED

9X11,5X38,7 CM  
3,54X4,53X15,24 IN



WJC235A0000001 **S**  
CHROME / CROMO

○△  
FREE-STANDING OR WALL TOILET  
BRUSH

ESCOBILLERO  
SUELO/PARED

13,7X13,7X35,3 CM  
5,39X5,39X13,9 IN



**NEW** WJC292A0000001  
CHROME / CROMO



**NEW** WJC292A0000036  
MATTE BLACK / NEGRO MATE

⊙○△  
FREE-STANDING OR WALL TOILET  
BRUSH

9X10X43 CM  
3,54X3,94X16,93 IN

DUAL SMARTFIX



WJC251A0000001  
CHROME / CROMO

○  
TOILET PAPER DISPENSER  
DISPENSADOR PAPEL HIGIÉNICO

25X12,9X25 CM  
9,84X5,08X9,84 IN



WJC290A0026002  
GLOSSY STAINLESS STEEL / INOX BRILLO

○  
TOILET TISSUE DISPENSER  
DISPENSADOR PAPEL TOALLA

27,5X13,2X33 CM  
10,83X5,2X12,99 IN



WJC290A0027002  
GLOSSY STAINLESS STEEL / INOX BRILLO

△  
HYGIENIC PLASTIC  
BAGS DISPENSER

PORTABOLSITAS  
HIGIÉNICAS

9,8X2,7X13,7 CM  
3,86X1,06X5,39 IN



WJC290A0028001  
CHROME / CROMO



WJC290A0028036  
MATTE BLACK / NEGRO MATE

○△  
WASTE BIN  
PAPELERA

17X17X24,5 CM  
6,69X6,69X9,65 IN

(3L)



WJC205A0702002  
GLOSSY STAINLESS STEEL / INOX BRILLO

○△  
WASTE BIN  
PAPELERA

20,5X20,5X28,5 CM  
8,07X8,07X11,22 IN

(5L)



WJC205A0703002  
GLOSSY STAINLESS STEEL / INOX BRILLO

○△  
WASTE BIN  
PAPELERA

20,5X20,5X26 CM  
8,07X8,07X10,24 IN

(5L)



WJC235A0002001  
CHROME / CROMO



WJC277A0002036  
MATTE BLACK / NEGRO MATE

○△  
WASTE BIN  
PAPELERA

25X25X40 CM  
9,84X9,84X15,75 IN

(12L)



WJC205A0704002  
GLOSSY STAINLESS STEEL / INOX BRILLO



Dual SmartFix products require the SmartFix gluing kit ref. WJC341R1185000  
Los productos Dual SmartFix requieren del kit de encolado SmartFix ref. WJC341R1185000

**S** ALTA DISPONIBILIDAD.  
HIGH AVAILABILITY.

⊕△  
SHOWER SEAT  
ASIENTO DE DUCHA

37,2X37,7X6,5 CM  
14,65X14,84X2,56 IN



WJC205A0034006  
BLACK / NEGRO

○△  
STOOL  
TABURETE

31X31X40 CM  
12,2X12,2X15,75 IN



WJC205A0006065  
CHROME-MATTE WHITE / CROMO-  
BLANCO MATE



WJC205A0006036  
CHROME-MATTE BLACK / CROMO-  
NEGRO MATE

SMARTFIX KIT  
SMARTFIX KIT ENCOLAR

10 GR.



**NEW** WJC341R1185000



Architect

049



# Architect



Design by **Cosmic Studio**





Go to the next level





Cosmic is proud to present **Architect S+**, a complete collection with over 25 different accessories designed to offer maximum functionality. This new proposal stands out for the brand-new, ultra-stable bracket system incorporated into many of the pieces. Architect S+ is safe, superior, sustainable and strong: four values close to Cosmic's heart. Because Cosmic is Innovation's Mind.

Cosmic presenta **Architect S+**, una completa colección con más de 25 accesorios diferentes pensados para ofrecer la máxima funcionalidad. La nueva propuesta destaca por incorporar en muchas de las piezas un sistema de soporte completamente nuevo, de una fijación absoluta. Architect S+ es segura, superior, sostenible y resolutive, los cuatro valores insignia de Cosmic. Porque Cosmic es Innovation's Mind.





**Mobile holder.**  
A useful addition to your  
day-to-day life.

Soporte para teléfono móvil.  
Muy útil en tu vida cotidiana.





Shower soap dish with built-in shower squeegee hidden in the base, ready to use. Can be taken apart for cleaning. Anodised aluminium shelf.

Jabonera que incorpora un limpia mamparas, oculto en la base y listo para su uso. Extraíble para una mejor limpieza. Estante de aluminio anodizado.

Soap level indicator.  
Dispenser button at the bottom.  
Anti-drip system.  
Large capacity (400 ml).  
Easy soap replacement system.

Indicador de nivel de jabón.  
Accionado por pulsador inferior.  
Sistema anti goteo.  
Gran capacidad (400 ml).  
Fácil reposición del jabón.





**400  
ml**



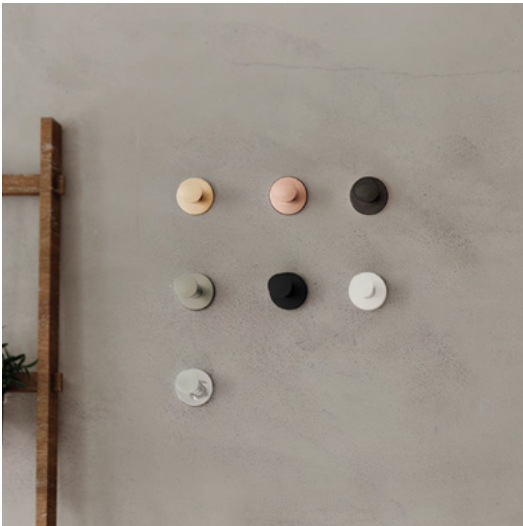

## New finishes Nuevos acabados

This makes for a total of seven finishes, including three brushed PVD finishes. PVD is one of the most revolutionary treatments in recent years thanks to the variety of colours available and its lasting results, which offer improved resistance to abrasion, scratching and corrosion.

Un total de 7 acabados, entre ellos 3 acabados cepillados en PVD. El PVD es uno de los tratamientos más revolucionarios en los últimos tiempos gracias a la variedad de colores que ofrece y a sus resultados más duraderos con una mayor resistencia a la abrasión, a las ralladuras y a la corrosión.

**Chrome** is a must in any catalogue and is the quintessential finish in the world of accessories. It offers durability, protects against corrosion, facilitates the cleaning process and boasts great versatility, allowing designers to create more varied, original designs.

El **chromo** como un "must" en cualquier catálogo, es el acabado por excelencia en el mundo del accesorio. Aporta durabilidad, protege contra la corrosión, facilita el proceso de limpieza y ofrece una gran versatilidad permitiendo crear diseños más variados y originales.



**001**  
CHROME  
CROMO



**036**  
BLACK MATT  
NEGRO MATE



**065**  
MATT WHITE  
BLANCO MATE

**Matte finishes** offer an alternative that is particularly on-trend in the interior design industry, providing parts with a resistant, lasting finish with a pleasing feel.

Los **acabados mate**, ofrecen una alternativa muy en tendencia en el sector del interiorismo proporcionando a las piezas un acabado resistente, duradero, y muy agradable al tacto.



## Accessories | Accesorios

Cosmic is reviving one of the classics with an improved version of the **brushed stainless steel** finish that was very popular among advisors. With a smooth, uniform brushing technique, this innovation comes to life on a classic finish.

Cosmic revive uno de los clásicos con una versión mejorada del acabado **inox cepillado**, muy popular entre prescriptores. Con un cepillado suave y uniforme, es innovación sobre un acabado clásico.



**003**  
BRUSHED STEEL  
INOX CEPILLADO

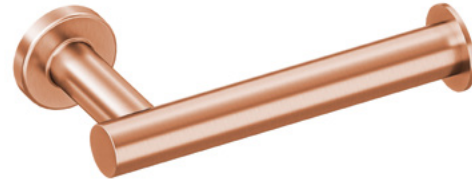

**054**  
BRUSHED COPPER PVD  
COBRE CEPILLADO PVD



**040**  
BRUSHED GOLD PVD  
ORO CEPILLADO PVD



**055**  
BRUSHED BLACK PVD  
NEGRO CEPILLADO PVD

**NEW**

**PVD** is an environmentally friendly technology through which stainless steel and titanium are linked at a molecular level to form a superficial metal alloy. Via electrolysis, the metal powder penetrates the previously treated materials' pores, becoming part of the object's composition itself, thus increasing its durability and providing much lighter coatings.

EL **PVD** es una tecnología respetuosa con el medio ambiente mediante el cual el acero inoxidable y el titanio se ligan a nivel molecular formando una aleación metálica superficial. A través de la electrólisis, el polvo de metales penetra en los poros de los materiales, previamente tratados, pasando a formar parte de la propia composición del objeto, aumentando la durabilidad y aportando recubrimientos mucho más ligeros.





## More versatile Más versátil

**Cosmic** is growing one of its most comprehensive collection, **Architect S+**, with more than 25 different accessories designed to offer optimal functionality, adding four new finishes to its range to allow it to fit in with any style of bathroom. The new offering stands out by including a wide selection of finishes in many of its parts, turning the **Architect S+** collection into a range that is a safe bet, superior, sustainable, decisive and now more versatile than ever. Because **Cosmic** is Innovation's Mind.

**Cosmic** hace crecer una de sus colecciones más completas, **Architect S+**, con más de 25 accesorios diferentes pensados para ofrecer la máxima funcionalidad, incorporando en su gama 4 nuevos acabados para poder encajar en cualquier estilo de baño. La nueva propuesta destaca por incorporar en muchas de las piezas una gran variedad de acabados, convirtiendo a la colección **Architect S+** en una colección segura, superior, sostenible, resolutive y ahora, más versátil que nunca. Porque **Cosmic** es *Innovation's Mind*.



**Architect S+** has successfully passed the high demanding tests of long last durability and resistance to extreme uses (static charge or impact testing) to assure long last durability of the product. All products come with 10 years warranty.

Toda la gama **Architect S+** ha superado con éxito exigentes tests de durabilidad y resistencia a usos extremos (cargas estáticas o test de impacto), para asegurar una larga vida al producto. Todos los artículos tienen 10 años de garantía

### Fixing disc (wall plate)

The fiberglass mix makes the fixing disc highly resistant. It adapts to the shape of the screw to remain completely fixed.

### Disco de fijación (wall plate)

La mezcla con fibra de vidrio hace que el disco de fijación sea muy resistente. Se adapta a la forma del tornillo, quedando completamente fijado.

### Two Allen carriage bolts

that are hidden and prevent extraction of the accessory.

### Dos tornillos ciegos allen

que quedan ocultos y privan la extracción del accesorio.

### Triple fixing

### Triple fijación

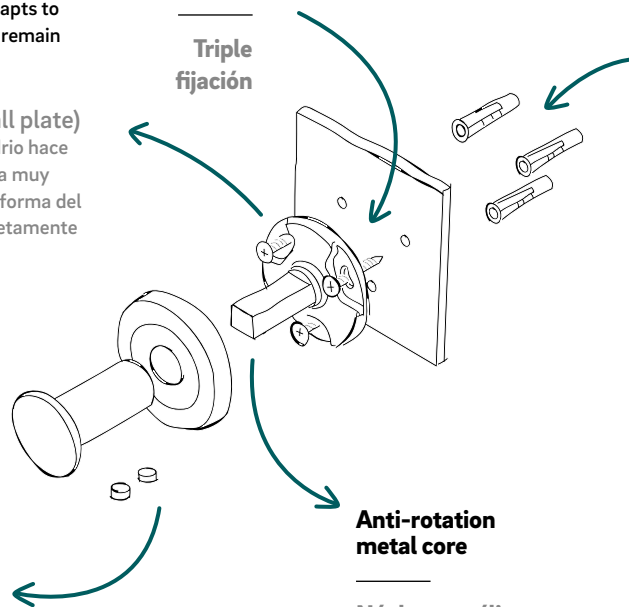

### Anti-rotation metal core

### Núcleo metálico antirrotación

### Fischer DuoPower wall plugs.

Strong and universal: anchoring with superior performance. This is the **first smart anchoring system** that decides whether to expand, fold or knit together depending on the wall's material.

### Tacos Fischer DuoPower:

Fuerte y Universal: el anclaje con un rendimiento superior. Es el **primer anclaje inteligente** que decide si se expande, se pliega o se anuda según el material de la pared.

### Fischer DuoPower



Installation video

Video de instalación

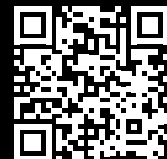

○  
HOOK X2  
PERCHA X2  
2,5X4,7X8,6 CM  
0,98X1,85X3,39 IN



WJC235A0023001  
CHROME / CROMO



WJC235A0023003  
MATTE STAINLESS STEEL / INOX MATE



WJC235A0023036  
MATTE BLACK / NEGRO MATE

⊙  
HOOK  
COLGADOR  
3,5X5X3,5 CM  
1,38X1,97X1,38 IN



WJC205A0021001 S  
CHROME / CROMO



WJC205A0021003  
BRUSHED STEEL / INOX CEPILLADO



WJC205A0021065  
MATT WHITE / BLANCO MATE



WJC205A0021040  
BRUSHED GOLD PVD / ORO CEPILLADO  
PVD



WJC205A0021054  
BRUSHED COPPER PVD / COBRE  
CEPILLADO PVD



WJC205A0021055  
BRUSHED BLACK PVD / NEGRO CEPILLADO  
PVD



WJC205A0021036  
MATTE BLACK / NEGRO MATE

⊙  
HOOK  
COLGADOR  
4X5,8X4 CM  
1,57X2,28X1,57 IN



DUAL SMARTFIX

**NEW** WJC205A1021001  
CHROME / CROMO



©  
**HOOK**  
COLGADOR  
5,5X6X5,5 CM  
2,17X2,36X2,17 IN



**WJC235A0021001** S  
CHROME / CROMO



**WJC235A0021003** S  
MATTE STAINLESS STEEL / INOX MATE



**WJC235A0021065**  
MATT WHITE / BLANCO MATE



**WJC235A0021040**  
BRUSHED GOLD PVD / ORO CEPILLADO PVD



**WJC235A0021054**  
BRUSHED COPPER PVD / COBRE CEPILLADO PVD



**WJC235A0021055**  
BRUSHED BLACK PVD / NEGRO CEPILLADO PVD



**WJC235A0021036** S  
MATTE BLACK / NEGRO MATE



⊙  
**FREE STANDING SOAP DISPENSER**  
DOSIFICADOR ENCIMERA  
6,2X8,1X18,3 CM  
2,44X3,19X7,2 IN

(240 ML)



**WJC205A0004001** S  
CHROME / CROMO



**WJC205A0004003**  
BRUSHED STEEL / INOX CEPILLADO



**WJC205A0004065**  
MATT WHITE / BLANCO MATE



**WJC205A0004040**  
BRUSHED GOLD PVD / ORO CEPILLADO PVD



**WJC205A0004054**  
BRUSHED COPPER PVD / COBRE CEPILLADO PVD



**WJC205A0004055**  
BRUSHED BLACK PVD / NEGRO CEPILLADO PVD



**WJC205A0004036**  
MATTE BLACK / NEGRO MATE

⊙△  
**WALL SOAP DISPENSER**  
DOSIFICADOR PARED  
10,2X11,6X13 CM  
4,02X4,57X5,12 IN

(400ML)



**WJC235A0003001**  
CHROME / CROMO



**WJC235A0003003**  
MATTE STAINLESS STEEL / INOX MATE



**WJC235A0003036**  
MATTE BLACK / NEGRO MATE

⊙  
**WALL SOAP DISPENSER**  
DOSIFICADOR PARED  
6,2X9,5X17,6 CM  
2,44X3,74X6,93 IN

DUAL SMARTFIX  
(240 ML)



**NEW** **WJC205A1003001** S  
CHROME / CROMO



**NEW** **WJC205A1003003**  
BRUSHED STEEL / INOX CEPILLADO



**NEW** **WJC205A1003065**  
MATT WHITE / BLANCO MATE



**NEW** **WJC205A1003040**  
BRUSHED GOLD PVD / ORO CEPILLADO PVD



**NEW** **WJC205A1003054**  
BRUSHED COPPER PVD / COBRE CEPILLADO PVD



**NEW** **WJC205A1003055**  
BRUSHED BLACK PVD / NEGRO CEPILLADO PVD



**NEW** **WJC205A1003036**  
MATTE BLACK / NEGRO MATE



○△  
FREE STANDING BRUSH  
HOLDER  
PORTACEPILLOS ENCIMERA  
6,2X6,2X13,5 CM  
2,44X2,44X5,31 IN



WJC205A0051001  
CHROME / CROMO



WJC226A0051003  
BRUSHED STEEL / INOX CEPILLADO



WJC205A0051065  
MATT WHITE / BLANCO MATE



WJC205A0051040  
BRUSHED GOLD PVD / ORO CEPILLADO  
PVD



WJC205A0051054  
BRUSHED COPPER PVD / COBRE  
CEPILLADO PVD



WJC205A0051055  
BRUSHED BLACK PVD / NEGRO CEPILLADO  
PVD



WJC226A0051036 **S**  
MATTE BLACK / NEGRO MATE



⊙△  
WALL TOOTHBRUSH HOLDER  
PORTACEPILLOS PARED

10,2X11,6X13 CM  
4,02X4,57X5,12 IN



WJC235A0053001  
CHROME / CROMO



WJC235A0053003  
MATTE STAINLESS STEEL / INOX MATE



WJC235A0053036  
MATTE BLACK / NEGRO MATE

○△  
WALL TOOTHBRUSH HOLDER  
PORTACEPILLOS PARED

6,2X8,7X13,4 CM  
2,44X3,43X5,28 IN

DUAL SMARTFIX



**NEW** WJC205A1053001  
CHROME / CROMO



**NEW** WJC205A1053003  
BRUSHED STEEL / INOX CEPILLADO



**NEW** WJC205A1053065  
MATT WHITE / BLANCO MATE



**NEW** WJC205A1053040  
BRUSHED GOLD PVD / ORO CEPILLADO  
PVD



**NEW** WJC205A1053054  
BRUSHED COPPER PVD / COBRE  
CEPILLADO PVD



**NEW** WJC205A1053055  
BRUSHED BLACK PVD / NEGRO CEPILLADO  
PVD



**NEW** WJC205A1053036  
BLACK-MATTE / NEGRO-MATE

⊙⊙○  
SHOWER SOAP DISH  
JABONERA DE DUCHA

35X11,5X8,5 CM  
13,78X4,53X3,35 IN



WJC235A0049001  
CHROME / CROMO



WJC235A0049003  
MATTE STAINLESS STEEL / INOX MATE



WJC235A0049065  
MATT WHITE / BLANCO MATE



WJC235A0049040  
BRUSHED GOLD PVD / ORO CEPILLADO  
PVD



WJC235A0049054  
BRUSHED COPPER PVD / COBRE  
CEPILLADO PVD



WJC235A0049055  
BRUSHED BLACK PVD / NEGRO CEPILLADO  
PVD



WJC235A0049036  
MATTE BLACK / NEGRO MATE



◎◎△  
SHOWER SOAP DISH WITH  
GLASS WIPER  
JABONERA DUCHA CON  
LIMPIACRISTALES  
35X11,5X8,5 CM  
13,78X4,53X3,35 IN



WJC235A0048001 **S**  
CHROME / CROMO



WJC235A0048003 **S**  
MATTE STAINLESS STEEL / INOX MATE



WJC235A0048065  
MATT WHITE / BLANCO MATE



WJC235A0048040  
BRUSHED GOLD PVD / ORO CEPILLADO  
PVD



WJC235A0048054  
BRUSHED COPPER PVD / COBRE  
CEPILLADO PVD



WJC235A0048055  
BRUSHED BLACK PVD / NEGRO CEPILLADO  
PVD



WJC235A0048036 **S**  
MATTE BLACK / NEGRO MATE



●●○△  
DOUBLE HANGING SHOWER  
SOAP DISH

DOBLE JABONERA DE DU-  
CHA COLGANTE

35,5X12X75,5 CM  
13,98X4,72X29,72 IN



WJC235A0047001  
CHROME / CROMO



WJC235A0047036  
MATTE BLACK / NEGRO MATE

○  
TISSUE BOX  
CAJA KLEENEX

25,8X9X12,7 CM  
10,16X3,54X5 IN



WJC235A0028002  
CHROME / CROMO



WJC235A0028003  
MATTE STAINLESS STEEL / INOX MATE



WJC235A0028036  
MATTE BLACK / NEGRO MATE

●△◇  
WALL MAGNIFYING MIRROR  
ESPEJO DE AUMENTO PARED

20X31X20 CM  
7,87X12,2X7,87 IN

(X5)



WJC235A0085001 S  
CHROME / CROMO



WJC235A0085003 S  
MATTE STAINLESS STEEL / INOX MATE



WJC235A0085065  
MATT WHITE / BLANCO MATE



WJC235A0085040  
BRUSHED GOLD PVD / ORO CEPILLADO  
PVD



WJC235A0085054  
BRUSHED COPPER PVD / COBRE  
CEPILLADO PVD



WJC235A0085055  
BRUSHED BLACK PVD / NEGRO CEPILLADO  
PVD



WJC235A0085036 S  
MATTE BLACK / NEGRO MATE

●●  
SHELF  
ESTANTE

40X9,6X2,6 CM  
15,75X3,78X1,02 IN



WJC235A0044001  
CHROME / CROMO



WJC235A0044003  
MATTE STAINLESS STEEL / INOX MATE



WJC235A0044036  
MATTE BLACK / NEGRO MATE



⊙ ⊙  
TOWEL RACK  
TOALLERO  
5.5X40X5.5 CM  
2.17X15.75X2.17 IN



WJC235A0069001 **S**  
CHROME / CROMO



WJC235A0069003 **S**  
MATTE STAINLESS STEEL / INOX MATE



WJC235A0069065  
MATT WHITE / BLANCO MATE



WJC235A0069040  
BRUSHED GOLD PVD / ORO CEPILLADO PVD



WJC235A0069054  
BRUSHED COPPER PVD / COBRE CEPILLADO PVD



WJC235A0069055  
BRUSHED BLACK PVD / NEGRO CEPILLADO PVD



WJC235A0069036 **S**  
MATTE BLACK / NEGRO MATE



ALTA DISPONIBILIDAD.  
HIGH AVAILABILITY.

☉  
TOWEL RACK  
TOALLERO

31,5X8,4X5,5 CM  
12,4X3,31X2,17 IN



WJC235A0063001   
CHROME / CROMO



WJC235A0063003   
MATTE STAINLESS STEEL / INOX MATE



WJC235A0063065  
MATT WHITE / BLANCO MATE



WJC235A0063040  
BRUSHED GOLD PVD / ORO CEPILLADO  
PVD



WJC235A0063054  
BRUSHED COPPER PVD / COBRE  
CEPILLADO PVD



WJC235A0063055  
BRUSHED BLACK PVD / NEGRO CEPILLADO  
PVD



WJC235A0063036   
MATTE BLACK / NEGRO MATE

☉  
TOWEL RACK  
TOALLERO

46,5X8,4X5,5 CM  
18,31X3,31X2,17 IN



WJC235A0064001   
CHROME / CROMO



WJC235A0064003   
MATTE STAINLESS STEEL / INOX MATE



WJC235A0064065  
MATT WHITE / BLANCO MATE



WJC235A0064040  
BRUSHED GOLD PVD / ORO CEPILLADO  
PVD



WJC235A0064054  
BRUSHED COPPER PVD / COBRE  
CEPILLADO PVD



WJC235A0064055  
BRUSHED BLACK PVD / NEGRO CEPILLADO  
PVD



WJC235A0064036   
MATTE BLACK / NEGRO MATE

☉  
TOWEL RACK  
TOALLERO

59X8,4X5,5 CM  
23,23X3,31X2,17 IN



WJC235A0065001  
CHROME / CROMO



WJC235A0065003  
MATTE STAINLESS STEEL / INOX MATE



WJC235A0065036  
MATTE BLACK / NEGRO MATE



⊙ ⊙  
DOUBLE TOWEL RACK  
TOALLERO DOBLE  
45,5X13,2X5,5 CM  
17,91X5,2X2,17 IN



WJC235A0061001  
CHROME / CROMO



WJC235A0061003  
MATTE STAINLESS STEEL / INOX MATE



WJC235A0061036  
MATTE BLACK / NEGRO MATE

⊙ ⊙  
DOUBLE TOWEL RACK  
TOALLERO DOBLE  
60X13,2X5,5 CM  
23,62X5,2X2,17 IN



WJC235A0060001  
CHROME / CROMO



WJC235A0060003  
MATTE STAINLESS STEEL / INOX MATE



WJC235A0060036  
MATTE BLACK / NEGRO MATE

⊙ ⊙  
SWIVEL TOWEL RACK  
TOALLERO GIRATORIO  
7,8X40,2X4,5 CM  
3,07X15,83X1,77 IN



WJC235A0075001  
CHROME / CROMO



WJC235A0075003  
MATTE STAINLESS STEEL / INOX MATE



WJC235A0075036  
MATTE BLACK / NEGRO MATE



ALTA DISPONIBILIDAD.  
HIGH AVAILABILITY.

◎◎  
TOWEL RING  
TOALLERO ARO  
23,6X8,4X16,3 CM  
9,29X3,31X6,42 IN



WJC235A0071001 **S**  
CHROME / CROMO



WJC235A0071003 **S**  
MATTE STAINLESS STEEL / INOX MATE



WJC235A0071065  
MATT WHITE / BLANCO MATE



WJC235A0071040  
BRUSHED GOLD PVD / ORO CEPILLADO  
PVD



WJC235A0071054  
BRUSHED COPPER PVD / COBRE  
CEPILLADO PVD



WJC235A0071055  
BRUSHED BLACK PVD / NEGRO CEPILLADO  
PVD



WJC235A0071036 **S**  
MATTE BLACK / NEGRO MATE

◎◎  
TOWEL RACK SHELF  
TOALLERO ESTANTE  
55X30,1X13,2 CM  
21,65X11,85X5,2 IN



WJC235A0068001 **S**  
CHROME / CROMO



WJC235A0068003  
MATTE STAINLESS STEEL / INOX MATE



WJC235A0068036 **S**  
MATTE BLACK / NEGRO MATE



○◎  
GRAB BAR  
ASA BAÑERA  
30X7X6 CM  
11,81X2,76X2,36 IN

(Ø 22MM)



WJC235A0024001 S  
CHROME / CROMO



WJC235A0024003  
MATTE STAINLESS STEEL / INOX MATE



WJC235A0024036 S  
MATTE BLACK / NEGRO MATE

○◎  
GRAB BAR  
ASA BAÑERA  
45X7X6 CM  
17,72X2,76X2,36 IN

(Ø 22MM)



WJC235A0025001  
CHROME / CROMO



WJC235A0025003  
MATTE STAINLESS STEEL / INOX MATE



WJC235A0025036  
MATTE BLACK / NEGRO MATE

○◎  
PAPER HOLDER WITH COVER  
PORTARROLLO CON TAPA  
15,8X11,8X9,2 CM  
6,22X4,65X3,62 IN



WJC235A0059001 S  
CHROME / CROMO

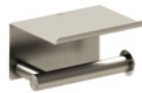

WJC235A0059003 S  
MATTE STAINLESS STEEL / INOX MATE



WJC235A0059065  
MATT WHITE / BLANCO MATE



WJC235A0059040  
BRUSHED GOLD PVD / ORO CEPILLADO PVD



WJC235A0059054  
BRUSHED COPPER PVD / COBRE CEPILLADO PVD



WJC235A0059055  
BRUSHED BLACK PVD / NEGRO CEPILLADO PVD



WJC235A0059036 S  
MATTE BLACK / NEGRO MATE



○◎  
PAPER HOLDER WITHOUT  
COVER

PORTARROLLO SIN TAPA

16,5X9X5,5 CM  
6,5X3,54X2,17 IN



WJC235A0058001   
CHROME / CROMO



WJC235A0058003   
MATTE STAINLESS STEEL / INOX MATE



WJC235A0058065  
MATT WHITE / BLANCO MATE



WJC235A0058040  
BRUSHED GOLD PVD / ORO CEPILLADO  
PVD



WJC235A0058054  
BRUSHED COPPER PVD / COBRE  
CEPILLADO PVD



WJC235A0058055  
BRUSHED BLACK PVD / NEGRO CEPILLADO  
PVD



WJC235A0058036   
MATTE BLACK / NEGRO MATE

○◎  
PAPER HOLDER WITHOUT  
COVER

PORTARROLLO SIN TAPA

15,5X7,3X10,8 CM  
6,1X2,87X4,25 IN



WJC235A0062001  
CHROME / CROMO



WJC235A0062003  
MATTE STAINLESS STEEL / INOX MATE



WJC235A0062036  
MATTE BLACK / NEGRO MATE

○◎  
DOUBLE PAPER HOLDER  
WITHOUT COVER

PORTARROLLO DOBLE SIN  
TAPA

24,5X9X5,5 CM  
9,65X3,54X2,17 IN



WJC235A0057001  
CHROME / CROMO



WJC235A0057003  
MATTE STAINLESS STEEL / INOX MATE



WJC235A0057036  
MATTE BLACK / NEGRO MATE

○◎  
VERTICAL PAPER HOLDER

PORTARROLLO VERTICAL

5,7X9,3X17,5 CM  
2,24X3,66X6,89 IN



WJC235A0096001  
CHROME / CROMO



WJC235A0096003  
MATTE STAINLESS STEEL / INOX MATE



WJC235A0096036  
MATTE BLACK / NEGRO MATE



⊙○△  
FREE STANDING TOILET  
BRUSH  
ESCOBILLERO SUELO  
9X9X38,7 CM  
3,54X3,54X15,24 IN



WJC235A0001001 **S**  
CHROME / CROMO



WJC235A0001003 **S**  
MATTE STAINLESS STEEL / INOX MATE



WJC235A0001065  
MATTE WHITE / BLANCO MATE



WJC235A0001040  
BRUSHED GOLD PVD / ORO CEPILLADO  
PVD



WJC235A0001054  
BRUSHED COPPER PVD / COBRE  
CEPILLADO PVD



WJC235A0001055  
BRUSHED BLACK PVD / NEGRO CEPILLADO  
PVD



WJC235A0001036 **S**  
MATTE BLACK / NEGRO MATE

⊙○△  
WALL TOILET BRUSH  
HOLDER  
ESCOBILLERO PARED  
9X11,5X38,7 CM  
3,54X4,53X15,24 IN



WJC235A0000001 **S**  
CHROME / CROMO



WJC235A0000003 **S**  
MATTE STAINLESS STEEL / INOX MATE



WJC235A0000065  
MATTE WHITE / BLANCO MATE



WJC235A0000040  
BRUSHED GOLD PVD / ORO CEPILLADO  
PVD



WJC235A0000054  
BRUSHED COPPER PVD / COBRE  
CEPILLADO PVD



WJC235A0000055  
BRUSHED BLACK PVD / NEGRO CEPILLADO  
PVD



WJC235A0000036 **S**  
MATTE BLACK / NEGRO MATE

⊙○△  
FREE STANDING TOILET  
BRUSH/PAPER HOLDER  
ESCOBILLERO/PORTARROLLO  
SUELO  
20X12X72,4 CM  
7,87X4,72X28,5 IN



WJC235A0097001  
CHROME / CROMO



WJC235A0097065  
MATT WHITE / BLANCO MATE



WJC235A0097040  
BRUSHED GOLD PVD / ORO CEPILLADO  
PVD



WJC235A0097036  
MATTE BLACK / NEGRO MATE



S ALTA DISPONIBILIDAD.  
HIGH AVAILABILITY.

○△  
WASTE BIN  
PAPELERA  
20,5X20,5X26 CM  
8,07X8,07X10,24 IN



WJC235A0002001  
CHROME / CROMO



WJC235A0002003  
MATTE STAINLESS STEEL / INOX MATE



WJC277A0002036  
MATTE BLACK / NEGRO MATE

(5L)

○△  
WASTE BIN  
PAPELERA  
17,2X23,8X26,8 CM  
6,77X9,37X10,55 IN



WJC292A0002036  
MATTE BLACK / NEGRO MATE

(3L)



# Bath Life

Design by **Carles Ferruz**





# Bath Life

Design by Carles Ferruz

AxBxC CM  
INCH AxBxC



**Bath Life** has successfully passed the high demanding tests of long last durability and resistance to extreme uses (static charge or impact testing) to assure long last durability of the product.

Toda la gama **Bath Life** ha superado con éxito exigentes tests de durabilidad y resistencia a usos extremos (cargas estáticas o test de impacto), para asegurar una larga vida al producto.



## FEATURES / CARACTERÍSTICAS

Easy installation: double pitch screw.  
Hidden attachments. Anti-corrosion.

Fácil instalación: tornillo de doble paso.  
Fijaciones ocultas. Anticorrosión.

## FINISHES / ACABADOS

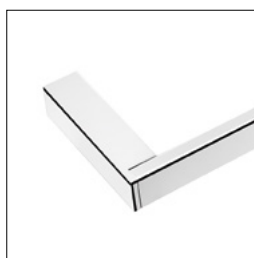

**001**  
Chrome  
Cromo



# Accessories | Accesorios

⊙  
**HOOK**  
COLGADOR  
2,4X5,5X3,6 CM  
0,94X2,17X1,42 IN



**WJP049A3001001**  
CHROME / CROMO

⊙  
**HOOK**  
COLGADOR  
2X2X7 CM  
0,79X0,79X2,76 IN



**WJC229A0021001**  
CHROME / CROMO

⊙  
**FREE STANDING SOAP DISPENSER**  
DOSIFICADOR ENCIMERA  
8X8,5X15 CM  
3,15X3,35X5,91 IN  
(275 ML)



**WJC229A0004001**  
CHROME / CROMO

⊙  
**WALL SOAP DISPENSER**  
DOSIFICADOR PARED  
8X10,5X15 CM  
3,15X4,13X5,91 IN  
(275ML)



**WJC229A0005001**  
CHROME / CROMO

⊙△  
**FREE STANDING BRUSH HOLDER**  
PORTACEPILLOS ENCIMERA  
8X5X12,5 CM  
3,15X1,97X4,92 IN



**WJC229A0051001**  
CHROME / CROMO

⊙△  
**WALL TOOTHBRUSH HOLDER**  
PORTACEPILLOS PARED  
8X7,5X12,5 CM  
3,15X2,95X4,92 IN



**WJC229A0052001**  
CHROME / CROMO

⊙  
**TOWEL RACK**  
TOALLERO  
30X8,5X2 CM  
11,81X3,35X0,79 IN



**WJC229A0063001**  
CHROME / CROMO

⊙  
**TOWEL RACK**  
TOALLERO  
45X8,5X2 CM  
17,72X3,35X0,79 IN



**WJC229A0069001**  
CHROME / CROMO

⊙  
**TOWEL RACK**  
TOALLERO  
60X8,5X2 CM  
23,62X3,35X0,79 IN



**WJC229A0064001**  
CHROME / CROMO

⊙  
**SWIVEL DOUBLE TOWEL RACK**  
TOALLERO DOBLE GIRATORIO  
2,8X3,6X7,5 CM  
1,1X1,4,17X2,95 IN



**WJP049A1401001**  
CHROME / CROMO



# Bath Life

Design by Carles Ferruz

AxBxC CM  
INCH AxBxC





**TOWEL RING**  
TOALLERO ARO

**23X3X11,5 CM**  
9,06X1,18X4,53 IN



**WJC229A0071001**  
CHROME / CROMO



**TOWEL RACK SHELF**  
TOALLERO ESTANTE

**60X30X9,5 CM**  
23,62X11,81X3,74 IN



**WJC229A0068001**  
CHROME / CROMO



**PAPER HOLDER WITH COVER**  
PORTARROLLO CON TAPA

**16X12X6 CM**  
6,3X4,72X2,36 IN



**WJC229A0056001**  
CHROME / CROMO



**PAPER HOLDER WITHOUT COVER**  
PORTARROLLO SIN TAPA

**16X8X2 CM**  
6,3X3,15X0,79 IN



**WJC229A0062001**  
CHROME / CROMO



**FREE STANDING TOILET BRUSH**  
ESCOBILLERO SUELO

**10X8X46 CM**  
3,94X3,15X18,11 IN



**WJC253A0001001**  
CHROME / CROMO



**WALL TOILET BRUSH HOLDER**  
ESCOBILLERO PARED

**10X9X46 CM**  
3,94X3,54X18,11 IN



**WJC253A0000001**  
CHROME / CROMO



# Black & White

Design by **Cosmic Studio**





# Black & White

Design by Cosmic Studio





**Black & White** has successfully passed the high demanding tests of long last durability and resistance to extreme uses (static charge or impact testing) to assure long last durability of the product.

Toda la gama **Black & White** ha superado con éxito exigentes tests de durabilidad y resistencia a usos extremos (cargas estáticas o test de impacto), para asegurar una larga vida al producto.



#### FEATURES / CARACTERÍSTICAS

Easy installation: double pitch screw.  
Hidden attachments. Anti-corrosion.  
Lead free paint.

Fácil instalación: tornillo de doble paso.  
Fijaciones ocultas. Anticorrosión.  
Pintura libre de plomo.

#### FINISHES / ACABADOS

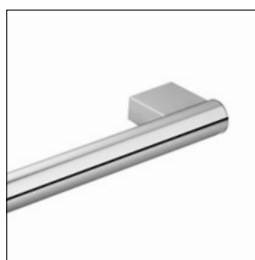

**001**  
Chrome  
Cromo



**065**  
Matte white  
Blanco mate

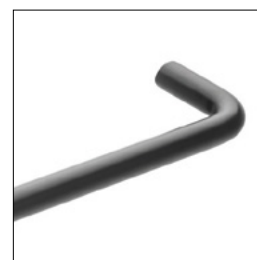

**036**  
Matte black  
Negro mate



# Black & White

Design by **Cosmic Studio**



⊙  
**GLOVE HOOK**  
PORTAGUANTES  
2,5X3,5X2,5 CM  
0,98X1,38X0,98 IN



**WJC238A0020065**  
MATTE WHITE / BLANCO MATE



**WJC238A0020036**  
MATTE BLACK / NEGRO MATE

⊙  
**HOOK**  
COLGADOR  
2X3,5X7 CM  
0,79X1,38X2,76 IN



**WJC251A0021001**  
CHROME / CROMO

⊙  
**HOOK**  
COLGADOR  
5X3X5 CM  
1,97X1,18X1,97 IN



**WJC205A0121001**  
CHROME / CROMO



**WJC238A0021065**  
MATTE WHITE / BLANCO MATE



**WJC238A0021036**  
MATTE BLACK / NEGRO MATE

⊙  
**FREE STANDING SOAP DISPENSER**  
DOSIFICADOR ENCIMERA  
6,2X8,3X16,7 CM  
2,44X3,27X6,57 IN



**WJC251A0004001**  
CHROME / CROMO



**WJC238A0004065**  
MATTE WHITE / BLANCO MATE



**WJC238A0004036**  
MATTE BLACK / NEGRO MATE

⊙  
**WALL SOAP DISPENSER**  
DOSIFICADOR PARED  
6,2X8,7X16,5 CM  
2,44X3,43X6,5 IN



**WJC251A0005001**  
CHROME / CROMO



**WJC238A0005065**  
MATTE WHITE / BLANCO MATE



**WJC238A0005036**  
MATTE BLACK / NEGRO MATE



⊕△  
FREE STANDING BRUSH  
HOLDER  
PORTACEPILLOS ENCIMERA  
6,2X6,2X14 CM  
2,44X2,44X5,51 IN



WJC251A0053001  
CHROME / CROMO



WJC238A0053065  
MATTE WHITE / BLANCO MATE



WJC238A0053036  
MATTE BLACK / NEGRO MATE

⊕△  
WALL TOOTHBRUSH HOLDER  
PORTACEPILLOS PARED  
8,7X6,2X14 CM  
3,43X2,44X5,51 IN



WJC251A0054001  
CHROME / CROMO



WJC238A0054065  
MATTE WHITE / BLANCO MATE



WJC238A0054036  
MATTE BLACK / NEGRO MATE



# Black & White

Design by **Cosmic Studio**



**FREE STANDING SOAP DISH**  
JABONERA ENCIMERA

11,5X11,5X1 CM  
4,53X4,53X0,39 IN



**WJC251A0034001**  
CHROME / CROMO



**WALL SOAP DISH**  
JABONERA PARED

11,5X14X4,5 CM  
4,53X5,51X1,77 IN



**WJC251A0032001**  
CHROME / CROMO



**SHOWER SOAP DISH**  
JABONERA DE DUCHA

30X12X4 CM  
11,81X4,72X1,57 IN



**WJC251A0049051**  
CHROME-WHITE / CROMO-BLANCO



**WJC238A0049065**  
MATTE WHITE / BLANCO MATE



**WJC251A0049061**  
CHROME-BLACK / CROMO-NEGRO



**WJC238A0049036**  
MATTE BLACK / NEGRO MATE



**WALL MAGNIFYING MIRROR**  
ESPEJO DE AUMENTO PARED

20X31X20 CM  
7,87X12,2X7,87 IN



**WJC238A0085065**  
MATTE WHITE / BLANCO MATE



**WJC238A0085036**  
MATTE BLACK / NEGRO MATE

(x3)



**FREE STANDING MAGNIFYING MIRROR**  
ESPEJO AUMENTO ENCIMERA

20X16,3X33,3 CM  
7,87X6,42X13,11 IN



**WJC238A0083065**  
MATTE WHITE / BLANCO MATE



**WJC238A0083036**  
MATTE BLACK / NEGRO MATE

(x3)



⊙  
TOWEL RACK  
TOALLERO  
40X7,5X2 CM  
15,75X2,95X0,79 IN



WJC238A0064065  
MATTE WHITE / BLANCO MATE



WJC238A0064036  
MATTE BLACK / NEGRO MATE

⊙  
TOWEL RACK  
TOALLERO  
60X7,5X2 CM  
23,62X2,95X0,79 IN



WJC238A0065065  
MATTE WHITE / BLANCO MATE



WJC238A0065036  
MATTE BLACK / NEGRO MATE

⊙  
TOWEL RACK  
TOALLERO  
23,5X8X2,5 CM  
9,25X3,15X0,98 IN



WJC251A0062001  
CHROME / CROMO

⊙  
TOWEL RACK  
TOALLERO  
40X8X2,5 CM  
15,75X3,15X0,98 IN



WJC251A0064001  
CHROME / CROMO

⊙  
TOWEL RACK  
TOALLERO  
60X8X2,5 CM  
23,62X3,15X0,98 IN



WJC251A0065001  
CHROME / CROMO



# Black & White

Design by **Cosmic Studio**



## SWIVEL DOUBLE TOWEL RACK

TOALLERO DOBLE GIRATORIO

41X5,5X7,5 CM  
16,14X2,17X2,95 IN



WJC251A0075001  
CHROME / CROMO



WJC238A0075065  
MATTE WHITE / BLANCO MATE



WJC238A0075036  
MATTE BLACK / NEGRO MATE

## TOWEL RING

TOALLERO ARO

20X5X15 CM  
7,87X1,97X5,91 IN



WJC251A0071001  
CHROME / CROMO



WJC238A0071065  
MATTE WHITE / BLANCO MATE



WJC238A0071036  
MATTE BLACK / NEGRO MATE

## TOWEL RACK SHELF

TOALLERO ESTANTE

60X25X11 CM  
23,62X9,84X4,33 IN



WJC251A0068001  
CHROME / CROMO



WJC238A0068065  
MATTE WHITE / BLANCO MATE



WJC238A0068036  
MATTE BLACK / NEGRO MATE

## GRAB BAR

ASA BAÑERA

40X7X3 CM  
15,75X2,76X1,18 IN



WJC251A0024001  
CHROME / CROMO

## GRAB BAR

ASA BAÑERA

60X7X3 CM  
23,62X2,76X1,18 IN



WJC251A0025001  
CHROME / CROMO



⊙  
GRAB BAR  
ASA BAÑERA  
80X7X3 CM  
31,5X2,76X1,18 IN



WJC251A0098001  
CHROME / CROMO

⊙  
GRAB BAR  
ASA BAÑERA  
100X7X3 CM  
39,37X2,76X1,18 IN



WJC251A0099001  
CHROME / CROMO



⊙△  
PAPER HOLDER WITH COVER  
PORTARROLLO CON TAPA  
13X11,5X11,5 CM  
5,12X4,53X4,53 IN



WJC238A0059065  
MATTE WHITE / BLANCO MATE



WJC238A0059036  
MATTE BLACK / NEGRO MATE

⊙△  
PAPER HOLDER WITH COVER  
PORTARROLLO CON TAPA  
14,5X13X8 CM  
5,71X5,12X3,15 IN



WJC251A0059001  
CHROME / CROMO

⊙  
PAPER HOLDER WITHOUT COVER  
PORTARROLLO SIN TAPA  
4X12,5X4 CM  
1,57X4,92X1,57 IN



WJC238A0058065  
MATTE WHITE / BLANCO MATE



WJC238A0058036  
MATTE BLACK / NEGRO MATE



# Black & White

Design by **Cosmic Studio**



⊙  
PAPER HOLDER WITHOUT COVER  
PORTARROLLO SIN TAPA  
17X8,5X2,5 CM  
6,69X3,35X0,98 IN



WJC251A0058001  
CHROME / CROMO



WJC238A0158065  
MATTE WHITE / BLANCO MATE



WJC238A0158036  
MATTE BLACK / NEGRO MATE

⊙○△  
FREE STANDING TOILET BRUSH  
ESCOBILLERO SUELO  
9X9X38,7 CM  
3,54X3,54X15,24 IN



WJC235A0001001 S  
CHROME / CROMO



WJC235A0001065  
MATTE WHITE / BLANCO MATE



WJC235A0001036 S  
MATTE BLACK / NEGRO MATE

⊙○△  
WALL TOILET BRUSH HOLDER  
ESCOBILLERO PARED  
9X11,5X38,7 CM  
3,54X4,53X15,24 IN



WJC235A0000001 S  
CHROME / CROMO



WJC235A0000065  
MATTE WHITE / BLANCO MATE



WJC235A0000036 S  
MATTE BLACK / NEGRO MATE

⊙○△  
FREE-STANDING OR WALL TOILET BRUSH  
ESCOBILLERO SUELO/PARED  
9X10X43 CM  
3,54X3,94X16,93 IN  
DUAL SMARTFIX



WJC251A0000001  
CHROME / CROMO



WJC238A0000065  
MATTE WHITE / BLANCO MATE



WJC238A0000036  
MATTE BLACK / NEGRO MATE

⊙○  
FREE STANDING TOILET BRUSH/PAPER HOLDER  
ESCOBILLERO/PORTARROLLO SUELO  
27,5X20X65 CM  
10,83X7,87X25,59 IN



WJC251A0097001  
CHROME / CROMO





# Diabolo

Design by Yang Ripol





# Diabolo

Design by Yang Ripol



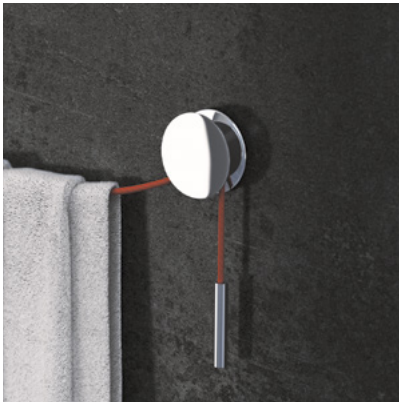

**QUICK FIX / QUICK FIX**

Our updated Diabolo collection now includes a dual installation system for installing bathroom accessories with or without a drill. Quick Fix adhesive, designed exclusively for our firm, means that bathroom accessories can be installed without drilling holes in the wall.

La colección Diabolo presenta como novedad el sistema de instalación dual, que permite sujetar los accesorios de baño con y sin taladros. Con el adhesivo Quick Fix, elaborado en exclusiva para la firma, se facilita el montaje sin la necesidad de hacer agujeros en la pared.

**FEATURES / CARACTERÍSTICAS**

Easy installation: double pitch screw. Hidden attachments. Anti-corrosion.

Fácil instalación: tornillo de doble paso. Fijaciones ocultas. Anticorrosión.

**Diabolo** has successfully passed the high demanding tests of long last durability and resistance to extreme uses (static charge or impact testing) to assure long last durability of the product. All products come with 10 years warranty.

Toda la gama **Diabolo** ha superado con éxito exigentes tests de durabilidad y resistencia a usos extremos (cargas estáticas o test de impacto), para asegurar una larga vida al producto. Todos los artículos tienen 10 años de garantía.



Easy installation without drilling

Fácil instalación sin taladro



Bonded with high adhesion adhesive (3M)

Fijación con adhesivo de alta adherencia (3M)



Quick, easy, silent installation

Montaje sin ruido, fácil y rápido



Static load of 5 kg

Carga estática de 5 KG



Do not use on painted surfaces and gypsum walls

No usar en superficies pintadas ni en paredes rugosas

**QUICK  
FIX**

**FINISHES / ACABADOS**



**001**  
Chrome  
Cromo



**065**  
White  
Blanco

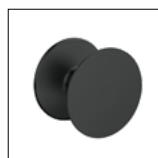

**036**  
Black  
Negro

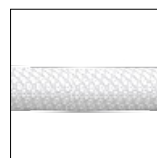

White  
Blanco

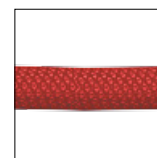

Red  
Rojo



Black  
Negro





**HOOK**  
COLGADOR  
5X3,7X5 CM  
1,97X1,46X1,97 IN

DUAL QUICKFIX



WJB275A0021001  
CHROME / CROMO



WJB275A0021065  
MATTE WHITE / BLANCO MATE



WJB275A0021036  
MATTE BLACK / NEGRO MATE



**TOWEL RACK**  
TOALLERO  
45X1,6X5 CM  
17,72X0,63X1,97 IN

DUAL QUICKFIX



WJB275A1064001  
CHROME-WHITE / CROMO-BLANCO

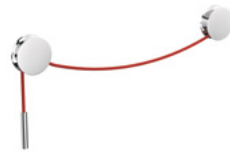

WJB275A2064001  
CHROME-RED / CROMO-ROJO



WJB275A0064001  
CHROME-BLACK / CROMO-NEGRO



**PAPER HOLDER WITHOUT COVER**  
PORTARROLLO SIN TAPA  
5X1,6X5 CM  
1,97X0,63X1,97 IN

DUAL QUICKFIX



WJB275A1058001  
CHROME-WHITE / CROMO-BLANCO



WJB275A2058001  
CHROME-RED / CROMO-ROJO



WJB275A0058001  
CHROME-BLACK / CROMO-NEGRO

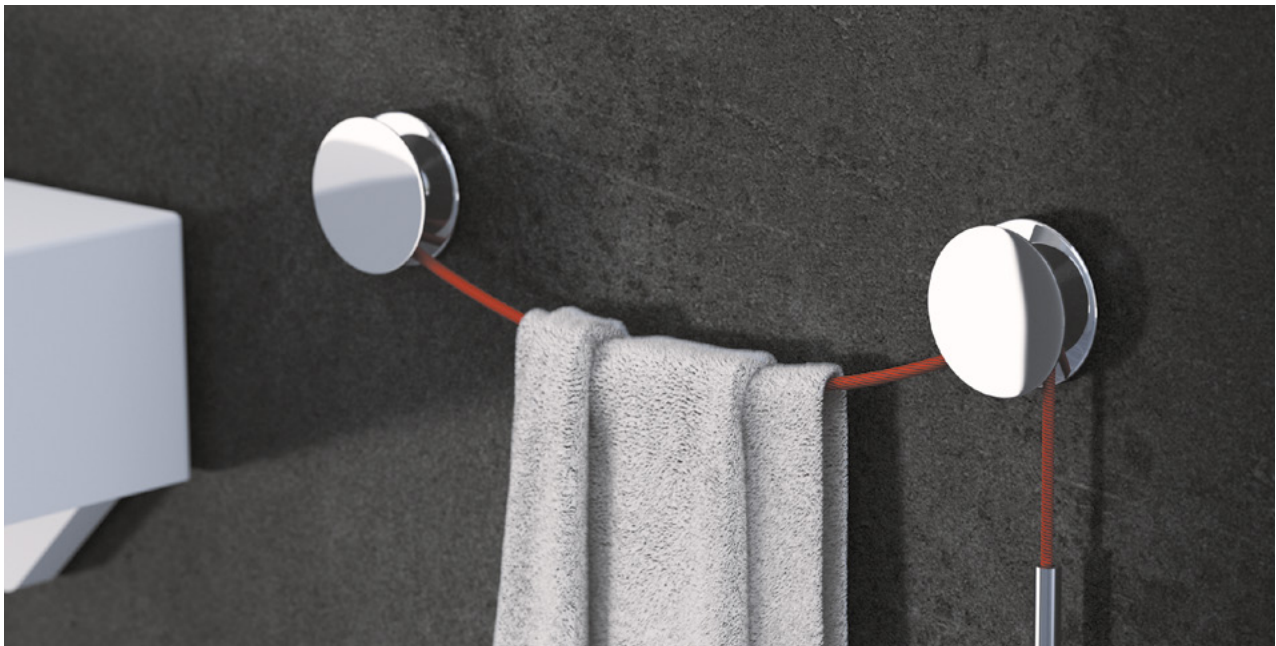



# Duo

Design by Raúl Ruiz





# Duo

Design by Raúl Ruiz





**QUICK FIX / QUICK FIX**

Our Duo collection includes a installation system for installing bathroom accessories without a drill. Quick Fix adhesive, designed exclusively for our firm, means that bathroom accessories can be installed without drilling holes in the wall.

La colección Duo presenta como novedad el sistema de instalación Quick Fix, que permite sujetar los accesorios de baño sin taladros. Con el adhesivo Quick Fix, elaborado en exclusiva para la firma, se facilita el montaje sin la necesidad de hacer agujeros en la pared.

**FEATURES / CARACTERÍSTICAS**

Easy installation.  
Anti-corrosion.

Fácil instalación.  
Anticorrosión.

**Duo** has successfully passed the high demanding tests of long last durability and resistance to extreme uses (static charge or impact testing) to assure long last durability of the product. All products come with 10 years warranty.

Toda la gama **Duo** ha superado con éxito exigentes tests de durabilidad y resistencia a usos extremos (cargas estáticas o test de impacto), para asegurar una larga vida al producto. Todos los artículos tienen 10 años de garantía.



Easy installation  
without drilling

Fácil instalación  
sin taladro



Bonded with  
high adhesion  
adhesive

Fijación con  
adhesivo de alta  
adherencia



Quick, easy, silent  
installation

Montaje sin ruido,  
fácil y rápido



Static load  
of 5 kg

Carga estática  
de 5 KG



Do not use on  
painted surfaces  
and gypsum walls

No usar en  
superficies pintadas  
ni en paredes rugosas

**QUICK  
FIX**

**FINISHES / ACABADOS**



Duo  
Round



Duo  
Square



# Duo Round

Design by Raúl Ruiz



**HOOK**  
COLGADOR  
5,5X5X5,5 CM  
2,17X1,97X2,17 IN

QUICKFIX



**WJB262A0021001**  
CHROME / CROMO



**WALL SOAP DISPENSER**  
DOSIFICADOR PARED  
7,5X12X16 CM  
2,95X4,72X6,3 IN

QUICKFIX  
(200ML)



**WJB262A0005001**  
CHROME / CROMO



**WALL TOOTHBRUSH HOLDER**  
PORTACEPILLOS PARED  
7,5X11X12 CM  
2,95X4,33X4,72 IN

QUICKFIX



**WJB262A0052001**  
CHROME / CROMO



**SHOWER SOAP DISH**  
JABONERA DE DUCHA  
15X11X5,5 CM  
5,91X4,33X2,17 IN

QUICKFIX



**WJB262A0049001**  
CHROME / CROMO



**SHOWER SOAP DISH**  
JABONERA DE DUCHA  
30X13X13 CM  
11,81X5,12X5,12 IN

QUICKFIX



**WJB262A0042001**  
CHROME / CROMO



**CORNER SHOWER BASKET**  
JABONERA DE DUCHA RINCÓN  
25X25,6X13 CM  
9,84X10,08X5,12 IN

QUICKFIX



**WJB262A0041001**  
CHROME / CROMO



**GLASS SHELF**  
ESTANTE VIDRIO  
40X10,5X5,5 CM  
15,75X4,13X2,17 IN

QUICKFIX



**WJB262A0044001**  
CHROME / CROMO



**GLASS SHELF**  
ESTANTE VIDRIO  
60X10,5X5,5 CM  
23,62X4,13X2,17 IN

QUICKFIX



**WJB262A0045001**  
CHROME / CROMO



**TOWEL RACK**  
TOALLERO  
30,5X7X5,5 CM  
12,01X2,76X2,17 IN

QUICKFIX



**WJB262A0063001**  
CHROME / CROMO



**TOWEL RACK**  
TOALLERO  
45,5X7X5,5 CM  
17,91X2,76X2,17 IN

QUICKFIX



**WJB262A0064001**  
CHROME / CROMO



○◎  
TOWEL RACK  
TOALLERO

60,5X7X5,5 CM  
23,82X2,76X2,17 IN

QUICKFIX



WJB262A0065001  
CHROME / CROMO

○◎  
TOWEL RING  
TOALLERO ARO

20X5X22 CM  
7,87X1,97X8,66 IN

QUICKFIX



WJB262A0072001  
CHROME / CROMO

○◎  
TOWEL RACK SHELF  
TOALLERO ESTANTE

61X20X5,5 CM  
24,02X7,87X2,17 IN

QUICKFIX



WJB262A0068001  
CHROME / CROMO

○◎  
PAPER HOLDER WITH COVER  
PORTARROLLO CON TAPA

12,5X5X13 CM  
4,92X1,97X5,12 IN

QUICKFIX



WJB262A0059001  
CHROME / CROMO

○◎  
RIGHT PAPER HOLDER WITHOUT  
COVER  
PORTARROLLO SIN TAPA DERECHO

17X7,5X5,5 CM  
6,69X2,95X2,17 IN

QUICKFIX



WJB262A0056001  
CHROME / CROMO

○◎  
LEFT PAPER HOLDER WITHOUT  
COVER  
PORTARROLLO SIN TAPA IZQUIER-  
DO

17X7,5X5,5 CM  
6,69X2,95X2,17 IN

QUICKFIX



WJB262A0057001  
CHROME / CROMO

○◎◇  
WALL TOILET BRUSH HOLDER  
ESCOBILLERO PARED

7,5X11X38 CM  
2,95X4,33X14,96 IN

QUICKFIX



WJB262A0000001  
CHROME / CROMO

○◎◇  
WALL TOILET BRUSH HOLDER  
ESCOBILLERO PARED

9X11X41,5 CM  
3,54X4,33X16,34 IN

QUICKFIX



WJB262A0001001  
CHROME / CROMO



# Duo Round

Design by Raúl Ruiz





Make better use of your space;  
put an accessory wherever you need it.

Aprovecha mejor tu espacio,  
coloca un accesorio allí donde lo necesites.



# Duo Square

Design by Raúl Ruiz

AxBxC CM  
INCH AxBxC



**HOOK**  
COLGADOR  
5X5X5 CM  
1,97X1,97X1,97 IN



QUICKFIX

**WJB264A0021001**  
CHROME / CROMO



**WALL SOAP DISPENSER**  
DOSIFICADOR PARED  
7,5X12X16 CM  
2,95X4,72X6,3 IN



QUICKFIX  
(200ML)

**WJB264A0005001**  
CHROME / CROMO



**WALL TOOTHBRUSH HOLDER**  
PORTACEPILLOS PARED  
7,5X11X12 CM  
2,95X4,33X4,72 IN



QUICKFIX

**WJB264A0052001**  
CHROME / CROMO



**SHOWER SOAP DISH**  
JABONERA DE DUCHA  
15X11X5 CM  
5,91X4,33X1,97 IN



QUICKFIX

**WJB264A0049001**  
CHROME / CROMO



**SHOWER SOAP DISH**  
JABONERA DE DUCHA  
30X13X13 CM  
11,81X5,12X5,12 IN



QUICKFIX

**WJB264A0042001**  
CHROME / CROMO



**CORNER SHOWER BASKET**  
JABONERA DE DUCHA RINCÓN  
26X26X13 CM  
10,24X10,24X5,12 IN



QUICKFIX

**WJB264A0041001**  
CHROME / CROMO



**GLASS SHELF**  
ESTANTE VIDRIO  
40X10,5X5,5 CM  
15,75X4,13X2,17 IN



QUICKFIX

**WJB264A0044001**  
CHROME / CROMO



**GLASS SHELF**  
ESTANTE VIDRIO  
60X10,5X5,5 CM  
23,62X4,13X2,17 IN



QUICKFIX

**WJB264A0045001**  
CHROME / CROMO



**TOWEL RACK**  
TOALLERO  
30,5X7X5 CM  
12,01X2,76X1,97 IN



QUICKFIX

**WJB264A0063001**  
CHROME / CROMO



**TOWEL RACK**  
TOALLERO  
45,5X7X5 CM  
17,91X2,76X1,97 IN



QUICKFIX

**WJB264A0064001**  
CHROME / CROMO



○◎  
TOWEL RACK  
TOALLERO

60,5X7X5 CM  
23,82X2,76X1,97 IN

QUICKFIX



WJB264A0065001  
CHROME / CROMO

○◎  
TOWEL RING  
TOALLERO ARO

20X5X22 CM  
7,87X1,97X8,66 IN

QUICKFIX



WJB264A0072001  
CHROME / CROMO

○◎  
TOWEL RACK SHELF  
TOALLERO ESTANTE

60,5X19,5X5 CM  
23,82X7,68X1,97 IN

QUICKFIX



WJB264A0068001  
CHROME / CROMO

○◎  
PAPER HOLDER WITH COVER  
PORTARROLLO CON TAPA

12,5X5X13 CM  
4,92X1,97X5,12 IN

QUICKFIX



WJB264A0059001  
CHROME / CROMO

○◎  
RIGHT PAPER HOLDER WITHOUT  
COVER  
PORTARROLLO SIN TAPA DERECHO

17X7,5X5 CM  
6,69X2,95X1,97 IN

QUICKFIX



WJB264A0056001  
CHROME / CROMO

○◎  
LEFT PAPER HOLDER WITHOUT  
COVER  
PORTARROLLO SIN TAPA IZQUIER-  
DO

17X7,5X5 CM  
6,69X2,95X1,97 IN

QUICKFIX



WJB264A0057001  
CHROME / CROMO

○◎◇  
WALL TOILET BRUSH HOLDER  
ESCOBILLERO PARED

7,5X11X38 CM  
2,95X4,33X14,96 IN

QUICKFIX



WJB264A0000001  
CHROME / CROMO

○◎◇  
WALL TOILET BRUSH HOLDER  
ESCOBILLERO PARED

9X11X41,5 CM  
3,54X4,33X16,34 IN

QUICKFIX



WJB264A0001001  
CHROME / CROMO



# Duo Square

Design by Raúl Ruiz



Forget about drilling walls;  
get the most out of them.

Olvídate de agujerear las paredes,  
sácales el máximo partido.





# Eda

Design by **Lázaro Rosa-Violán**







# 3

YEARS GUARANTEE  
AÑOS GARANTÍA

**BAMBOO**

# 10

YEARS GUARANTEE  
AÑOS GARANTÍA

**CHROME / BLACK**



**Eda** has successfully passed the high demanding tests of long last durability and resistance to extreme uses (static charge or impact testing) to assure long last durability of the product.

Toda la gama **Eda** ha superado con éxito exigentes tests de durabilidad y resistencia a usos extremos (cargas estáticas o test de impacto), para asegurar una larga vida al producto.

#### FEATURES / CARACTERÍSTICAS

Easy installation: double pitch screw.  
Hidden attachments.

Fácil instalación: tornillo de doble paso.  
Fijaciones ocultas.

#### FINISHES / ACABADOS



**001**  
Chrome  
Cromo



**036**  
Matte Black  
Negro Mate



**000**  
Natural  
Bamboo  
Bambú  
Natural



**036**  
Black  
Bamboo  
Bambú  
Negro



**001**  
Natural  
Bamboo-  
Chrome  
Bambú  
Natural-  
Cromo



**603**  
Natural  
Bamboo-  
Matte Black  
Bambú  
Natural-Negro  
Mate



⊙  
**HOOK**  
COLGADOR  
2,3X6X2,3 CM  
0,91X2,36X0,91 IN



WJP056A3011001  
CHROME / CROMO



WJP056A3011036  
MATTE BLACK / NEGRO MATE

⊙  
**FREE STANDING SOAP DISPENSER**  
DOSIFICADOR ENCIMERA  
6,3X9,8X20,4 CM  
2,48X3,86X8,03 IN



WJP056A7831001  
CHROME / CROMO



WJP056A7831036  
MATTE BLACK / NEGRO MATE

(185ML)

⊙  
**FREE STANDING BRUSH HOLDER**  
PORTACEPILLOS ENCIMERA  
6,3X6,3X17,5 CM  
2,48X2,48X6,89 IN



WJP056A7050001  
CHROME / CROMO



WJP056A7050036  
MATTE BLACK / NEGRO MATE

☐⊙  
**SHOWER SOAP DISH**  
JABONERA DE DUCHA  
24,3X11,3X4,8 CM  
9,57X4,45X1,89 IN



WJP056A6020001  
NATURAL BAMBOO-CHROME / BAMBU NATURAL-CROMO



WJP056A6020603  
NATURAL BAMBOO-MATTE BLACK / BAMBU NATURAL-NEGRO MATE

☐  
**TRAY**  
BANDEJA  
24,3X11,3X1,6 CM  
9,57X4,45X0,63 IN



WJP056A9701000  
NATURAL BAMBOO / BAMBU NATURAL



WJP056A9701036  
BLACK BAMBOO / BAMBU NEGRO

☐⊙  
**TISSUE BOX**  
CAJA KLEENEX  
26X14,5X7,6 CM  
10,24X5,71X2,99 IN



WJP056A9401001  
NATURAL BAMBOO-CHROME / BAMBU NATURAL-CROMO



WJP056A9401603  
NATURAL BAMBOO-MATTE BLACK / BAMBU NATURAL-NEGRO MATE

⊙⊙  
**TOWEL RACK**  
TOALLERO  
30X9X5,5 CM  
11,81X3,54X2,17 IN



WJP056A1030001  
CHROME / CROMO



WJP056A1030036  
MATTE BLACK / NEGRO MATE

⊙⊙  
**TOWEL RACK**  
TOALLERO  
45X9X5,5 CM  
17,72X3,54X2,17 IN



WJP056A1045001  
CHROME / CROMO



WJP056A1045036  
MATTE BLACK / NEGRO MATE

⊙⊙  
**TOWEL RING**  
TOALLERO ARO  
23X9X23,5 CM  
9,06X3,54X9,25 IN



WJP056A2005001  
CHROME / CROMO



WJP056A2005036  
MATTE BLACK / NEGRO MATE

⊙⊙  
**PAPER HOLDER WITH COVER**  
PORTARROLLO CON TAPA  
17,7X10X8 CM  
6,97X3,94X3,15 IN



WJP056A4002001  
CHROME / CROMO



WJP056A4002036  
MATTE BLACK / NEGRO MATE





**PAPER HOLDER  
WITHOUT COVER**  
PORTARROLLO SIN  
TAPA

17,7X9X5,5 CM  
6,97X3,54X2,17 IN



**WJP056A4001001**  
CHROME / CROMO



**WJP056A4001036**  
MATTE BLACK / NEGRO MATE



**FREE STANDING  
TOILET BRUSH**  
ESCOBILLERO  
SUELO

9,5X9,5X51,4 CM  
3,74X3,74X20,24 IN



**WJP056A9050001**  
CHROME / CROMO



**WJP056A9050036**  
MATTE BLACK / NEGRO MATE



**WASTE BIN**  
PAPELERA

19X19X28,1 CM  
7,48X7,48X11,06 IN

(10L)



**WJP056A9350001**  
NATURAL BAMBOO-CHROME / BAMBU  
NATURAL-CROMO



**WJP056A9350603**  
NATURAL BAMBOO-MATTE BLACK /  
BAMBU NATURAL-NEGRO MATE



# Extreme

Design by **Cosmic Studio**





# Extreme

Design by Cosmic Studio

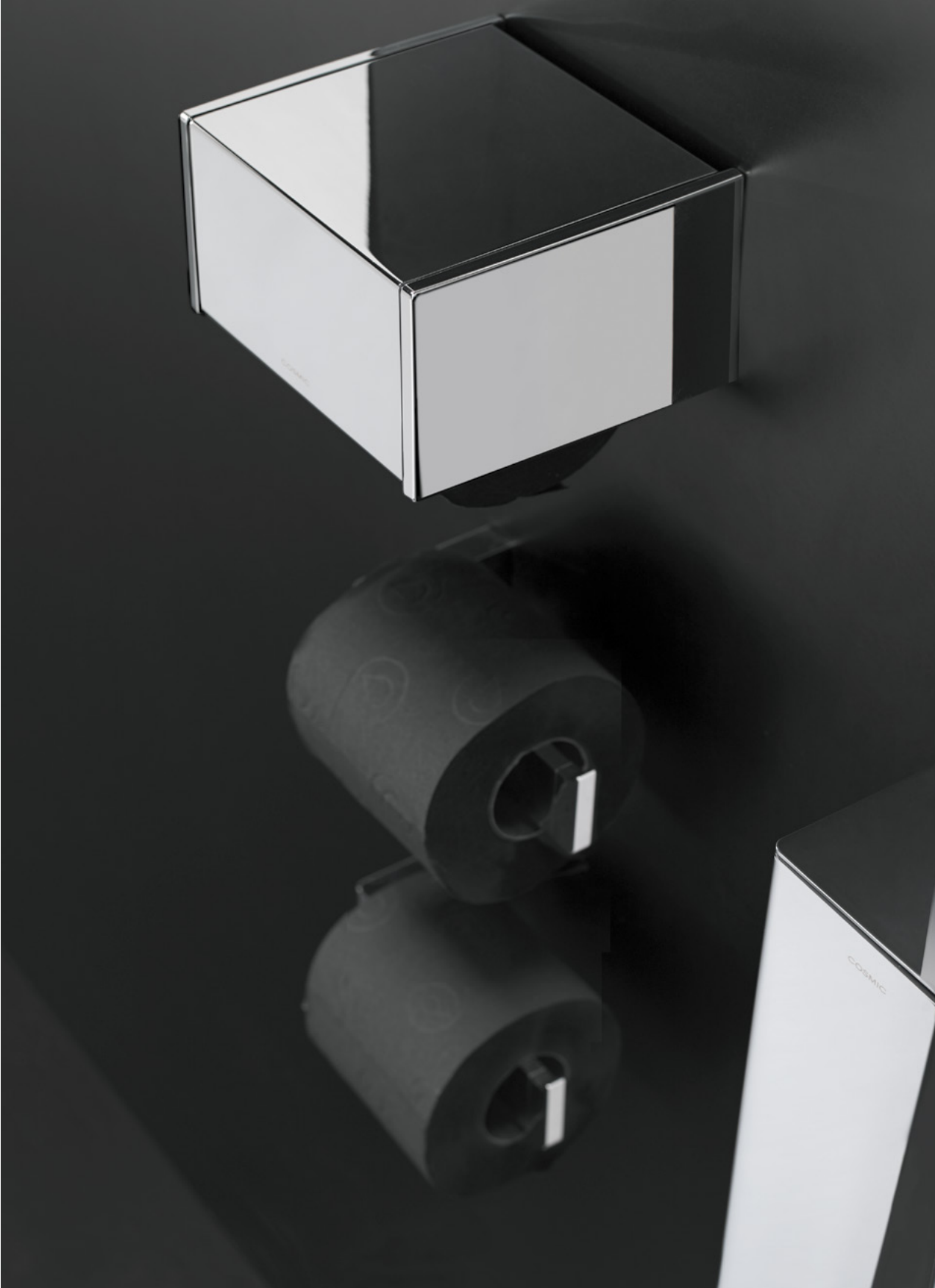

# 10

YEARS GUARANTEE  
AÑOS GARANTÍA

---

## COSMIC

**Extreme** has successfully passed the high demanding tests of long last durability and resistance to extreme uses (static charge or impact testing) to assure long last durability of the product.

Toda la gama **Extreme** ha superado con éxito exigentes tests de durabilidad y resistencia a usos extremos (cargas estáticas o test de impacto), para asegurar una larga vida al producto.



### FEATURES / CARACTERÍSTICAS

Easy installation: double pitch screw.  
Hidden attachments. Anti-corrosion.  
Tempered glass shelf (high safety).

Fácil instalación: tornillo de doble paso.  
Fijaciones ocultas. Anticorrosión.  
Estante de vidrio templado (alta seguridad).

### FINISHES / ACABADOS

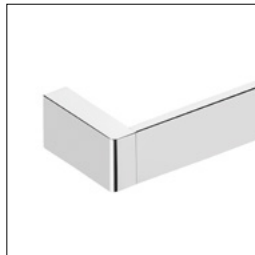

**001**  
Chrome  
Cromo



**061**  
Chrome - black  
Cromo - negro



⊙  
**HOOK**  
COLGADOR  
2X5X4,5 CM  
0,79X1,97X1,77 IN



**WJC253A0021001**  
CHROME / CROMO

⊙ △  
**FREE STANDING SOAP DISPENSER**  
DOSIFICADOR ENCIMERA  
8X7,5X16 CM  
3,15X2,95X6,3 IN



(225ML)

**WJC253A0004001**  
CHROME-BLACK / CROMO-NEGRO

⊙ △  
**WALL SOAP DISPENSER**  
DOSIFICADOR PARED  
8X8,5X16 CM  
3,15X3,35X6,3 IN



(225ML)

**WJC253A0005001**  
CHROME-BLACK / CROMO-NEGRO

⊙ △  
**FREE STANDING BRUSH HOLDER**  
PORTACEPILLOS ENCIMERA  
8X5X12 CM  
3,15X1,97X4,72 IN



**WJC253A00053001**  
CHROME-BLACK / CROMO-NEGRO

⊙ △  
**WALL TOOTHBRUSH HOLDER**  
PORTACEPILLOS PARED  
8X6X12 CM  
3,15X2,36X4,72 IN



**WJC253A00052001**  
CHROME-BLACK / CROMO-NEGRO

⊙  
**WALL SOAP DISH**  
JABONERA PARED  
14X10X2 CM  
5,51X3,94X0,79 IN



**WJC253A00032001**  
CHROME / CROMO

⊙ △  
**SHOWER SOAP DISH**  
JABONERA DE DUCHA  
30X12X4 CM  
11,81X4,72X1,57 IN



**WJC251A0049061**  
CHROME-BLACK / CROMO-NEGRO

⊙  
**TOWEL RACK**  
TOALLERO  
30X7X3,5 CM  
11,81X2,76X1,38 IN



**WJC253A00063001**  
CHROME / CROMO

⊙  
**TOWEL RACK**  
TOALLERO  
45X7X3,5 CM  
17,72X2,76X1,38 IN



**WJC253A00064001**  
CHROME / CROMO

⊙  
**TOWEL RACK**  
TOALLERO  
60X7X3,5 CM  
23,62X2,76X1,38 IN



**WJC253A00065001**  
CHROME / CROMO





# Extreme

Design by Cosmic Studio

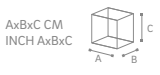

⊙  
TOWEL RACK  
TOALLERO

80X7X3,5 CM  
31,5X2,76X1,38 IN



WJC253A0066001  
CHROME / CROMO

⊙  
SWIVEL DOUBLE TOWEL RACK  
TOALLERO DOBLE GIRATORIO

40X5X3,5 CM  
15,75X1,97X1,38 IN



WJC253A0075001  
CHROME / CROMO

⊙△  
PAPER HOLDER WITH COVER  
PORTARROLLO CON TAPA

14,5X13X8 CM  
5,71X5,12X3,15 IN



WJC251A0059001  
CHROME / CROMO

⊙  
PAPER HOLDER WITHOUT COVER  
PORTARROLLO SIN TAPA

15X7X4 CM  
5,91X2,76X1,57 IN



WJC253A0058001  
CHROME / CROMO

⊙△  
FREE STANDING TOILET BRUSH  
ESCOBILLERO SUELO

10X8X46 CM  
3,94X3,15X18,11 IN



WJC253A0001001  
CHROME / CROMO

⊙△  
WALL TOILET BRUSH HOLDER  
ESCOBILLERO PARED

10X9X46 CM  
3,94X3,54X18,11 IN



WJC253A0000001  
CHROME / CROMO



# Geyser

Design by **Nahtrang**







**Geyser** has successfully passed the high demanding tests of long last durability and resistance to extreme uses (static charge or impact testing) to assure long last durability of the product.

Toda la gama **Geyser** ha superado con éxito exigentes tests de durabilidad y resistencia a usos extremos (cargas estáticas o test de impacto), para asegurar una larga vida al producto.



## FEATURES / CARACTERÍSTICAS

Accessories manufactured with stainless steel coated with matte paint. Wall-mounted pieces are made of Zamak coated with matte paint. Dual System: Installed with traditional screws or an adhesive bond. Easy installation: double pitch screw. Hidden attachments. Anti-corrosion.

Accesorios fabricados en acero inoxidable recubierto de una pintura mate. Las piezas con fijación a pared están fabricadas en Zamak recubierto de pintura mate. Sistema Dual: instalación tradicional con tornillo a la pared, o con la cinta adhesiva. Fácil instalación: tornillo de doble paso. Fijaciones ocultas. Anticorrosión.

## FINISHES / ACABADOS



**065**  
Matte white  
Blanco mate

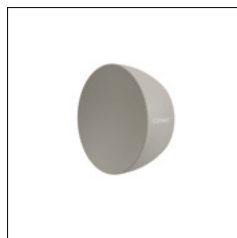

**090**  
Sand  
Arena



**089**  
Olive  
Olive

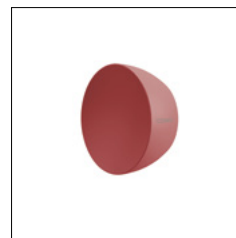

**088**  
Terracotta  
Terracota

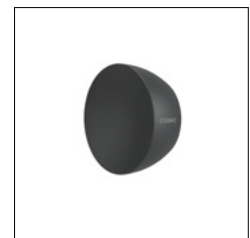

**036**  
Matte black  
Negro mate





**SMART  
FIX**



Easy installation  
without drilling

Fácil instalación  
sin taladro

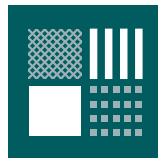

Works with differ-  
ent surfaces\*

Efectivo en dife-  
rentes superficies\*



Static load  
of 10 kg

Carga estática  
de 10 Kg



Removable  
accessories

Accesorios  
removibles



Quick, easy, silent  
installation

Montaje sin ruido,  
fácil y rápido

\* Ceramic, porcelain, glazed surfaces, compact marble, even surfaces with roughness up to 0.5 mm thickness.

\* Cerámica, porcelana, materiales vitrificados o mármoles compactos, e incluso superficies con una rugosidad de hasta 0,5 milímetros de espesor.



Dual SmartFix products require the SmartFix gluing kit ref. WJC341R1185000  
Los productos Dual SmartFix requieren del kit de encolado SmartFix ref. WJC341R1185000





# Accessories | Accesorios

Dual SmartFix products require the SmartFix gluing kit ref. WJC341R1185000  
Los productos Dual SmartFix requieren del kit de encolado SmartFix ref. WJC341R1185000

⊙  
HOOK  
COLGADOR  
5,7X5,7X2,5 CM  
2,24X2,24X0,98 IN

DUAL SMARTFIX



**NEW** WJC277A0022065  
MATTE WHITE / BLANCO MATE



**NEW** WJC277A0022090  
SAND / ARENA

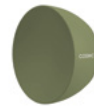

**NEW** WJC277A0022089  
OLIVE / OLIVE



**NEW** WJC277A0022088  
TERRACOTTA / TERRACOTA



**NEW** WJC277A0022036  
MATTE BLACK / NEGRO MATE

○  
FREE STANDING SOAP  
DISPENSER  
DOSIFICADOR ENCIMERA  
6X8,5X20 CM  
2,36X3,35X7,87 IN

(185ML)



WJC277A0004065  
MATTE WHITE / BLANCO MATE



**NEW** WJC277A0004090  
SAND / ARENA



**NEW** WJC277A0004089  
OLIVE / OLIVE



**NEW** WJC277A0004088  
TERRACOTTA / TERRACOTA



WJC277A0004036  
MATTE BLACK / NEGRO MATE



○  
WALL SOAP DISPENSER  
DOSIFICADOR PARED

5,1X9,1X21,2 CM  
2,01X3,58X8,35 IN

DUAL SMARTFIX



**NEW** WJC277A0005065  
MATTE WHITE / BLANCO MATE



**NEW** WJC277A0005090  
SAND / ARENA



**NEW** WJC277A0005089  
OLIVE / OLIVE



**NEW** WJC277A0005088  
TERRACOTTA / TERRACOTA



**NEW** WJC277A0005036  
MATTE BLACK / NEGRO MATE



Dual SmartFix products require the SmartFix gluing kit ref. WJC341R1185000  
Los productos Dual SmartFix requieren del kit de encolado SmartFix ref. WJC341R1185000

○  
**FREE STANDING BRUSH  
HOLDER**  
PORTACEPILLOS ENCIMERA  
7,5X7,5X14,5 CM  
2,95X2,95X5,71 IN



**WJC277A0051065**  
MATTE WHITE / BLANCO MATE



**NEW WJC277A0051090**  
SAND / ARENA



**NEW WJC277A0051089**  
OLIVE / OLIVE



**NEW WJC277A0051088**  
TERRACOTTA / TERRACOTA



**WJC277A0051036**  
MATTE BLACK / NEGRO MATE

○  
**WALL TOOTHBRUSH HOLDER**  
PORTACEPILLOS PARED  
6,3X7,77X16,1 CM  
2,48X3,06X6,34 IN  
DUAL SMARTFIX



**NEW WJC277A0052065**  
MATTE WHITE / BLANCO MATE



**NEW WJC277A0052090**  
SAND / ARENA



**NEW WJC277A0052089**  
OLIVE / OLIVE



**NEW WJC277A0052088**  
TERRACOTTA / TERRACOTA



**NEW WJC277A0052036**  
MATTE BLACK / NEGRO MATE



○  
FREE STANDING SOAP DISH  
JABONERA ENCIMERA

13X13X2 CM  
5,12X5,12X0,79 IN



WJC277A0032065  
MATTE WHITE / BLANCO MATE



**NEW** WJC277A0032090  
SAND / ARENA



**NEW** WJC277A0032089  
OLIVE / OLIVE



**NEW** WJC277A0032088  
TERRACOTTA / TERRACOTA



WJC277A0032036  
MATTE BLACK / NEGRO MATE

⊙  
SHOWER SOAP DISH  
JABONERA DE DUCHA

30,2X13,1X4 CM  
11,89X5,16X1,57 IN

DUAL SMARTFIX



**NEW** WJC277A0033065  
MATTE WHITE / BLANCO MATE



**NEW** WJC277A0033090  
SAND / ARENA



**NEW** WJC277A0033089  
OLIVE / OLIVE



**NEW** WJC277A0033088  
TERRACOTTA / TERRACOTA



**NEW** WJC277A0033036  
MATTE BLACK / NEGRO MATE



Dual SmartFix products require the SmartFix gluing kit ref. WJC341R1185000  
Los productos Dual SmartFix requieren del kit de encolado SmartFix ref. WJC341R1185000

○●  
**FREE STANDING MAGNIFY-  
ING MIRROR**

ESPEJO AUMENTO ENCI-  
MERA

18X8,5X24 CM  
7,09X3,35X9,45 IN

(X5)



**WJC277A0084065**  
MATTE WHITE / BLANCO MATE



**NEW WJC277A0084090**  
SAND / ARENA



**NEW WJC277A0084089**  
OLIVE / OLIVE



**NEW WJC277A0084088**  
TERRACOTTA / TERRACOTA



**WJC277A0084036**  
MATTE BLACK / NEGRO MATE



©  
TOWEL RACK  
TOALLERO  
40X7,1X5 CM  
15,75X2,8X1,97 IN

DUAL SMARTFIX



**NEW** WJC277A0064065  
MATTE WHITE / BLANCO MATE



**NEW** WJC277A0064090  
SAND / ARENA



**NEW** WJC277A0064089  
OLIVE / OLIVE



**NEW** WJC277A0064088  
TERRACOTTA / TERRACOTA



**NEW** WJC277A0064036  
MATTE BLACK / NEGRO MATE



Dual SmartFix products require the SmartFix gluing kit ref. WJC341R1185000  
Los productos Dual SmartFix requieren del kit de encolado SmartFix ref. WJC341R1185000

⊙  
TOWEL RING  
TOALLERO ARO  
21,4X4X21,4 CM  
8,43X1,57X8,43 IN

DUAL SMARTFIX



**NEW** WJC277A0071065  
MATTE WHITE / BLANCO MATE



**NEW** WJC277A0071090  
SAND / ARENA



**NEW** WJC277A0071089  
OLIVE / OLIVE



**NEW** WJC277A0071088  
TERRACOTTA / TERRACOTA



**NEW** WJC277A0071036  
MATTE BLACK / NEGRO MATE

⊙  
PAPER HOLDER WITHOUT  
COVER  
PORTARROLLO SIN TAPA  
15,9X7X5 CM  
6,26X2,76X1,97 IN

DUAL SMARTFIX



**NEW** WJC277A0062065  
MATTE WHITE / BLANCO MATE



**NEW** WJC277A0062090  
SAND / ARENA



**NEW** WJC277A0062089  
OLIVE / OLIVE



**NEW** WJC277A0062088  
TERRACOTTA / TERRACOTA



**NEW** WJC277A0062036  
MATTE BLACK / NEGRO MATE



○  
FREE STANDING TOILET  
BRUSH

ESCOBILLERO SUELO

10,5X10,5X40 CM  
4,13X4,13X15,75 IN



WJC277A0000065  
MATTE WHITE / BLANCO MATE



**NEW** WJC277A0000090  
SAND / ARENA



**NEW** WJC277A0000089  
OLIVE / OLIVE



**NEW** WJC277A0000088  
TERRACOTTA / TERRACOTA



WJC277A0000036  
MATTE BLACK / NEGRO MATE

○  
WALL TOILET BRUSH  
HOLDER

ESCOBILLERO PARED

8,9X10,4X39,4 CM  
3,5X4,09X15,51 IN

DUAL SMARTFIX



**NEW** WJC277A0001065  
MATTE WHITE / BLANCO MATE



**NEW** WJC277A0001090  
SAND / ARENA



**NEW** WJC277A0001089  
OLIVE / OLIVE



**NEW** WJC277A0001088  
TERRACOTTA / TERRACOTA



**NEW** WJC277A0001036  
MATTE BLACK / NEGRO MATE

○  
WASTE BIN  
PAPELERA

20,5X20,5X26 CM  
8,07X8,07X10,24 IN

(5L)



WJC277A0002065  
MATTE WHITE / BLANCO MATE



WJC277A0002087  
STONE / PIEDRA



WJC277A0002036  
MATTE BLACK / NEGRO MATE

Dual SmartFix products require the SmartFix gluing kit ref. WJC341R1185000  
Los productos Dual SmartFix requieren del kit de encolado SmartFix ref. WJC341R1185000

○△  
STOOL  
TABURETE  
31X31X41 CM  
12,2X12,2X16,14 IN



WJC277A0006065  
MATTE WHITE / BLANCO MATE



**NEW** WJC277A0006090  
SAND / ARENA



**NEW** WJC277A0006089  
OLIVE / OLIVE



**NEW** WJC277A0006088  
TERRACOTTA / TERRACOTA



WJC277A0006036  
MATTE BLACK / NEGRO MATE

SMARTFIX KIT  
SMARTFIX KIT ENCOLAR



10 GR.

**NEW** WJC341R1185000



# Kubic

Design by **Cosmic Studio**







## DUAL SYSTEM / SISTEMA DUAL

Our updated Kubic collection now includes a dual installation system for installing bathroom accessories with or without a drill. Smart-fix adhesive, designed exclusively for our firm, means that bathroom accessories can be installed without drilling holes in the wall.

La colección Kubic presenta como novedad el sistema de instalación dual, que permite sujetar los accesorios de baño con y sin taladros. Con el adhesivo Smart-fix, elaborado en exclusiva para la firma, se facilita el montaje sin la necesidad de hacer agujeros en la pared.

## BLACK EDITION / BLACK EDITION

Black Edition is an extra-matt black finish, the result of a process widely used in the automotive sector, electrophoresis. This process provides a high resistance to scratches, uniformity in the finish and a soft and pleasant texture to the touch.

Black Edition es un acabado negro extra-mate, resultado de un proceso muy utilizado en el sector automovilístico, la electroforesis. Este proceso aporta una gran resistencia a las rayaduras, uniformidad en el acabado y una textura suave y agradable al tacto.

**Kubic** has successfully passed the high demanding tests of long last durability and resistance to extreme uses (static charge or impact testing) to assure long last durability of the product. All products come with 10 years warranty, except for waste bins and stools, which come with 3 years warranty.

Toda la gama **Kubic** ha superado con éxito exigentes tests de durabilidad y resistencia a usos extremos (cargas estáticas o test de impacto), para asegurar una larga vida al producto. Todos los artículos tienen 10 años de garantía a excepción de las papeleras y los taburetes que tienen una garantía de 3 años.



Easy installation without drilling

Fácil instalación sin taladro

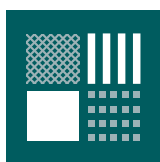

Works with different surfaces\*

Efectivo en diferentes superficies\*



Static load of 10 kg

Carga estática de 10 Kg



Removable accessories

Accesorios removibles



Quick, easy, silent installation

Montaje sin ruido, fácil y rápido

# SMART FIX

\* Ceramic, porcelain, glazed surfaces, compact marble, even surfaces with roughness up to 0.5 mm thickness.

\* Cerámica, porcelana, materiales vitrificados o mármoles compactos, e incluso superficies con una rugosidad de hasta 0,5 milímetros de espesor.



Dual SmartFix products require the SmartFix gluing kit ref. WJC341R1185000  
Los productos Dual SmartFix requieren del kit de encolado SmartFix ref. WJC341R1185000

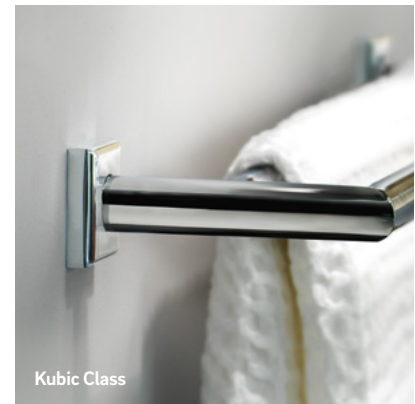
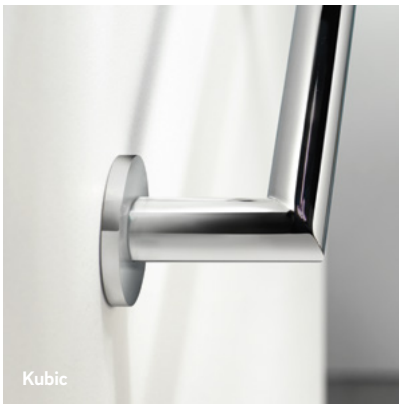

## Customize your Kubic collection Personaliza tu colección Kubic

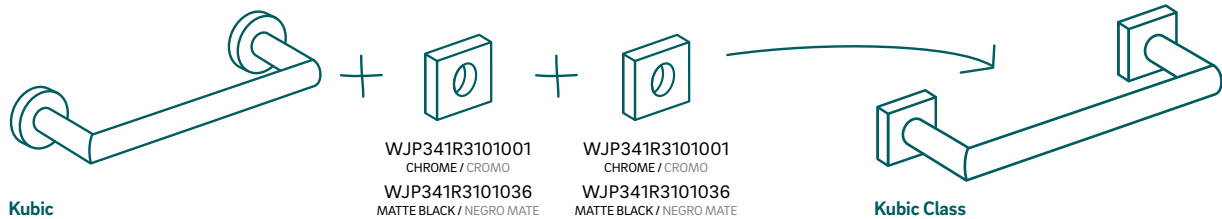
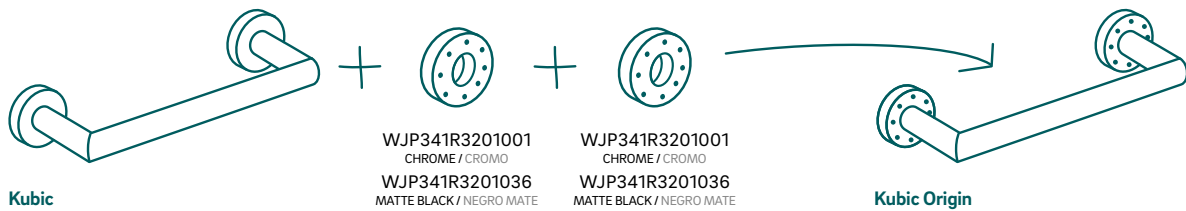

The towel rack shelf ref. WJP033A5110001 / WJP033A5110036 needs the escutcheons WJP341R3102001 / WJP341R3102036 (Kubic Class) and WJP341R3202001 / WJP341R3202036 (Kubic Origin).  
El toallero estante ref. WJP033A5110001 / WJP033A5110036 necesita los embellecedores WJP341R3102001 / WJP341R3102036 (Kubic Class) y WJP341R3202001 / WJP341R3202036 (Kubic Origin).

The bathtub handle ref. WJP036A0535001 does not have interchangeable escutcheons.  
La asa bañera ref. WJP036A0535001 no tiene los embellecedores intercambiables.



©  
**HOOK**  
COLGADOR  
4,5X4,8X4,5 CM  
1,77X1,89X1,77 IN

DUAL SMARTFIX



**NEW** WJP033A4011001  
CHROME / CROMO



**NEW** WJP036A4011001  
CHROME / CROMO



**NEW** WJP043A4011001  
CHROME / CROMO



**NEW** WJP033A4011036  
MATTE BLACK / NEGRO MATE



**NEW** WJP036A4011036  
MATTE BLACK / NEGRO MATE



**NEW** WJP043A4011036  
MATTE BLACK / NEGRO MATE



Dual SmartFix products require the SmartFix gluing kit ref. WJC341R1185000  
Los productos Dual SmartFix requieren del kit de encolado SmartFix ref. WJC341R1185000

©  
**HOOK**  
COLGADOR  
3,5X4X3,5 CM  
1,38X1,57X1,38 IN



**WJP033A3011001**  
CHROME / CROMO



**WJP036A3011001**  
CHROME / CROMO



**WJP043A3011001**  
CHROME / CROMO



**WJP033A3011036**  
MATTE BLACK / NEGRO MATE



**WJP036A3011036**  
MATTE BLACK / NEGRO MATE



**WJP043A3011036**  
MATTE BLACK / NEGRO MATE





## HOOK

COLGADOR

4,5X8X4,5 CM  
1,77X3,15X1,77 IN



DUAL SMARTFIX

WJP033A3001001  
CHROME / CROMO

WJP033A3001036  
MATTE BLACK / NEGRO MATE



## FREE STANDING SOAP DISPENSER

DOSIFICADOR ENCIMERA

7X7X20 CM  
2,76X2,76X7,87 IN



(125ML)

WJP036A7831001  
CHROME / CROMO

WJP036A7831036  
MATTE BLACK / NEGRO MATE



## FREE STANDING BRUSH-HOLDER

PORTACEPILLOS ENCIMERA

9X9X11 CM  
3,54X3,54X4,33 IN



WJP036A7050001  
CHROME / CROMO

WJP036A7050036  
MATTE BLACK / NEGRO MATE



## SHOWER SOAP DISH

JABONERA DE DUCHA

32X13X9 CM  
12,6X5,12X3,54 IN



DUAL SMARTFIX

WJP033A6020001  
CHROME / CROMO

WJP033A6020036  
MATTE BLACK / NEGRO MATE



## CORNER SHOWER BASKET

JABONERA DE DUCHA  
RINCÓN

15,5X23X3 CM  
6,1X9,06X1,18 IN



WJP036A6032001  
CHROME / CROMO



Dual SmartFix products require the SmartFix gluing kit ref. WJC341R1185000  
Los productos Dual SmartFix requieren del kit de encolado SmartFix ref. WJC341R1185000

©  
**TISSUE BOX**  
CAJA KLEENEX  
25X15X6 CM  
9,84X5,91X2,36 IN



**WJP036A9402001**  
CHROME / CROMO



⊙  
GLASS SHELF  
ESTANTE VIDRIO  
40X15X5 CM  
15,75X5,91X1,97 IN



DUAL SMARTFIX

WJP033A5040001  
CHROME / CROMO

⊙  
GLASS SHELF  
ESTANTE VIDRIO  
60X15X5 CM  
23,62X5,91X1,97 IN



DUAL SMARTFIX

WJP033A5060001  
CHROME / CROMO

⊙  
TOWEL RACK  
TOALLERO  
30X9X5 CM  
11,81X3,54X1,97 IN



DUAL SMARTFIX

WJP033A1030001  
CHROME / CROMO



WJP033A1030036  
MATTE BLACK / NEGRO MATE



Dual SmartFix products require the SmartFix gluing kit ref. WJC341R1185000  
Los productos Dual SmartFix requieren del kit de encolado SmartFix ref. WJC341R1185000

⊙  
TOWEL RACK  
TOALLERO  
40X9X5 CM  
15,75X3,54X1,97 IN



WJP033A1040001  
CHROME / CROMO



WJP033A1040036  
MATTE BLACK / NEGRO MATE

DUAL SMARTFIX

⊙  
TOWEL RACK  
TOALLERO  
50X9X5 CM  
19,69X3,54X1,97 IN



WJP033A1050001  
CHROME / CROMO

DUAL SMARTFIX

⊙  
TOWEL RACK  
TOALLERO  
60X9X5 CM  
23,62X3,54X1,97 IN



WJP033A1060001  
CHROME / CROMO



WJP033A1060036  
MATTE BLACK / NEGRO MATE

DUAL SMARTFIX



⊙  
**DOUBLE TOWEL RACK**  
TOALLERO DOBLE

60X11X5 CM  
23,62X4,33X1,97 IN

DUAL SMARTFIX



WJP033A1442001  
CHROME / CROMO



⊙  
**DOUBLE LATERAL TOWEL RACK**  
TOALLERO LATERAL DOBLE

36X5X13 CM  
14,17X1,97X5,12 IN

DUAL SMARTFIX



WJP033A1401001  
CHROME / CROMO



⊙  
**TOWEL RING**  
TOALLERO ARO

23X7,5X14 CM  
9,06X2,95X5,51 IN

DUAL SMARTFIX



WJP033A2057001  
CHROME / CROMO



WJP033A2057036  
MATTE BLACK / NEGRO MATE

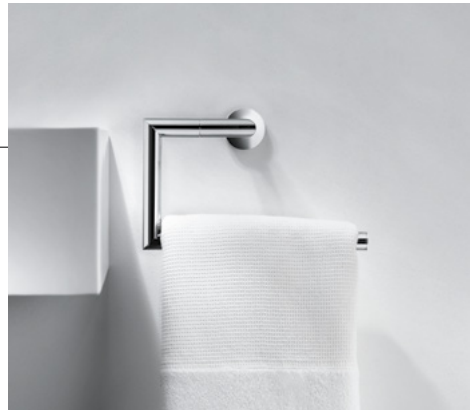

⊙  
**TOWEL RACK SHELF**  
TOALLERO ESTANTE

60X27X9 CM  
23,62X10,63X3,54 IN

DUAL SMARTFIX



WJP033A5110001  
CHROME / CROMO



⊙  
**GRAB BAR**  
ASA BAÑERA

35X10X6 CM  
13,78X3,94X2,36 IN



WJP036A0536001  
CHROME / CROMO



Dual SmartFix products require the SmartFix gluing kit ref. WJC341R1185000  
Los productos Dual SmartFix requieren del kit de encolado SmartFix ref. WJC341R1185000

⊙  
**GRAB BAR**  
ASA BAÑERA  
35X9X6 CM  
13,78X3,54X2,36 IN



**WJP036A0535001**  
CHROME / CROMO

⊙  
**RIGHT PAPER HOLDER WITH COVER**  
PORTARROLLO CON TAPA DERECHO  
14X13X9 CM  
5,51X5,12X3,54 IN



**WJP036A4005001**  
CHROME / CROMO



**WJP036A4005036**  
MATTE BLACK / NEGRO MATE

⊙  
**LEFT PAPER HOLDER WITH COVER**  
PORTARROLLO CON TAPA IZQUIERDO  
14X13X9 CM  
5,51X5,12X3,54 IN



**WJP036A4012001**  
CHROME / CROMO

⊙  
**PAPER HOLDER WITHOUT COVER**  
PORTARROLLO SIN TAPA  
17X9X5 CM  
6,69X3,54X1,97 IN



**WJP033A1481001**  
CHROME / CROMO



**WJP033A1481036**  
MATTE BLACK / NEGRO MATE

⊙  
**VERTICAL PAPER HOLDER**  
PORTARROLLO VERTICAL  
6X9X17 CM  
2,36X3,54X6,69 IN



**WJP033A4042001**  
CHROME / CROMO



**WJP033A4042036**  
MATTE BLACK / NEGRO MATE



⊙  
**FREE STANDING TOILET BRUSH**

ESCOBILLERO SUELO

10X11X33 CM  
3,94X4,33X12,99 IN



**NEW** WJP036A9051001  
CHROME / CROMO



WJP036A9051036  
MATTE BLACK / NEGRO MATE

⊙  
**WALL TOILET BRUSH HOLDER**

ESCOBILLERO PARED

10X12X33 CM  
3,94X4,72X12,99 IN

DUAL SMARTFIX



**NEW** WJP036A9002001  
CHROME / CROMO



WJP036A9002036  
MATTE BLACK / NEGRO MATE

⊙ ⊙  
**WASTE BIN**

PAPELERA

17X17X29 CM  
6,69X6,69X11,42 IN

(8L)



WJP036A9351001  
CHROME / CROMO

**SMARTFIX KIT**

SMARTFIX KIT ENCOLAR

10 GR.



**NEW** WJC341R1185000

**FLANGE WITH DOTS (1UD)**

EMBELLECEDOR KUBIC  
PUNTOS (1UD)



WJP341R3201001  
CHROME / CROMO



WJP341R3201036  
MATTE BLACK / NEGRO MATE



Dual SmartFix products require the SmartFix gluing kit ref. WJC341R1185000  
Los productos Dual SmartFix requieren del kit de encolado SmartFix ref. WJC341R1185000

FLANGE SQUARE (1UD)  
EMBELLECEDOR KUBIC  
CUADRADA (1UD)



WJP341R3101001  
CHROME / CROMO

WJP341R3101036  
MATTE BLACK / NEGRO MATE

FLANGE WITH DOTS (1UD)  
TOWEL SHELF  
EMBELLECEDOR KUBIC  
PUNTOS (1UD) T.ESTANTE



WJP341R3202001  
CHROME / CROMO

WJP341R3202036  
MATTE BLACK / NEGRO MATE

FLANGE SQUARE (1UD)  
TOWEL SHELF  
EMBELLECEDOR KUBIC CUA-  
DRADA (1UD) T.ESTANTE



WJP341R3102001  
CHROME / CROMO

WJP341R3102036  
MATTE BLACK / NEGRO MATE



# Line

Design by Ricard Ferrer







Easy installation  
without drilling

Fácil instalación  
sin taladro



Bonded with  
high adhesion  
adhesive (3M)

Fijación con  
adhesivo de alta  
adherencia (3M)



Quick, easy, silent  
installation

Montaje sin ruido,  
fácil y rápido



Static load  
of 5 kg

Carga estática  
de 5 KG



Do not use on  
painted surfaces  
and gypsum walls

No usar en  
superficies pintadas  
ni en paredes rugosas

**QUICK  
FIX**



**QUICK FIX / QUICK FIX**

Our updated Line collection now includes a dual installation system for installing bathroom accessories with or without a drill. Quick Fix adhesive, designed exclusively for our firm, means that bathroom accessories can be installed without drilling holes in the wall.

La colección Line presenta como novedad el sistema de instalación dual, que permite sujetar los accesorios de baño con y sin taladros. Con el adhesivo Quick Fix, elaborado en exclusiva para la firma, se facilita el montaje sin la necesidad de hacer agujeros en la pared.



**FEATURES / CARACTERÍSTICAS**

Easy installation: double pitch screw. Hidden attachments. Anti-corrosion.

Fácil instalación: tornillo de doble paso. Fijaciones ocultas. Anticorrosión.



Line has successfully passed the high demanding tests of long last durability and resistance to extreme uses (static charge or impact testing) to assure long last durability of the product. All products come with 10 years warranty.

Toda la gama Line ha superado con éxito exigentes tests de durabilidad y resistencia a usos extremos (cargas estáticas o test de impacto), para asegurar una larga vida al producto. Todos los artículos tienen 10 años de garantía.

**FINISHES / ACABADOS**



**001**  
Chrome  
Cromo



**003**  
Matte stainless steel  
Inox mate

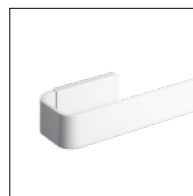

**065**  
Matte white  
Blanco mate

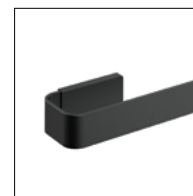

**036**  
Matte black  
Negro mate



○△  
**HOOK**  
COLGADOR  
3X2,9X11 CM  
1,18X1,14X4,33 IN

DUAL QUICKFIX



**WJB269A0021001**  
CHROME / CROMO



**NEW NEA WJB350A0021003**  
MATTE STAINLESS STEEL / INOX MATE



**NEW NEA WJB350A0021065**  
MATTE WHITE / BLANCO MATE



**NEW NEA WJB350A0021036**  
MATTE BLACK / NEGRO MATE

○△  
**FREE STANDING SOAP DISPENSER**  
DOSIFICADOR ENCIMERA

6,3X8,2X16 CM  
2,48X3,23X6,3 IN

(370 ML)



**WJB269A0004001**  
CHROME / CROMO



**NEW NEA WJB350A0004003**  
MATTE STAINLESS STEEL / INOX MATE



**NEW NEA WJB350A0004065**  
MATTE WHITE / BLANCO MATE



**NEW NEA WJB350A0004036**  
MATTE BLACK / NEGRO MATE

○△  
**FREE STANDING BRUSH-HOLDER**  
PORTACEPILLOS ENCIMERA

6,3X6,3X13,7 CM  
2,48X2,48X5,39 IN



**WJB269A0053001**  
CHROME / CROMO



**NEW NEA WJB350A0051003**  
MATTE STAINLESS STEEL / INOX MATE



**NEW NEA WJB350A0051065**  
MATTE WHITE / BLANCO MATE



**NEW NEA WJB350A0051036**  
MATTE BLACK / NEGRO MATE

○△  
**SHOWER SOAP DISH**  
JABONERA DE DUCHA

30X10,6X8 CM  
11,81X4,17X3,15 IN

DUAL QUICKFIX

FÁCIL EXTRACCIÓN PARA SU LIMPIEZA. JABONERA EXTRAÍBLE



**WJB269A0049001**  
CHROME / CROMO



**WJC419A0049036**  
MATTE BLACK / NEGRO MATE

○△  
**CORNER SHOWER BASKET**  
JABONERA DE DUCHA RINCÓN

21,7X21,9X8 CM  
8,54X8,62X3,15 IN

DUAL QUICKFIX

FÁCIL EXTRACCIÓN PARA SU LIMPIEZA. JABONERA EXTRAÍBLE



**WJB269A0050001**  
CHROME / CROMO



**WJC419A0050036**  
MATTE BLACK / NEGRO MATE





○△  
TOWEL RACK  
TOALLERO  
40X6,5X3 CM  
15,75X2,56X1,18 IN

DUAL QUICKFIX



WJB269A0064001  
CHROME / CROMO



**NEW NEA** WJB350A0064003  
MATTE STAINLESS STEEL / INOX MATE



**NEW NEA** WJB350A0064065  
MATTE WHITE / BLANCO MATE



**NEW NEA** WJB350A0064036  
MATTE BLACK / NEGRO MATE

○△  
TOWEL RACK  
TOALLERO  
60X6,5X3 CM  
23,62X2,56X1,18 IN

DUAL QUICKFIX



WJB269A0065001  
CHROME / CROMO



○△  
TOWEL RING  
TOALLERO ARO  
12X3X12 CM  
4,72X1,18X4,72 IN



**WJB269A0071001**  
CHROME / CROMO

DUAL QUICKFIX

○△  
TOWEL RACK SHELF  
TOALLERO ESTANTE  
50X21,4X8,5 CM  
19,69X8,43X3,35 IN



**WJB269A0068001**  
CHROME / CROMO

DUAL QUICKFIX

○△  
PAPER HOLDER WITH COVER  
PORTARROLLO CON TAPA  
15,2X11X8 CM  
5,98X4,33X3,15 IN



**WJB269A0059001**  
CHROME / CROMO

DUAL QUICKFIX

○△  
PAPER HOLDER WITHOUT COVER  
PORTARROLLO SIN TAPA  
15,2X6,4X3 CM  
5,98X2,52X1,18 IN



**WJB269A0058001**  
CHROME / CROMO

DUAL QUICKFIX



**NEW NEA WJB350A0058003**  
MATTE STAINLESS STEEL / INOX MATE



**NEW NEA WJB350A0058065**  
MATTE WHITE / BLANCO MATE



**NEW NEA WJB350A0058036**  
MATTE BLACK / NEGRO MATE

○△  
FREE STANDING TOILET BRUSH  
ESCOBILLERO SUELO  
9,3X9,2X35,6 CM  
3,66X3,62X14,02 IN



**WJB269A0000001**  
CHROME / CROMO



**NEW NEA WJB350A0001003**  
MATTE STAINLESS STEEL / INOX MATE



**NEW NEA WJB350A0001065**  
MATTE WHITE / BLANCO MATE



**NEW NEA WJB350A0001036**  
MATTE BLACK / NEGRO MATE



○△  
**WASTE BIN**  
 PAPELERA  
 20,5X20,5X30 CM  
 8,07X8,07X11,81 IN  
 (5L)



**WJB269A0002001**  
 CHROME / CROMO



**WJB269A0002002**  
 GLOSSY STAINLESS STEEL / INOX BRILLO



# Logic

Design by **Cosmic Studio**

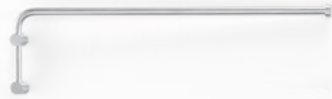





Logic has successfully passed the high demanding tests of long last durability and resistance to extreme uses (static charge or impact testing) to assure long last durability of the product.

Toda la gama Logic ha superado con éxito exigentes tests de durabilidad y resistencia a usos extremos (cargas estáticas o test de impacto), para asegurar una larga vida al producto.



## FEATURES / CARACTERÍSTICAS

Easy installation: double pitch screw.  
Hidden attachments. Anti-corrosion.

Fácil instalación: tornillo de doble paso.  
Fijaciones ocultas. Anticorrosión.



Optional disc (30 mm Ø) for safer installation on plasterboard walls included.

Incluido disco opcional (30 mm Ø) para una instalación más segura en paredes de yeso y cartón-yeso.

## FINISHES / ACABADOS



**003**  
Matte  
Mate



**002**  
Bright  
Brillo

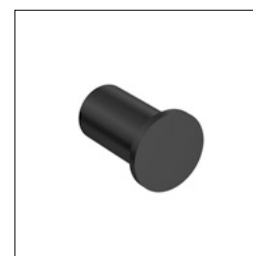

**036**  
Soft Black  
Soft Black

Smooth, consistent and pleasant to the touch

Textura suave, regular y agradable al tacto

High resistance Non-scratch

Alta resistencia a las rayadas

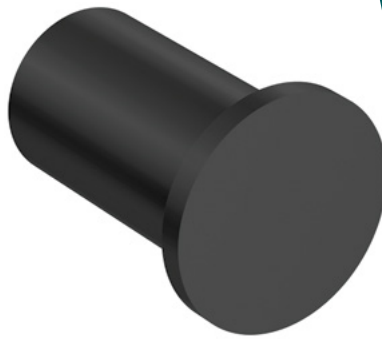

**Innovation in the bathroom sector**  
**Innovación en el sector del baño**

Completely uniform finish

Uniformidad en el acabado

## Soft Black

**A process widely used in the automobile industry to protect bodywork**

**Un proceso muy utilizado en el sector automovilístico para la protección de las carrocerías**

Application of a process widely used in the **automobile industry** to protect bodywork, thanks to the **research** and **development** carried out by the Cosmic team. An **innovation** in the bathroom sector. Completely **uniform finish**, which makes it **smooth, consistent** and **pleasant to the touch**. **High resistance Non-scratch**.

Aplicación de un proceso muy utilizado en el **sector automovilístico** para la protección de las carrocerías, gracias a la **investigación** y **desarrollo** realizada por el equipo de Cosmic.

**Innovación** en el sector del baño. **Uniformidad** en el acabado, consiguiendo una **textura suave, regular** y **agradable al tacto**. **Alta resistencia a las rayadas**.



○  
HOOK  
COLGADOR  
3X4X3 CM  
1,18X1,57X1,18 IN



WJC226A0121003   
MATTE STAINLESS STEEL / INOX MATE



WJC226A0121002   
GLOSSY STAINLESS STEEL / INOX BRILLO



WJC226A0121036   
MATTE BLACK / NEGRO MATE

○  
HOOK  
COLGADOR  
1,6X6,5X1,6 CM  
0,63X2,56X0,63 IN



WJC226A0021003   
MATTE STAINLESS STEEL / INOX MATE



WJC226A0021002   
GLOSSY STAINLESS STEEL / INOX BRILLO



WJC226A0021036   
MATTE BLACK / NEGRO MATE



○△  
FREE STANDING SOAP  
DISPENSER  
DOSIFICADOR ENCIMERA  
6X8,5X16,5 CM  
2,36X3,35X6,5 IN  
  
(200ML)



WJC226A0053003   
MATTE STAINLESS STEEL / INOX MATE



WJC226A0053002   
GLOSSY STAINLESS STEEL / INOX BRILLO



WJC226A0053036   
MATTE BLACK / NEGRO MATE





○△  
WALL SOAP DISPENSER  
DOSIFICADOR PARED

6X11X16,5 CM  
2,36X4,33X6,5 IN

(200ML)



WJC226A0004003 S  
MATTE STAINLESS STEEL / INOX MATE



WJC226A0004002 S  
GLOSSY STAINLESS STEEL / INOX BRILLO



WJC226A0004036 S  
MATTE BLACK / NEGRO MATE

○△  
FREE STANDING BRUSH  
HOLDER  
PORTACEPILLOS ENCIMERA

6X6X14 CM  
2,36X2,36X5,51 IN



WJC226A0051003  
BRUSHED STEEL / INOX CEPILLADO



WJC226A0051002  
GLOSSY STAINLESS STEEL / INOX BRILLO



WJC226A0051036 S  
MATTE BLACK / NEGRO MATE



○△  
WALL TOOTHBRUSH HOLDER  
PORTACEPILLOS PARED

6X9X14 CM  
2,36X3,54X5,51 IN



WJC226A0003003  
MATTE STAINLESS STEEL / INOX MATE



WJC226A0003002 S  
GLOSSY STAINLESS STEEL / INOX BRILLO



WJC226A0003036 S  
MATTE BLACK / NEGRO MATE

○  
**SHOWER SOAP DISH**  
JABONERA DE DUCHA  
20X12X2,5 CM  
7,87X4,72X0,98 IN



**WJC226A0039003**  
MATTE STAINLESS STEEL / INOX MATE



**WJC226A0039036**   
MATTE BLACK / NEGRO MATE

○  
**CORNER SHOWER BASKET**  
JABONERA DE DUCHA  
RINCÓN  
18X18X2,5 CM  
7,09X7,09X0,98 IN



**WJC226A0030003**   
MATTE STAINLESS STEEL / INOX MATE



**WJC226A0030036**  
MATTE BLACK / NEGRO MATE



O  
SHELF  
ESTANTE  
40X10,5X1,6 CM  
15,75X4,13X0,63 IN



WJC226A0046003 S  
MATTE STAINLESS STEEL / INOX MATE



WJC226A0046002  
GLOSSY STAINLESS STEEL / INOX BRILLO



WJC226A0046036 S  
MATTE BLACK / NEGRO MATE

O  
CORNER SHELF  
ESTANTE RINCÓN  
23,5X23,5X1,6 CM  
9,25X9,25X0,63 IN



WJC226A0043003 S  
MATTE STAINLESS STEEL / INOX MATE



WJC226A0043002 S  
GLOSSY STAINLESS STEEL / INOX BRILLO



WJC226A0043036 S  
MATTE BLACK / NEGRO MATE

O  
GLASS SHELF  
ESTANTE VIDRIO  
57,5X9,5X1,6 CM  
22,64X3,74X0,63 IN



WJC226A0045003  
MATTE STAINLESS STEEL / INOX MATE



WJC226A0045002  
GLOSSY STAINLESS STEEL / INOX BRILLO



WJC226A0045036  
MATTE BLACK / NEGRO MATE

O  
TOWEL RACK  
TOALLERO  
39,5X6,5X1,6 CM  
15,55X2,56X0,63 IN



WJC226A0064003 S  
MATTE STAINLESS STEEL / INOX MATE



WJC226A0064002 S  
GLOSSY STAINLESS STEEL / INOX BRILLO



WJC226A0064036 S  
MATTE BLACK / NEGRO MATE

O  
TOWEL RACK  
TOALLERO  
59,5X6,5X1,6 CM  
23,43X2,56X0,63 IN



WJC226A0065003 S  
MATTE STAINLESS STEEL / INOX MATE



WJC226A0065002 S  
GLOSSY STAINLESS STEEL / INOX BRILLO



WJC226A0065036 S  
MATTE BLACK / NEGRO MATE



○  
**DOUBLE TOWEL RACK**  
TOALLERO DOBLE  
60X10X1,6 CM  
23,62X3,94X0,63 IN



**WJC226A0061003**  
MATTE STAINLESS STEEL / INOX MATE



**WJC226A0061002**  
GLOSSY STAINLESS STEEL / INOX BRILLO



**WJC226A0061036**  
MATTE BLACK / NEGRO MATE

○  
**SWIVEL TOWEL RACK**  
TOALLERO GIRATORIO  
40X3X11 CM  
15,75X1,18X4,33 IN



**WJC226A0074003** ⑤  
MATTE STAINLESS STEEL / INOX MATE



**WJC226A0074002** ⑤  
GLOSSY STAINLESS STEEL / INOX BRILLO



**WJC226A0074036**  
MATTE BLACK / NEGRO MATE



O  
TOWEL RING  
TOALLERO ARO  
20X3X12 CM  
7,87X1,18X4,72 IN



WJC226A0072003 S  
MATTE STAINLESS STEEL / INOX MATE



WJC226A0072002 S  
GLOSSY STAINLESS STEEL / INOX BRILLO



WJC226A0072036 S  
MATTE BLACK / NEGRO MATE

O  
PAPER HOLDER/TOWEL  
RACK  
PORTARROLLO/TOALLERO  
15,5X3X9,5 CM  
6,1X1,18X3,74 IN



WJC226A0054003 S  
MATTE STAINLESS STEEL / INOX MATE



WJC226A0054002 S  
GLOSSY STAINLESS STEEL / INOX BRILLO



WJC226A0054036  
MATTE BLACK / NEGRO MATE

O  
PAPER HOLDER WITH COVER  
PORTARROLLO CON TAPA  
13X12,5X7 CM  
5,12X4,92X2,76 IN



WJC226A0159003  
MATTE STAINLESS STEEL / INOX MATE



WJC226A0159002  
GLOSSY STAINLESS STEEL / INOX BRILLO



WJC226A0159036  
MATTE BLACK / NEGRO MATE

O  
PAPER HOLDER WITH COVER  
PORTARROLLO CON TAPA  
13X13,5X6 CM  
5,12X5,31X2,36 IN



WJC226A0059003  
MATTE STAINLESS STEEL / INOX MATE



WJC226A0059002  
GLOSSY STAINLESS STEEL / INOX BRILLO



WJC226A0059036 S  
MATTE BLACK / NEGRO MATE

O  
PAPER HOLDER WITHOUT  
COVER  
PORTARROLLO SIN TAPA  
3X12,5X3 CM  
1,18X4,92X1,18 IN



WJC226A0158003 S  
MATTE STAINLESS STEEL / INOX MATE



WJC226A0158002 S  
GLOSSY STAINLESS STEEL / INOX BRILLO



WJC226A0158036 S  
MATTE BLACK / NEGRO MATE





○  
PAPER HOLDER WITHOUT COVER

PORTARROLLO SIN TAPA

1,6X13X1,6 CM  
0,63X5,12X0,63 IN



WJC226A0058003   
MATTE STAINLESS STEEL / INOX MATE

WJC226A0058002   
GLOSSY STAINLESS STEEL / INOX BRILLO

WJC226A0058036   
MATTE BLACK / NEGRO MATE

○  
PAPER HOLDER WITHOUT COVER

PORTARROLLO SIN TAPA

18,2X8X1,6 CM  
7,17X3,15X0,63 IN



WJC226A0056003   
MATTE STAINLESS STEEL / INOX MATE

WJC226A0056002   
GLOSSY STAINLESS STEEL / INOX BRILLO

WJC226A0056036   
MATTE BLACK / NEGRO MATE

○  
DOUBLE PAPER HOLDER WITHOUT COVER

PORTARROLLO DOBLE SIN TAPA

29X8X1,6 CM  
11,42X3,15X0,63 IN



WJC226A0057003   
MATTE STAINLESS STEEL / INOX MATE

WJC226A0057002   
GLOSSY STAINLESS STEEL / INOX BRILLO

WJC226A0057036   
MATTE BLACK / NEGRO MATE



O  
FREE STANDING TOILET  
BRUSH

ESCOBILLERO SUELO

9,2X9,2X38,6 CM  
3,62X3,62X15,2 IN



WJC226A0001003 S  
MATTE STAINLESS STEEL / INOX MATE



WJC226A0001002 S  
GLOSSY STAINLESS STEEL / INOX BRILLO



WJC226A0001036 S  
MATTE BLACK / NEGRO MATE

O  
WALL TOILET BRUSH  
HOLDER

ESCOBILLERO PARED

9,2X9,4X38,6 CM  
3,62X3,7X15,2 IN



WJC226A0097003 S  
MATTE STAINLESS STEEL / INOX MATE



WJC226A0097002 S  
GLOSSY STAINLESS STEEL / INOX BRILLO



WJC226A0097036 S  
MATTE BLACK / NEGRO MATE

OΔ  
FREE-STANDING OR WALL  
TOILET BRUSH

ESCOBILLERO SUELO/PARED

13,7X13,7X35,3 CM  
5,39X5,39X13,9 IN



NEW WJC292A0000001  
CHROME / CROMO



NEW WJC292A00000036  
MATTE BLACK / NEGRO MATE



# Metric

Design by **Cosmic Studio**





# Metric

Design by Cosmic Studio





**FEATURES / CARACTERÍSTICAS**

Easy installation: double pitch screw.  
Hidden attachments. Anti-corrosion.

Fácil instalación: tornillo de doble paso.  
Fijaciones ocultas. Anticorrosión.



**BLACK EDITION / BLACK EDITION**

Cosmic brings to light a new and totally innovative finish in the bathroom sector. Black Edition is an extra-matt black finish, the result of a process widely used in the automotive sector, electrophoresis. This process provides a high resistance to scratches, uniformity in the finish and a soft and pleasant texture to the touch.

This option not only allows you to give your bathroom an elegant and trendy style, but also ensures excellent quality in each piece.

Cosmic saca a la luz un nuevo acabado totalmente innovador en el sector del baño. Black Edition es un acabado negro extra-mate, resultado de un proceso muy utilizado en el sector automovilístico, la electroforesis. Este proceso aporta una gran resistencia a las rayaduras, uniformidad en el acabado y una textura suave y agradable al tacto.

Esta opción no solo te permite darle al baño un estilo elegante y en tendencia, si no que te asegura una excelente calidad en cada pieza.



**Metric** has successfully passed the high demanding tests of long last durability and resistance to extreme uses (static charge or impact testing) to assure long last durability of the product. All products come with 10 years warranty.

Toda la gama **Metric** ha superado con éxito exigentes tests de durabilidad y resistencia a usos extremos (cargas estáticas o test de impacto), para asegurar una larga vida al producto. Todos los artículos tienen 10 años de garantía.

**FINISHES / ACABADOS**

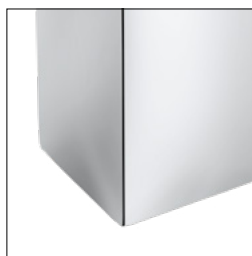

**001**  
Chrome  
Cromo



**021**  
Stainless Steel  
Inox

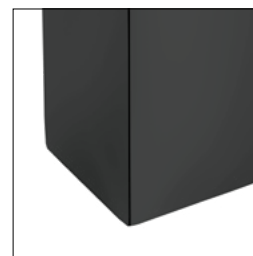

**036**  
Matte black  
Negro mate



⊙

**HOOK**  
COLGADOR  
2X4X2 CM  
0,79X1,57X0,79 IN



**WJP038A3001001**  
CHROME / CROMO



**WJP038A3001021**  
MATTE STAINLESS STEEL / INOX MATE



**WJP038A3001036**  
MATTE BLACK / NEGRO MATE

⊙

**FREE STANDING SOAP DISPENSER**  
DOSIFICADOR ENCIMERA  
5X10X20 CM  
1,97X3,94X7,87 IN

(125ML)



**WJP038A7831001**  
CHROME / CROMO



**WJP038A7831021**  
MATTE STAINLESS STEEL / INOX MATE



**WJP038A7831036**  
MATTE BLACK / NEGRO MATE

⊙

**WALL SOAP DISPENSER**  
DOSIFICADOR PARED  
5X10X20 CM  
1,97X3,94X7,87 IN

(125ML)



**WJP038A7801001**  
CHROME / CROMO



**WJP038A7801021**  
MATTE STAINLESS STEEL / INOX MATE



**WJP038A7801036**  
MATTE BLACK / NEGRO MATE



⊙  
**FREE STANDING  
BRUSH-HOLDER**  
PORTACEPILLOS ENCIMERA  
7X7X11 CM  
2,76X2,76X4,33 IN



**WJP038A7050001**  
CHROME / CROMO



**WJP038A7050021**  
MATTE STAINLESS STEEL / INOX MATE

⊙  
**WALL TOOTHBRUSH HOLDER**  
PORTACEPILLOS PARED  
8X7X11 CM  
3,15X2,76X4,33 IN



**WJP038A7001001**  
CHROME / CROMO



**WJP038A7001021**  
MATTE STAINLESS STEEL / INOX MATE

⊙  
**SHOWER SOAP DISH**  
JABONERA DE DUCHA  
22X12X6 CM  
8,66X4,72X2,36 IN



**WJP038A6010001**  
CHROME / CROMO



**WJP038A6010036**  
MATTE BLACK / NEGRO MATE

⊙  
**SHOWER SOAP DISH**  
JABONERA DE DUCHA  
34X12X6 CM  
13,39X4,72X2,36 IN



**WJP038A6020001**  
CHROME / CROMO



**WJP038A6020021**  
MATTE STAINLESS STEEL / INOX MATE

⊙  
**TOWEL RACK**  
TOALLERO  
22X7X2 CM  
8,66X2,76X0,79 IN



**WJP038A1481001**  
CHROME / CROMO



**WJP038A1481021**  
MATTE STAINLESS STEEL / INOX MATE



⊙  
TOWEL RACK  
TOALLERO  
30X7X2 CM  
11,81X2,76X0,79 IN



WJP038A1030001  
CHROME / CROMO



WJP038A1030036  
MATTE BLACK / NEGRO MATE

⊙  
TOWEL RACK  
TOALLERO  
40X7X2 CM  
15,75X2,76X0,79 IN



WJP038A1040001  
CHROME / CROMO



WJP038A1040021  
MATTE STAINLESS STEEL / INOX MATE



WJP038A1040036  
MATTE BLACK / NEGRO MATE

⊙  
TOWEL RACK  
TOALLERO  
60X7X2 CM  
23,62X2,76X0,79 IN



WJP038A1060001  
CHROME / CROMO



WJP038A1060021  
MATTE STAINLESS STEEL / INOX MATE



WJP038A1060036  
MATTE BLACK / NEGRO MATE



⊙  
**DOUBLE TOWEL RACK**  
TOALLERO DOBLE

60X10X2 CM  
23,62X3,94X0,79 IN



**WJP038A1442001**  
CHROME / CROMO

⊙  
**TOWEL RING**  
TOALLERO ARO

18X7X21 CM  
7,09X2,76X8,27 IN



**WJP038A2005001**  
CHROME / CROMO



**WJP038A2005021**  
MATTE STAINLESS STEEL / INOX MATE



**WJP038A2005036**  
MATTE BLACK / NEGRO MATE

⊙  
**TOWEL RACK SHELF**  
TOALLERO ESTANTE

60X30X11 CM  
23,62X11,81X4,33 IN



**WJP038A5110001**  
CHROME / CROMO



**WJP038A5110036**  
MATTE BLACK / NEGRO MATE

⊙  
**PAPER HOLDER WITHOUT COVER**  
PORTARROLLO SIN TAPA

18X7,5X2 CM  
7,09X2,95X0,79 IN



**WJP038A4001001**  
CHROME / CROMO



**WJP038A4001021**  
MATTE STAINLESS STEEL / INOX MATE



**WJP038A4001036**  
MATTE BLACK / NEGRO MATE

⊙  
**RIGHT PAPER HOLDER WITHOUT COVER**  
PORTARROLLO SIN TAPA DERECHO

15X8X4 CM  
5,91X3,15X1,57 IN



**WJP038A4002001**  
CHROME / CROMO



**WJP038A4002021**  
MATTE STAINLESS STEEL / INOX MATE



**WJP038A4002036**  
MATTE BLACK / NEGRO MATE



⊙  
LEFT PAPER HOLDER WITH-  
OUT COVER

PORTARROLLO SIN TAPA  
IZQUIERDO

15X8X4 CM  
5,91X3,15X1,57 IN



WJP038A4010001  
CHROME / CROMO



WJP038A4010036  
MATTE BLACK / NEGRO MATE

⊙  
VERTICAL PAPER HOLDER  
PORTARROLLO VERTICAL

4X9X17 CM  
1,57X3,54X6,69 IN



WJP038A4042001  
CHROME / CROMO



WJP038A4042021  
MATTE STAINLESS STEEL / INOX MATE



WJP038A4042036  
MATTE BLACK / NEGRO MATE

⊙ ⊙  
FREE STANDING TOILET  
BRUSH

ESCOBILLERO SUELO

8X8X57,2 CM  
3,15X3,15X22,52 IN



WJP038A9050001  
CHROME / CROMO



WJP038A9050021  
MATTE STAINLESS STEEL / INOX MATE



WJP038A9050036  
MATTE BLACK / NEGRO MATE

⊙ ⊙  
WALL TOILET BRUSH  
HOLDER

ESCOBILLERO PARED

8X10X57,2 CM  
3,15X3,94X22,52 IN



WJP038A9001001  
CHROME / CROMO



WJP038A9001021  
MATTE STAINLESS STEEL / INOX MATE



WJP038A9001036  
MATTE BLACK / NEGRO MATE





# Micra

Design by Cosmic Studio





# Micra

Design by Cosmic Studio





#### FEATURES / CARACTERÍSTICAS

Easy installation: double pitch screw.  
Hidden attachments. Anti-corrosion.

Fácil instalación: tornillo de doble paso.  
Fijaciones ocultas. Anticorrosión.

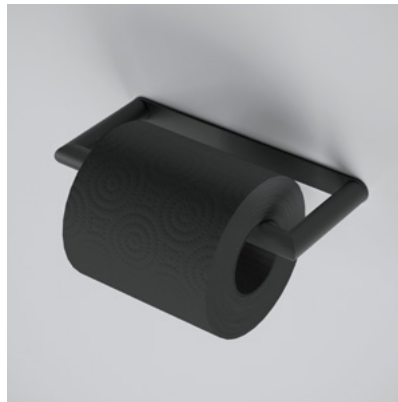

#### BLACK EDITION / BLACK EDITION

Cosmic brings to light a new and totally innovative finish in the bathroom sector. Black Edition is an extra-matt black finish, the result of a process widely used in the automotive sector, electrophoresis. This process provides a high resistance to scratches, uniformity in the finish and a soft and pleasant texture to the touch.

This option not only allows you to give your bathroom an elegant and trendy style, but also ensures excellent quality in each piece.

Cosmic saca a la luz un nuevo acabado totalmente innovador en el sector del baño. Black Edition es un acabado negro extra-mate, resultado de un proceso muy utilizado en el sector automovilístico, la electroforesis. Este proceso aporta una gran resistencia a las rayaduras, uniformidad en el acabado y una textura suave y agradable al tacto.

Esta opción no solo te permite darle al baño un estilo elegante y en tendencia, si no que te asegura una excelente calidad en cada pieza.



Micra has successfully passed the high demanding tests of long last durability and resistance to extreme uses (static charge or impact testing) to assure long last durability of the product. All products come with 10 years warranty, except for waste bins and stools, which come with 3 years warranty.

Toda la gama Micra ha superado con éxito exigentes tests de durabilidad y resistencia a usos extremos (cargas estáticas o test de impacto), para asegurar una larga vida al producto. Todos los artículos tienen 10 años de garantía a excepción de las papeleras y los taburetes que tienen una garantía de 3 años.

#### FINISHES / ACABADOS



001  
Chrome  
Cromo



036  
Matte black  
Negro mate



# Micra

Design by Cosmic Studio

AxBxC CM  
INCH AxBxC





**HOOK**

COLGADOR

1,5X5X2 CM  
0,59X1,97X0,79 IN



**WJP047A3001001**  
CHROME / CROMO



**WJP047A3001036**  
MATTE BLACK / NEGRO MATE



**HOOK**

COLGADOR

1,6X9X14 CM  
0,63X3,54X5,51 IN



**WJP047A3003001**  
CHROME / CROMO



**DOUBLE TOWEL RACK/HOOK**

TOALLERO DOBLE/COLGADOR

50X13X8 CM  
19,69X5,12X3,15 IN



**WJP047A1443001**  
CHROME / CROMO



**DOUBLE HOOK**

COLGADOR DOBLE

8X5X2 CM  
3,15X1,97X0,79 IN



**WJP047A3002001**  
CHROME / CROMO



**FREE STANDING SOAP DISPENSER**

DOSIFICADOR ENCIMERA

6X8,5X21,7 CM  
2,36X3,35X8,54 IN

(250ML)



**WJP047A7832001**  
CHROME / CROMO



**WJP047A7832036**  
MATTE BLACK / NEGRO MATE



⊙ ○  
**WALL SOAP DISPENSER**  
DOSIFICADOR PARED  
6X10X21,7 CM  
2,36X3,94X8,54 IN



**WJP047A7802001**  
CHROME / CROMO



**WJP047A7802036**  
MATTE BLACK / NEGRO MATE

(250ML)

⊙ ⊛  
**FREE STANDING  
BRUSH-HOLDER**  
PORTACEPILLOS ENCIMERA  
7X7X16 CM  
2,76X2,76X6,3 IN



**WJP047A7050001**  
CHROME / CROMO

⊙  
**WALL TOOTHBRUSH HOLDER**  
PORTACEPILLOS PARED  
7X10X16 CM  
2,76X3,94X6,3 IN



**WJP047A7001001**  
CHROME / CROMO



⊙  
FREE STANDING SOAP DISH  
JABONERA ENCIMERA

14X12X1,5 CM  
5,51X4,72X0,59 IN



WJP047A6050001  
CHROME / CROMO

⊙ ⊕  
SHOWER SOAP DISH  
JABONERA DE DUCHA

30X12,5X9 CM  
11,81X4,92X3,54 IN



WJP047A6020001  
CHROME / CROMO



WJP047A6020036  
MATTE BLACK / NEGRO MATE

⊙ ⊕  
SHELF  
ESTANTE

40X12,6X1,5 CM  
15,75X4,96X0,59 IN



WJP047A5040001  
CHROME / CROMO

⊙  
TOWEL RACK  
TOALLERO

30X7X1,5 CM  
11,81X2,76X0,59 IN



WJP047A1030001  
CHROME / CROMO



WJP047A1030036  
MATTE BLACK / NEGRO MATE

⊙  
TOWEL RACK  
TOALLERO

40X7X1,5 CM  
15,75X2,76X0,59 IN



WJP047A1040001  
CHROME / CROMO



WJP047A1040036  
MATTE BLACK / NEGRO MATE



⊙  
**TOWEL RACK**  
TOALLERO  
50X7X1,5 CM  
19,69X2,76X0,59 IN



**WJP047A1050001**  
CHROME / CROMO



**WJP047A1050036**  
MATTE BLACK / NEGRO MATE

⊙  
**DOUBLE LATERAL TOWEL RACK**  
TOALLERO LATERAL DOBLE  
1,5X37X11 CM  
0,59X14,57X4,33 IN



**WJP047A1401001**  
CHROME / CROMO

⊙  
**TOWEL RING**  
TOALLERO ARO  
23X6X11 CM  
9,06X2,36X4,33 IN



**WJP047A2055001**  
CHROME / CROMO



**WJP047A2055036**  
MATTE BLACK / NEGRO MATE

⊙  
**TOWEL RACK SHELF**  
TOALLERO ESTANTE  
50X25X8,7 CM  
19,69X9,84X3,43 IN



**WJP047A5110002**  
CHROME / CROMO

⊙  
**PAPER HOLDER WITHOUT COVER**  
PORTARROLLO SIN TAPA  
16,5X7X1,5 CM  
6,5X2,76X0,59 IN



**WJP047A4002001**  
CHROME / CROMO



**WJP047A4002036**  
MATTE BLACK / NEGRO MATE



⊙  
RIGHT PAPER HOLDER WITH-  
OUT COVER

PORTARROLLO SIN TAPA  
DERECHO

16X7X4,5 CM  
6,3X2,76X1,77 IN



WJP047A4001001  
CHROME / CROMO



WJP047A4001036  
MATTE BLACK / NEGRO MATE

⊙  
LEFT PAPER HOLDER WITH-  
OUT COVER

PORTARROLLO SIN TAPA  
IZQUIERDO

16X7X4,5 CM  
6,3X2,76X1,77 IN



WJP047A4010001  
CHROME / CROMO



WJP047A4010036  
MATTE BLACK / NEGRO MATE

⊙○  
FREE STANDING TOILET  
BRUSH

ESCOBILLERO SUELO

9X9X50 CM  
3,54X3,54X19,69 IN



WJP047A9050001  
CHROME / CROMO



WJP047A9050036  
MATTE BLACK / NEGRO MATE

⊙○  
WALL TOILET BRUSH  
HOLDER

ESCOBILLERO PARED

6X8X50 CM  
2,36X3,15X19,69 IN



WJP047A9001001  
CHROME / CROMO



WJP047A9001036  
MATTE BLACK / NEGRO MATE



# Next

Design by **Cosmic Studio**







Easy installation  
without drilling

Bonded with  
high adhesion  
adhesive

Quick, easy, silent  
installation

Static load  
of 5 kg

Do not use on  
painted surfaces  
and gypsum walls

Fácil instalación  
sin taladro

Fijación con  
adhesivo de alta  
adherencia

Montaje sin ruido,  
fácil y rápido

Carga estática  
de 5 KG

No usar en  
superficies pintadas  
ni en paredes rugosas

**QUICK  
FIX**





Next has successfully passed the high demanding tests of long last durability and resistance to extreme uses (static charge or impact testing) to assure long last durability of the product. All products come with 10 years warranty.

Toda la gama Next ha superado con éxito exigentes tests de durabilidad y resistencia a usos extremos (cargas estáticas o test de impacto), para asegurar una larga vida al producto. Todos los artículos tienen 10 años de garantía

Next emerged with the aim of taking design to any type of bathroom. Created with people in mind, it offers a dual fixing system with an efficient double-sided adhesive. This is in addition to two different finishes (Chrome and Soft Black), allowing it to fit in with all kinds of styles. Next is a functional collection with a designer touch that will suit all budgets.

Next nace con el objetivo de poder llevar diseño a cualquier tipo de baño. Diseñada pensando en las personas, ofrece un sistema de fijación Dual con un eficiente adhesivo de doble cara. Y dos acabados diferentes, cromado y negro Soft, para encajar en todo tipo de estilos. Una colección funcional con un toque de diseño para todo tipo de presupuestos.

#### FINISHES / ACABADOS



001  
Chrome  
Cromo

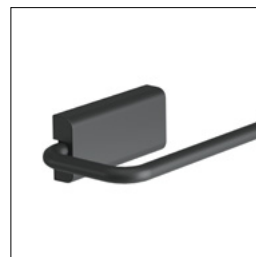

036  
Black matt  
Negro mate

## Soft Black

Cosmic has developed a new Soft Black finish for Next with an extra matte texture

Cosmic ha desarrollado para Next un nuevo acabado Soft Black, que destaca por ser extra mate

From automotive engineering to your bathroom

Desde la ingeniería automotriz hasta tu baño

Highly scratch resistant

Muy resistente a los rasguños

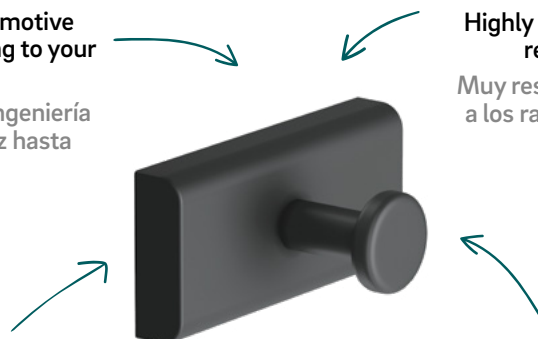

Strong and long-lasting  
Resistente y duradero

Uniform and compact black coating  
Recubrimiento negro compacto y uniforme



⊙△  
**HOOK**  
COLGADOR  
7,2X3,6X3,3 CM  
2,83X1,42X1,3 IN



WJC215A0021001  
CHROME / CROMO

WJC215A0021036  
MATTE BLACK / NEGRO MATE

DUAL QUICKFIX

⊙△  
**DOUBLE HOOK**  
COLGADOR DOBLE  
14,1X3,6X3,3 CM  
5,55X1,42X1,3 IN



WJC215A0022001  
CHROME / CROMO

WJC215A0022036  
MATTE BLACK / NEGRO MATE

DUAL QUICKFIX

⊙△○  
**FREE STANDING SOAP DISPENSER**  
DOSIFICADOR ENCIMERA  
6,2X8,1X14,6 CM  
2,44X3,19X5,75 IN



WJC215A0004001  
CHROME / CROMO

WJC215A0004036  
MATTE BLACK / NEGRO MATE

(200ML)

⊙△○  
**WALL SOAP DISPENSER**  
DOSIFICADOR PARED  
6,2X8,7X14,5 CM  
2,44X3,43X5,71 IN



WJC215A0005001  
CHROME / CROMO

WJC215A0005036  
MATTE BLACK / NEGRO MATE

DUAL QUICKFIX  
(200ML)

⊙  
**FREE STANDING BRUSH HOLDER**  
PORTACEPILLOS ENCIMERA  
6,2X6,2X12 CM  
2,44X2,44X4,72 IN



WJC215A0053001  
CHROME / CROMO

WJC215A0053036  
MATTE BLACK / NEGRO MATE

⊙  
**WALL TOOTH-BRUSH HOLDER**  
PORTACEPILLOS PARED  
6,2X6,8X12 CM  
2,44X2,68X4,72 IN



WJC215A0052001  
CHROME / CROMO

WJC215A0052036  
MATTE BLACK / NEGRO MATE

DUAL QUICKFIX

△○  
**TOWEL RACK**  
TOALLERO  
30,8X6,5X3,3 CM  
12,13X2,56X1,3 IN



WJC215A0063001  
CHROME / CROMO

WJC215A0063036  
MATTE BLACK / NEGRO MATE

DUAL QUICKFIX

△○  
**TOWEL RACK**  
TOALLERO  
40,8X6,5X3,3 CM  
16,06X2,56X1,3 IN



WJC215A0064001  
CHROME / CROMO

WJC215A0064036  
MATTE BLACK / NEGRO MATE

DUAL QUICKFIX



△○  
TOWEL RACK  
TOALLERO  
60,8X6,5X3,3 CM  
23,94X2,56X1,3 IN



DUAL QUICKFIX

WJC215A0065001  
CHROME / CROMO

WJC215A0065036  
MATTE BLACK / NEGRO MATE

⊙○  
SWIVEL DOUBLE  
TOWEL RACK  
TOALLERO DOBLE  
GIRATORIO  
36,7X3,9X7,2 CM  
14,45X1,54X2,83 IN



DUAL QUICKFIX

WJC215A0075001  
CHROME / CROMO

WJC215A0075036  
MATTE BLACK / NEGRO MATE

△○  
TOWEL RING  
TOALLERO ARO  
20,8X6,7X7,7 CM  
8,19X2,64X3,03 IN



DUAL QUICKFIX

WJC215A0071001  
CHROME / CROMO

WJC215A0071036  
MATTE BLACK / NEGRO MATE

△○  
TOWEL RACK  
SHELF  
TOALLERO ES-  
TANTE  
54,1X21,4X7,2 CM  
21,3X8,43X2,83 IN



DUAL QUICKFIX

WJC215A0068001  
CHROME / CROMO

WJC215A0068036  
MATTE BLACK / NEGRO MATE

△○  
PAPER HOLDER  
WITH COVER  
PORTARROLLO CON  
TAPA  
13X8,1X7,6 CM  
5,12X3,19X2,99 IN



DUAL QUICKFIX

WJC215A0059001  
CHROME / CROMO

WJC215A0059036  
MATTE BLACK / NEGRO MATE

△○  
PAPER HOLDER  
WITHOUT COVER  
PORTARROLLO SIN  
TAPA  
13,1X5,9X6,1 CM  
5,16X2,32X2,4 IN



DUAL QUICKFIX

WJC215A0058001  
CHROME / CROMO

WJC215A0058036  
MATTE BLACK / NEGRO MATE

△○  
SPARE PAPER  
HOLDER  
PORTARROLLO  
RESERVA  
7,2X13,4X3,3 CM  
2,83X5,28X1,3 IN



DUAL QUICKFIX

WJC215A0096001  
CHROME / CROMO

WJC215A0096036  
MATTE BLACK / NEGRO MATE

△○△  
FREE STANDING  
TOILET BRUSH  
ESCOBILLERO  
SUELO  
8X8X39,4 CM  
3,15X3,15X15,51 IN



WJC215A0001001  
CHROME / CROMO

WJC215A0001036  
MATTE BLACK / NEGRO MATE

△○△  
WALL TOILET  
BRUSH HOLDER  
ESCOBILLERO  
PARED  
8X8,8X39,4 CM  
3,15X3,46X15,51 IN



DUAL QUICKFIX

WJC215A0000001  
CHROME / CROMO

WJC215A0000036  
MATTE BLACK / NEGRO MATE



Next



# Start

Design by **Cosmic Studio**

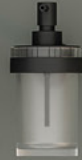



# Start

Design by Cosmic Studio





**Start** has successfully passed the high demanding tests of long last durability and resistance to extreme uses (static charge or impact testing) to assure long last durability of the product. All products come with 10 years warranty.

Toda la gama **Start** ha superado con éxito exigentes tests de durabilidad y resistencia a usos extremos (cargas estáticas o test de impacto), para asegurar una larga vida al producto. Todos los artículos tienen 10 años de garantía

**Start** is designed for people who appreciate simplicity in design. Each piece in this collection has a smooth, stylish shape that masterfully combines with a variety of modern settings. This is a full range of bathroom accessories comprising shower caddies with a removable tray, available in two finishes, chrome and matte black.

**Start** está diseñada para personas que aprecian la simplicidad en el diseño. Cada pieza de esta colección tiene una forma suave y elegante que combina a la perfección con una variedad de ambientes contemporáneos. Colección completa de accesorios para el baño que integra jaboneras de ducha con bandeja extraíble, disponible en dos acabados cromo y negro mate.

**FINISHES / ACABADOS**



**001**  
Chrome  
Cromo



**036**  
Black matt  
Negro mate

## Soft Black

**Cosmic has developed a new Soft Black finish for Start with an extra matte texture**

**Cosmic ha desarrollado para Start un nuevo acabado Soft Black, que destaca por ser extra mate**

From automotive engineering to your bathroom

Desde la ingeniería automotriz hasta tu baño

Strong and long-lasting  
Resistente y duradero

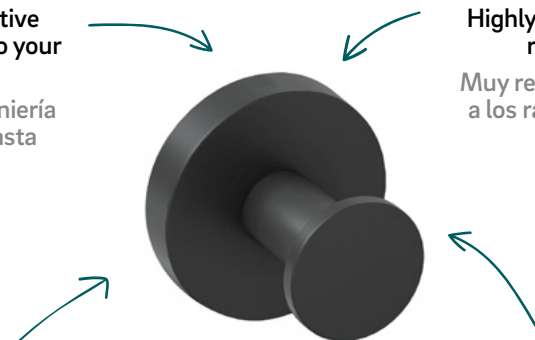

Highly scratch resistant

Muy resistente a los rasguños

Uniform and compact black coating  
Recubrimiento negro compacto y uniforme





**HOOK**  
COLGADOR  
5X4,3X5 CM  
1,97X1,69X1,97 IN



WJC419A0021001  
CHROME / CROMO

WJC419A0021036  
MATTE BLACK / NEGRO MATE



**DOUBLE HOOK**  
COLGADOR DOBLE  
6,5X4,3X5 CM  
2,56X1,69X1,97 IN



WJC419A0022001  
CHROME / CROMO

WJC419A0022036  
MATTE BLACK / NEGRO MATE



**FREE STANDING SOAP DISPENSER**  
DOSIFICADOR  
ENCIMERA  
6,2X8,1X14,6 CM  
2,44X3,19X5,75 IN



WJC215A0004001  
CHROME / CROMO

WJC215A0004036  
MATTE BLACK / NEGRO MATE



**FREE STANDING SOAP DISPENSER**  
DOSIFICADOR  
ENCIMERA  
6X8,5X16,5 CM  
2,36X3,35X6,5 IN



(200ML)

WJC226A0053002 **S**  
GLOSSY STAINLESS STEEL / INOX BRILLO

WJC226A0053036 **S**  
MATTE BLACK / NEGRO MATE



**WALL SOAP DISPENSER**  
DOSIFICADOR  
PARED  
6X11X16,5 CM  
2,36X4,33X6,5 IN



(200ML)

WJC226A0004002 **S**  
GLOSSY STAINLESS STEEL / INOX BRILLO

WJC226A0004036 **S**  
MATTE BLACK / NEGRO MATE



**WALL SOAP DISPENSER**  
DOSIFICADOR  
PARED  
7,6X12,5X15,8 CM  
2,99X4,92X6,22 IN



(200ML)

WJC419A0005001  
CHROME / CROMO

WJC419A0005036  
MATTE BLACK / NEGRO MATE



**WALL SOAP DISPENSER**  
DOSIFICADOR  
PARED  
6,2X8,7X14,5 CM  
2,44X3,43X5,71 IN



DUAL QUICKFIX  
(200ML)

WJC215A0005001  
CHROME / CROMO

WJC215A0005036  
MATTE BLACK / NEGRO MATE



**FREE STANDING BRUSH HOLDER**  
PORTACEPILLOS  
ENCIMERA  
6,2X6,2X12 CM  
2,44X2,44X4,72 IN



WJC215A0053001  
CHROME / CROMO

WJC215A0053036  
MATTE BLACK / NEGRO MATE



**FREE STANDING BRUSH HOLDER**  
PORTACEPILLOS  
ENCIMERA  
6X6X14 CM  
2,36X2,36X5,51 IN



WJC226A0051002  
GLOSSY STAINLESS STEEL / INOX BRILLO

WJC226A0051036  
MATTE BLACK / NEGRO MATE



**WALL TOOTH-BRUSH HOLDER**  
PORTACEPILLOS  
PARED  
7,6X11,3X12 CM  
2,99X4,45X4,72 IN



WJC419A0052001  
CHROME / CROMO

WJC419A0052036  
MATTE BLACK / NEGRO MATE



S ALTA DISPONIBILIDAD.  
HIGH AVAILABILITY.



# Start

Design by **Cosmic Studio**

AxBxC CM  
INCH AxBxC



⊙  
**WALL TOOTHBRUSH HOLDER**  
PORTACEPILLOS PARED

6,2X6,8X12 CM  
2,44X2,68X4,72 IN

DUAL QUICKFIX



**WJC215A0052001**  
CHROME / CROMO



**WJC215A0052036**  
MATTE BLACK / NEGRO MATE

○△  
**WALL TOOTHBRUSH HOLDER**  
PORTACEPILLOS PARED

6X9X14 CM  
2,36X3,54X5,51 IN

**WJC226A0003002** **S**  
GLOSSY STAINLESS STEEL / INOX BRILLO



**WJC226A0003036** **S**  
MATTE BLACK / NEGRO MATE



⊙◇  
**WALL SOAP DISH**  
JABONERA PARED

11X13X5 CM  
4,33X5,12X1,97 IN



**WJC419A0032001**  
CHROME / CROMO



**WJC419A0032036**  
MATTE BLACK / NEGRO MATE

⊙  
**SHOWER SOAP DISH**  
JABONERA DE DUCHA

20X11,5X5 CM  
7,87X4,53X1,97 IN



**WJC419A0030001**  
CHROME / CROMO



**WJC419A0030036**  
MATTE BLACK / NEGRO MATE

○△  
**SHOWER SOAP DISH**  
JABONERA DE DUCHA

30X10,6X8 CM  
11,81X4,17X3,35 IN

DUAL QUICKFIX

FÁCIL EXTRACCIÓN PARA SU LIMPIEZA. JABONERA EXTRAIBLE



**WJB269A0049001**  
CHROME / CROMO



**WJC419A0049036**  
MATTE BLACK / NEGRO MATE

○△  
**CORNER SHOWER BASKET**  
JABONERA DE DUCHA RINCÓN

21,7X21,9X8 CM  
8,54X8,62X3,15 IN

DUAL QUICKFIX

FÁCIL EXTRACCIÓN PARA SU LIMPIEZA. JABONERA EXTRAIBLE



**WJB269A0050001**  
CHROME / CROMO



**WJC419A0050036**  
MATTE BLACK / NEGRO MATE

◆⊙  
**SHELF**  
ESTANTE

40X10,8X5 CM  
15,75X4,25X1,97 IN



**WJC419A0044001**  
CHROME / CROMO



**WJC419A0044036**  
MATTE BLACK / NEGRO MATE

⊙  
**TOWEL RACK**  
TOALLERO

40X7X5 CM  
15,75X2,76X1,97 IN



**WJC419A0064001**  
CHROME / CROMO



**WJC419A0064036**  
MATTE BLACK / NEGRO MATE

⊙  
**TOWEL RACK**  
TOALLERO

60X7X5 CM  
23,62X2,76X1,97 IN



**WJC419A0065001**  
CHROME / CROMO



**WJC419A0065036**  
MATTE BLACK / NEGRO MATE

○⊙  
**TOWEL RING**  
TOALLERO ARO

20X5,7X20 CM  
7,87X2,24X7,87 IN



**WJC419A0072001**  
CHROME / CROMO



**WJC419A0072036**  
MATTE BLACK / NEGRO MATE



⊙⊙  
TOWEL RACK  
SHELF  
TOALLERO  
ESTANTE  
62X20X13,5 CM  
24,41X7,87X5,31 IN



WJC419A0068001  
CHROME / CROMO

WJC419A0068036  
MATTE BLACK / NEGRO MATE

⊙⊙  
PAPER HOLDER  
WITH COVER  
PORTARROLLO CON  
TAPA  
12,5X5,7X8,6 CM  
4,92X2,24X3,39 IN



WJC419A0059001  
CHROME / CROMO

WJC419A0059036  
MATTE BLACK / NEGRO MATE

⊙  
LEFT PAPER  
HOLDER WITHOUT  
COVER  
PORTARROLLO SIN  
TAPA DERECHO  
17X8,2X5 CM  
6,69X3,23X1,97 IN



WJC419A0056001  
CHROME / CROMO

WJC419A0056036  
MATTE BLACK / NEGRO MATE

⊙  
DOUBLE PAPER  
HOLDER  
PORTARROLLO  
DOBLE  
29X8X5 CM  
11,42X3,15X1,97 IN



WJC419A0055001  
CHROME / CROMO

WJC419A0055036  
MATTE BLACK / NEGRO MATE

⊙  
VERTICAL PAPER  
HOLDER  
PORTARROLLO  
VERTICAL  
6X9X17 CM  
2,36X3,54X6,69 IN



WJC419A0058001  
CHROME / CROMO

WJC419A0058036  
MATTE BLACK / NEGRO MATE

○  
FREE STANDING  
TOILET BRUSH  
ESCOBILLERO  
SUELO  
9,2X9,2X38,6 CM  
3,62X3,62X15,2 IN



WJC226A0001002 **S**  
GLOSSY STAINLESS STEEL / INOX BRILLO

WJC226A0001036 **S**  
MATTE BLACK / NEGRO MATE

△○△  
FREE STANDING  
TOILET BRUSH  
ESCOBILLERO  
SUELO  
8X8X39,4 CM  
3,15X3,15X15,51 IN



WJC215A0001001  
CHROME / CROMO

WJC215A0001036  
MATTE BLACK / NEGRO MATE

⊙◇  
WALL TOILET  
BRUSH HOLDER  
ESCOBILLERO  
PARED  
7,6X11,3X38,3 CM  
2,99X4,45X15,08 IN



WJC419A0000001  
CHROME / CROMO

WJC419A0000036  
MATTE BLACK / NEGRO MATE

○  
WALL TOILET  
BRUSH HOLDER  
ESCOBILLERO  
PARED  
9,2X9,2X38,6 CM  
3,62X3,62X15,2 IN



WJC226A0097002 **S**  
GLOSSY STAINLESS STEEL / INOX BRILLO

WJC226A0097036 **S**  
MATTE BLACK / NEGRO MATE

△○△  
WALL TOILET  
BRUSH HOLDER  
ESCOBILLERO  
PARED  
8X8,8X39,4 CM  
3,15X3,46X15,51 IN



WJC215A0000001  
CHROME / CROMO

WJC215A0000036  
MATTE BLACK / NEGRO MATE

DUAL QUICKFIX



WASTE BIN  
PAPELERA

17,2X23,8X26,8 CM  
6,77X9,37X10,55 IN

(3L)



WJC292A0002036  
MATTE BLACK / NEGRO MATE



# Stick

Design by **Valentí García**









**QUICK FIX / QUICK FIX**

Quick Fix adhesive, designed exclusively for our firm, means that bathroom accessories can be installed without drilling holes in the wall.

Con el adhesivo Quick Fix, elaborado en exclusiva para la firma, se facilita el montaje sin la necesidad de hacer agujeros en la pared.



**FEATURES / CARACTERÍSTICAS**

Easy installation: double pitch screw. Hidden attachments. Anti-corrosion.

Fácil instalación: tornillo de doble paso. Fijaciones ocultas. Anticorrosión.



Stick has successfully passed the high demanding tests of long last durability and resistance to extreme uses (static charge or impact testing) to assure long last durability of the product. All products come with 10 years warranty.

Toda la gama **Stick** ha superado con éxito exigentes tests de durabilidad y resistencia a usos extremos (cargas estáticas o test de impacto), para asegurar una larga vida al producto. Todos los artículos tienen 10 años de garantía.

**FINISHES / ACABADOS**



**001**  
Chrome  
Cromo

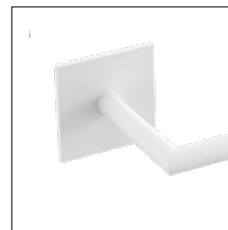

**065**  
Matte white  
Blanco mate

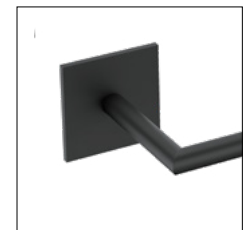

**036**  
Matte black  
Negro mate

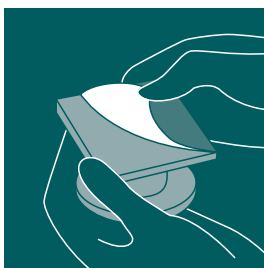

**QUICK  
FIX**



Easy installation  
without drilling

Fácil instalación  
sin taladro



Bonded with  
high adhesion  
adhesive

Fijación con  
adhesivo de alta  
adherencia



Quick, easy, silent  
installation

Montaje sin ruido,  
fácil y rápido



Static load  
of 5 kg

Carga estática  
de 5 KG



Do not use on  
painted surfaces  
and gypsum walls

No usar en  
superficies pintadas  
ni en paredes rugosas



⊙

**HOOK**  
COLGADOR  
4,5X4,4X4,5 CM  
1,77X1,73X1,77 IN



QUICKFIX

WJB276A0021001  
CHROME / CROMO

WJB276A0021065  
MATTE WHITE / BLANCO MATE

WJB276A0021036  
BLACK-MATTE / NEGRO-MATE

⊙

**HOOK**  
COLGADOR  
2,5X6,6X7 CM  
0,98X2,6X2,76 IN



WJB276A0023001  
CHROME / CROMO

WJB276A0023065  
MATTE WHITE / BLANCO MATE

WJB276A0023036  
BLACK-MATTE / NEGRO-MATE

⊙

**DOUBLE HOOK**  
COLGADOR DOBLE  
11X4,4X4,5 CM  
4,33X1,73X1,77 IN



QUICKFIX

WJB276A0022001  
CHROME / CROMO

WJB276A0022065  
MATTE WHITE / BLANCO MATE

WJB276A0022036  
BLACK-MATTE / NEGRO-MATE





◆ ◎  
WALL SOAP DISPENSER  
DOSIFICADOR PARED

7,6X11,8X16,4 CM  
2,99X4,65X6,46 IN

QUICKFIX  
(200ML)



WJB276A0003001  
CHROME / CROMO



WJB276A0003065  
MATTE WHITE / BLANCO MATE



WJB276A0003036  
BLACK-MATTE / NEGRO-MATE

◆ ◎  
WALL TOOTHBRUSH HOLDER  
PORTACEPILLOS PARED

7,6X10,8X11,6 CM  
2,99X4,25X4,57 IN

QUICKFIX



WJB276A0053001  
CHROME / CROMO



WJB276A0053065  
MATTE WHITE / BLANCO MATE



WJB276A0053036  
BLACK-MATTE / NEGRO-MATE

◎  
SHOWER SOAP DISH  
JABONERA DE DUCHA

30,4X11,8X9,6 CM  
11,97X4,65X3,78 IN

QUICKFIX



WJB276A0049001  
CHROME / CROMO



WJB276A0049065  
MATTE WHITE / BLANCO MATE

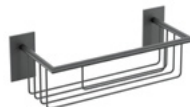

WJB276A0049036  
BLACK-MATTE / NEGRO-MATE





**GLASS SHELF**  
ESTANTE VIDRIO  
40X10,5X4,5 CM  
15,75X4,13X1,77 IN



QUICKFIX

WJB276A0044001  
CHROME / CROMO

WJB276A0044065  
MATTE WHITE / BLANCO MATE

WJB276A0044036  
BLACK-MATTE / NEGRO-MATE



**TOWEL RACK**  
TOALLERO  
30,9X4,5X8 CM  
12,17X1,77X3,15 IN



QUICKFIX

WJB276A0069001  
CHROME / CROMO

WJB276A0069065  
MATTE WHITE / BLANCO MATE

WJB276A0069036  
BLACK-MATTE / NEGRO-MATE



**TOWEL RACK**  
TOALLERO  
30X7X4,5 CM  
11,81X2,76X1,77 IN



QUICKFIX

WJB276A0063001  
CHROME / CROMO

WJB276A0063065  
MATTE WHITE / BLANCO MATE

WJB276A0063036  
BLACK-MATTE / NEGRO-MATE



**TOWEL RACK**  
TOALLERO  
45X7X4,5 CM  
17,72X2,76X1,77 IN



QUICKFIX

WJB276A0064001  
CHROME / CROMO

WJB276A0064065  
MATTE WHITE / BLANCO MATE

WJB276A0064036  
BLACK-MATTE / NEGRO-MATE



**TOWEL RACK**  
TOALLERO  
60X7X4,5 CM  
23,62X2,76X1,77 IN



QUICKFIX

WJB276A0065001  
CHROME / CROMO

WJB276A0065065  
MATTE WHITE / BLANCO MATE

WJB276A0065036  
BLACK-MATTE / NEGRO-MATE





⊙  
TOWEL RACK  
TOALLERO COLGAR MUEBLE  
27X9,5X7 CM  
10,63X3,74X2,76 IN



WJB276A0066001  
CHROME / CROMO



WJB276A0066065  
MATTE WHITE / BLANCO MATE



WJB276A0066036  
BLACK-MATTE / NEGRO-MATE

⊙  
TOWEL RACK  
TOALLERO COLGAR MUEBLE  
38X9,5X7 CM  
14,96X3,74X2,76 IN



WJB276A0067001  
CHROME / CROMO



WJB276A0067065  
MATTE WHITE / BLANCO MATE



WJB276A0067036  
BLACK-MATTE / NEGRO-MATE

⊙  
TOWEL RING  
TOALLERO ARO  
25,5X7X10 CM  
10,04X2,76X3,94 IN



WJB276A0071001  
CHROME / CROMO



WJB276A0071065  
MATTE WHITE / BLANCO MATE



WJB276A0071036  
BLACK-MATTE / NEGRO-MATE

QUICKFIX

⊙○  
PAPER HOLDER WITH COVER  
PORTARROLLO CON TAPA  
12,5X5,9X11,5 CM  
4,92X2,32X4,53 IN



WJB276A0059001  
CHROME / CROMO



WJB276A0059065  
MATTE WHITE / BLANCO MATE



WJB276A0059036  
BLACK-MATTE / NEGRO-MATE

QUICKFIX

⊙  
PAPER HOLDER WITHOUT COVER  
PORTARROLLO SIN TAPA  
4,5X14,4X4,5 CM  
1,77X5,67X1,77 IN



WJB276A0096001  
CHROME / CROMO



WJB276A0096065  
MATTE WHITE / BLANCO MATE



WJB276A0096036  
BLACK-MATTE / NEGRO-MATE

QUICKFIX





⊙  
PAPER HOLDER WITHOUT COVER

PORTARROLLO SIN TAPA

15,2X7,6X4,5 CM  
5,98X2,99X1,77 IN

QUICKFIX



WJB276A0058001  
CHROME / CROMO



WJB276A0058065  
MATTE WHITE / BLANCO MATE



WJB276A0058036  
BLACK-MATTE / NEGRO-MATE

◆ ⊙  
WALL TOILET BRUSH HOLDER

ESCOBILLERO PARED

7,6X10,7X38,3 CM  
2,99X4,21X15,08 IN

QUICKFIX



WJB276A0001001  
CHROME / CROMO



WJB276A0001065  
MATTE WHITE / BLANCO MATE



WJB276A0001036  
BLACK-MATTE / NEGRO-MATE



# The Grid

Design by Ricard Ferrer





# The Grid

Design by Ricard Ferrer

AxBxC CM  
INCH AxBxC



## FEATURES / CARACTERÍSTICAS

Hidden attachments. Anti-Corrosion.  
Lead free matte paint. Shelves & glasses  
made of acrylic glass.

Fijaciones ocultas. Anticorrosión.  
Pintura mate libre de plomo. Estantes  
y vasos fabricados en cristal acrílico.

Accessories with a ground-breaking,  
functional design. A commitment to  
innovation and modernity.

Accesorios con un diseño rompedor  
y funcional. Una apuesta por la innovación  
y la modernidad.

**The Grid** has successfully passed the high  
demanding tests of long last durability and  
resistance to extreme uses (static charge or  
impact testing) to assure long last durability  
of the product.

Toda la gama **The Grid** ha superado con éxito  
exigentes tests de durabilidad y resistencia  
a usos extremos (cargas estáticas o test de  
impacto), para asegurar una larga vida al  
producto.

## FINISHES / ACABADOS

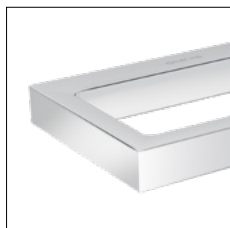

**001**  
Chrome  
Cromo

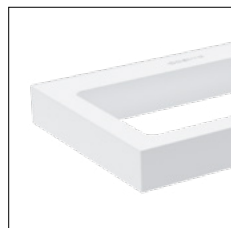

**065**  
Matte white  
Blanco mate

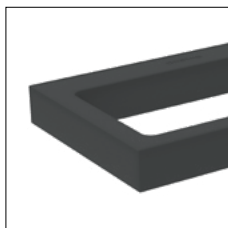

**036**  
Matte black  
Negro mate



# Accessories | Accesorios

⊙  
**HOOK**  
 COLGADOR  
 1,6X3X11 CM  
 0,63X1,18X4,33 IN



**WJC268A0021001**  
 CHROME / CROMO



**WJC268A0021065**  
 MATTE WHITE / BLANCO MATE



**WJC268A0021036**  
 MATTE BLACK / NEGRO MATE

⊙ ⊠  
**FREE-STANDING SOAP DISPENSER + BRUSH-HOLDER**  
 DOSIFICADOR + PORTACEPILLOS ENCIMERA  
 11X14,5X12,7 CM  
 4,33X5,71X5 IN



**WJC268A0004001**  
 CHROME-WHITE / CROMO-BLANCO



**WJC268A0004065**  
 MATTE WHITE / BLANCO MATE



**WJC268A0004036**  
 MATTE BLACK / NEGRO MATE

(385ML)

⊙  
**SWIVEL TOWEL RACK**  
 TOALLERO GIRATORIO  
 40,3X1,6X11 CM  
 15,87X0,63X4,33 IN



**WJC268A0074001**  
 CHROME / CROMO



**WJC268A0074065**  
 MATTE WHITE / BLANCO MATE



**WJC268A0074036**  
 MATTE BLACK / NEGRO MATE

⊙ ⊠  
**TOWEL RACK WITH SHELF**  
 TOALLERO CON REPISA  
 35X11X11 CM  
 13,78X4,33X4,33 IN



**WJC268A0063001**  
 CHROME-WHITE / CROMO-BLANCO



**WJC268A0063065**  
 MATTE WHITE / BLANCO MATE



**WJC268A0063036**  
 MATTE BLACK / NEGRO MATE

⊙ ⊠  
**TOWEL RACK WITH SHELF**  
 TOALLERO CON REPISA  
 55X11X11 CM  
 21,65X4,33X4,33 IN



**WJC268A0065001**  
 CHROME-WHITE / CROMO-BLANCO



**WJC268A0065065**  
 MATTE WHITE / BLANCO MATE



**WJC268A0065036**  
 MATTE BLACK / NEGRO MATE



# The Grid

Design by Ricard Ferrer

AxBxC CM  
INCH AxBxC



⊙  
**TOWEL RING**  
TOALLERO ARO  
20,3X1,6X11 CM  
7,99X0,63X4,33 IN



**WJC268A0071001**  
CHROME / CROMO



**WJC268A0071065**  
MATTE WHITE / BLANCO MATE



**WJC268A0071036**  
MATTE BLACK / NEGRO MATE

⊙  
**PAPER HOLDER WITH COVER**  
PORTARROLLO CON TAPA  
14X13X6,5 CM  
5,51X5,12X2,56 IN



**WJC268A0059001**  
CHROME / CROMO



**WJC268A0059065**  
MATTE WHITE / BLANCO MATE

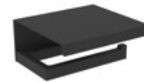

**WJC268A0059036**  
MATTE BLACK / NEGRO MATE

⊙  
**PAPER HOLDER WITHOUT COVER**  
PORTARROLLO SIN TAPA  
14X8,5X2,2 CM  
5,51X3,35X0,87 IN



**WJC268A0058001**  
CHROME / CROMO



**WJC268A0058065**  
MATTE WHITE / BLANCO MATE



**WJC268A0058036**  
MATTE BLACK / NEGRO MATE

⊙ ⚠  
**WALL TOILET BRUSH HOLDER**  
ESCOBILLERO PARED  
11X11X48 CM  
4,33X4,33X18,9 IN



**WJC268A0001001**  
CHROME-WHITE / CROMO-BLANCO



**WJC268A0001065**  
MATTE WHITE / BLANCO MATE



**WJC268A0001036**  
MATTE BLACK / NEGRO MATE

⊙ ⚠  
**FREE-STANDING OR WALL TOILET BRUSH HOLDER**  
ESCOBILLERO SUELO/PARED  
11X11X59 CM  
4,33X4,33X23,23 IN



**WJC268A0000001**  
CHROME-WHITE / CROMO-BLANCO



**WJC268A0000065**  
MATTE WHITE / BLANCO MATE



**WJC268A0000036**  
MATTE BLACK / NEGRO MATE



# Main categories

## Categorías principales





# Home fragrances



# Home fragrances

SCENTED CANDLE  
VELA AROMÁTICA



**NEW** WJC292A0109222  
SAND / SAND



**NEW** WJC292A0109403  
BLOSSOM / BLOSSOM



**NEW** WJC292A0109418  
OLIVE / OLIVE

MIKADO  
MIKADO



**NEW** WJC292A0110222  
SAND / SAND



**NEW** WJC292A0110403  
BLOSSOM / BLOSSOM



**NEW** WJC292A0110418  
OLIVE / OLIVE

HOME FRAGRANCE  
HOME FRAGRANCE



**NEW** WJC292A0111222  
SAND / SAND  
(500ML)



# Bathroom set

## Set de baño

**B** CONSULT SPECIAL CONDITIONS\*  
CONSULTAR CONDICIONES ESPECIALES\*

FREE-STANDING SOAP DISPENSER + BRUSH-HOLDER  
DOSIFICADOR + PORTACEPILLOS ENCIMERA



WJC268A0004065  
MATTE WHITE / BLANCO MATE  
(385ML)



WJC268A0004001  
CHROME-WHITE / CROMO-BLANCO  
(385ML)



WJC268A0004036  
MATTE BLACK / NEGRO MATE  
(385ML)

FREE STANDING SOAP DISPENSER  
DOSIFICADOR ENCIMERA



WJC216A0004081  
WHITE NATUR / BLANCO NATUR  
(200ML)



WJC216A0004083  
SAND NATUR / ARENA NATUR  
(200ML)



WJC216A0004082  
RUSSET NATUR / TERRACOTA TEXTURIZADO  
(200ML)



WJC216A0004080  
BLACK NATUR / NEGRO NATUR  
(200ML)



WJC252A0004025  
SOFT WHITE / BLANCO SOFT  
(300ML)



WJC252A0004027  
SOFT STONE / PIEDRA SOFT  
(300ML)



WJC252A0004028  
SOFT GRAY / GRIS SOFT  
(300ML)



WJC252A0004026  
SOFT BLACK / NEGRO SOFT  
(300ML)



WJC277A0004065  
MATTE WHITE / BLANCO MATE  
(185ML)



**NEW** WJC277A0004090  
SAND / ARENA  
(185ML)



**NEW** WJC277A0004089  
OLIVE / OLIVE  
(185ML)



**NEW** WJC277A0004088  
TERRACOTA / TERRACOTA  
(185ML)



WJC277A0004036  
MATTE BLACK / NEGRO MATE  
(185ML)



**NEW** WJC219A0004222 **B**  
SAND / SAND  
(350ML)



**NEW** WJC219A0004403 **B**  
BLOSSOM / BLOSSOM  
(350ML)



**NEW** WJC219A0004418 **B**  
OLIVE / OLIVE  
(350ML)



# Bathroom set

## Set de baño



# Bathroom set

## Set de baño

**B** CONSULT SPECIAL CONDITIONS\*  
CONSULTAR CONDICIONES ESPECIALES\*

FREE STANDING SOAP  
DISPENSER  
DOSIFICADOR ENCIMERA



**NEW** WJC213A0004420 **B**  
BLUISH GREEN / BLUISH GREEN  
(300ML)



**NEW** WJC213A0004345 **B**  
SMOKE GREY / SMOKE GREY  
(300ML)



WJC215A0004036  
MATTE BLACK / NEGRO MATE  
(200ML)



WJC215A0004001  
CHROME / CROMO  
(200ML)



WJC226A0053003 **S**  
MATTE STAINLESS STEEL / INOX MATE  
(200ML)



WJC226A0053002 **S**  
GLOSSY STAINLESS STEEL / INOX BRILLO  
(200ML)



WJC226A0053036 **S**  
MATTE BLACK / NEGRO MATE  
(200ML)



WJC205A0004001 **S**  
CHROME / CROMO  
(240 ML)



WJC205A0004003  
BRUSHED STEEL / INOX CEPILLADO  
(240 ML)



WJC205A0004065  
MATT WHITE / BLANCO MATE  
(240 ML)



WJC205A0004040  
BRUSHED GOLD PVD / ORO CEPILLADO PVD  
(240 ML)



WJC205A0004054  
BRUSHED COPPER PVD / COBRE CEPILLADO PVD  
(240 ML)



WJC205A0004055  
BRUSHED BLACK PVD / NEGRO CEPILLADO PVD  
(240 ML)



WJC205A0004036  
MATTE BLACK / NEGRO MATE  
(240 ML)



WJP047A7832001  
CHROME / CROMO  
(250ML)



WJP047A7832036  
MATTE BLACK / NEGRO MATE  
(250ML)



WJP036A7831001  
CHROME / CROMO  
(125ML)



WJP036A7831036  
MATTE BLACK / NEGRO MATE  
(125ML)



WJC251A0004001  
CHROME / CROMO  
(200ML)



WJC238A0004065  
MATTE WHITE / BLANCO MATE  
(200ML)



# Bathroom set

## Set de baño

### FREE STANDING SOAP DISPENSER DOSIFICADOR ENCIMERA



**WJC238A0004036**  
MATTE BLACK / NEGRO MATE  
(200ML)



**WJB269A0004001**  
CHROME / CROMO  
(370 ML)



**NEW NEA WJB350A0004003**  
MATTE STAINLESS STEEL / INOX MATE  
(200ML)



**NEW NEA WJB350A0004065**  
MATTE WHITE / BLANCO MATE  
(200ML)



**NEW NEA WJB350A0004036**  
MATTE BLACK / NEGRO MATE  
(200ML)



**WJP038A7831001**  
CHROME / CROMO  
(125ML)



**WJP038A7831021**  
MATTE STAINLESS STEEL / INOX MATE  
(125ML)



**WJP038A7831036**  
MATTE BLACK / NEGRO MATE  
(125ML)



**WJC253A0004001**  
CHROME-BLACK / CROMO-NEGRO  
(225ML)



**WJC229A0004001**  
CHROME / CROMO  
(275 ML)



**WJP056A7831001**  
CHROME / CROMO  
(185ML)



**WJP056A7831036**  
MATTE BLACK / NEGRO MATE  
(185ML)

### WALL SOAP DISPENSER DOSIFICADOR PARED



**NEW WJC277A0005065**  
MATTE WHITE / BLANCO MATE  
DUAL SMARTFIX



**NEW WJC277A0005090**  
SAND / ARENA  
DUAL SMARTFIX



**NEW WJC277A0005089**  
OLIVE / OLIVE  
DUAL SMARTFIX



**NEW WJC277A0005088**  
TERRACOTTA / TERRACOTA  
DUAL SMARTFIX



**NEW WJC277A0005036**  
MATTE BLACK / NEGRO MATE  
DUAL SMARTFIX



**WJC215A0005001**  
CHROME / CROMO  
DUAL QUICKFIX  
(200ML)



**WJC215A0005036**  
MATTE BLACK / NEGRO MATE  
DUAL QUICKFIX  
(200ML)



**WJC419A0005001**  
CHROME / CROMO  
(200ML)



**Bathroom set**  
**Set de baño**



# Bathroom set

## Set de baño

WALL SOAP DISPENSER  
DOSIFICADOR PARED



WJC419A0005036  
MATTE BLACK / NEGRO MATE  
(200ML)



WJB262A0005001  
CHROME / CROMO  
QUICKFIX  
(200ML)



WJB264A0005001  
CHROME / CROMO  
QUICKFIX  
(200ML)



WJB276A0003001  
CHROME / CROMO  
QUICKFIX  
(200ML)



WJB276A0003065  
MATTE WHITE / BLANCO MATE  
QUICKFIX  
(200ML)



WJB276A0003036  
BLACK-MATTE / NEGRO-MATE  
QUICKFIX  
(200ML)



WJC226A0004003 **S**  
MATTE STAINLESS STEEL / INOX MATE  
(200ML)



WJC226A0004002 **S**  
GLOSSY STAINLESS STEEL / INOX BRILLO  
(200ML)



WJC226A0004036 **S**  
MATTE BLACK / NEGRO MATE  
(200ML)



**NEW** WJC205A1003001 **S**  
CHROME / CROMO  
DUAL SMARTFIX  
(240 ML)



**NEW** WJC205A1003003  
BRUSHED STEEL / INOX CEPILLADO  
DUAL SMARTFIX  
(240 ML)



**NEW** WJC205A1003065  
MATT WHITE / BLANCO MATE  
DUAL SMARTFIX  
(240 ML)



**NEW** WJC205A1003040  
BRUSHED GOLD PVD / ORO CEPILLADO PVD  
DUAL SMARTFIX  
(240 ML)



**NEW** WJC205A1003054  
BRUSHED COPPER PVD / COBRE CEPILLADO PVD  
DUAL SMARTFIX  
(240 ML)



**NEW** WJC205A1003055  
BRUSHED BLACK PVD / NEGRO CEPILLADO PVD  
DUAL SMARTFIX  
(240 ML)



**NEW** WJC205A1003036  
MATTE BLACK / NEGRO MATE  
DUAL SMARTFIX  
(240 ML)



WJC290A0025002  
GLOSSY STAINLESS STEEL / INOX BRILLO  
(1500 ML)



WJC235A0003001  
CHROME / CROMO  
(400ML)



WJC235A0003003  
MATTE STAINLESS STEEL / INOX MATE  
(400ML)



WJC235A0003036  
MATTE BLACK / NEGRO MATE  
(400ML)



# Bathroom set

## Set de baño

WALL SOAP DISPENSER  
DOSIFICADOR PARED



WJP047A7802001  
CHROME / CROMO  
(250ML)



WJP047A7802036  
MATTE BLACK / NEGRO MATE  
(250ML)



WJC251A0005001  
CHROME / CROMO  
(200ML)



WJC238A0005065  
MATTE WHITE / BLANCO MATE  
(200ML)



WJC238A0005036  
MATTE BLACK / NEGRO MATE  
(200ML)



WJP038A7801001  
CHROME / CROMO  
(125ML)



WJP038A7801021  
MATTE STAINLESS STEEL / INOX MATE  
(125ML)



WJP038A7801036  
MATTE BLACK / NEGRO MATE  
(125ML)



WJC253A0005001  
CHROME-BLACK / CROMO-NEGRO  
(225ML)



WJC229A0005001  
CHROME / CROMO  
(275ML)

FREE STANDING BRUSH  
HOLDER  
PORTACEPILLOS ENCIMERA



WJC216A0053081  
WHITE NATUR / BLANCO NATUR



WJC216A0053083  
SAND NATUR / ARENA NATUR



WJC216A0053082  
RUSSET NATUR / TERRACOTA TEXTU-  
RIZADO



WJC216A0053080  
BLACK NATUR / NEGRO NATUR



WJC252A0052025  
SOFT WHITE / BLANCO SOFT



WJC252A0052027  
SOFT STONE / PIEDRA SOFT



WJC252A0052028  
SOFT GRAY / GRIS SOFT



WJC252A0052026  
SOFT BLACK / NEGRO SOFT



# Bathroom set

## Set de baño

**B** CONSULT SPECIAL CONDITIONS\*  
CONSULTAR CONDICIONES ESPECIALES\*

FREE STANDING BRUSH  
HOLDER  
PORTACEPILLOS ENCIMERA



WJC277A0051065  
MATTE WHITE / BLANCO MATE



**NEW** WJC277A0051090  
SAND / ARENA



**NEW** WJC277A0051089  
OLIVE / OLIVE



**NEW** WJC277A0051088  
TERRACOTTA / TERRACOTA



WJC277A0051036  
MATTE BLACK / NEGRO MATE



**NEW** WJC219A0051222 **B**  
SAND / ARENA



**NEW** WJC219A0051403 **B**  
BLOSSOM / BLOSSOM



**NEW** WJC219A0051418 **B**  
OLIVE / OLIVE



**NEW** WJC213A0051420 **B**  
BLUISH GREEN / BLUISH GREEN



**NEW** WJC213A0051345 **B**  
SMOKE GREY / SMOKE GREY



WJC215A0053001  
CHROME / CROMO



WJC215A0053036  
MATTE BLACK / NEGRO MATE



WJC226A0051003  
BRUSHED STEEL / INOX CEPILLADO



WJC226A0051002  
GLOSSY STAINLESS STEEL / INOX BRILLO



WJC226A0051036 **S**  
MATTE BLACK / NEGRO MATE



WJC205A0051001  
CHROME / CROMO



WJC205A0051065  
MATT WHITE / BLANCO MATE



WJC205A0051040  
BRUSHED GOLD PVD / ORO CEPILLADO PVD



WJC205A0051054  
BRUSHED COPPER PVD / COBRE CEPILLADO PVD



WJC205A0051055  
BRUSHED BLACK PVD / NEGRO CEPILLADO PVD



# Bathroom set

## Set de baño

FREE STANDING BRUSH  
HOLDER  
PORTACEPILLOS ENCIMERA



WJP047A7050001  
CHROME / CROMO



WJP036A7050001  
CHROME / CROMO



WJP036A7050036  
MATTE BLACK / NEGRO MATE



WJC251A0053001  
CHROME / CROMO



WJC238A0053065  
MATTE WHITE / BLANCO MATE



WJC238A0053036  
MATTE BLACK / NEGRO MATE



WJB269A0053001  
CHROME / CROMO



**NEW NEA** WJB350A0051003  
MATTE STAINLESS STEEL / INOX MATE



**NEW NEA** WJB350A0051065  
MATTE WHITE / BLANCO MATE



**NEW NEA** WJB350A0051036  
MATTE BLACK / NEGRO MATE



WJP038A7050001  
CHROME / CROMO



WJP038A7050021  
MATTE STAINLESS STEEL / INOX MATE



WJC253A0053001  
CHROME-BLACK / CROMO-NEGRO



WJC229A0051001  
CHROME / CROMO



WJP056A7050001  
CHROME / CROMO



WJP056A7050036  
MATTE BLACK / NEGRO MATE

WALL TOOTHBRUSH HOLDER  
PORTACEPILLOS PARED



**NEW** WJC277A0052065  
MATTE WHITE / BLANCO MATE  
DUAL SMARTFIX



**NEW** WJC277A0052090  
SAND / ARENA  
DUAL SMARTFIX



**NEW** WJC277A0052089  
OLIVE / OLIVE  
DUAL SMARTFIX



**NEW** WJC277A0052088  
TERRACOTTA / TERRACOTA  
DUAL SMARTFIX



# Bathroom set

## Set de baño

WALL TOOTHBRUSH HOLDER  
PORTACEPILLOS PARED



**NEW** WJC277A0052036  
MATTE BLACK / NEGRO MATE  
DUAL SMARTFIX



WJC215A0052001  
CHROME / CROMO  
DUAL QUICKFIX



WJC215A0052036  
MATTE BLACK / NEGRO MATE  
DUAL QUICKFIX



WJC419A0052001  
CHROME / CROMO



WJC419A0052036  
MATTE BLACK / NEGRO MATE



WJB262A0052001  
CHROME / CROMO  
QUICKFIX



WJB264A0052001  
CHROME / CROMO  
QUICKFIX



WJB276A0053001  
CHROME / CROMO  
QUICKFIX



WJB276A0053065  
MATTE WHITE / BLANCO MATE  
QUICKFIX



WJB276A0053036  
BLACK-MATTE / NEGRO-MATE  
QUICKFIX



WJC226A0003003  
MATTE STAINLESS STEEL / INOX MATE



WJC226A0003002 <sup>S</sup>  
GLOSSY STAINLESS STEEL / INOX BRILLO



WJC226A0003036 <sup>S</sup>  
MATTE BLACK / NEGRO MATE



WJC235A0053001  
CHROME / CROMO



WJC235A0053003  
MATTE STAINLESS STEEL / INOX MATE



WJC235A0053036  
MATTE BLACK / NEGRO MATE



**NEW** WJC205A1053001  
CHROME / CROMO  
DUAL SMARTFIX



**NEW** WJC205A1053003  
BRUSHED STEEL / INOX CEPILLADO  
DUAL SMARTFIX



**NEW** WJC205A1053065  
MATT WHITE / BLANCO MATE  
DUAL SMARTFIX



**NEW** WJC205A1053040  
BRUSHED GOLD PVD / ORO CEPILLADO PVD  
DUAL SMARTFIX



# Bathroom set

## Set de baño

WALL TOOTHBRUSH HOLDER  
PORTACEPILLOS PARED



**NEW** WJC205A1053054  
BRUSHED COPPER PVD / COBRE  
CEPILLADO PVD  
DUAL SMARTFIX



**NEW** WJC205A1053055  
BRUSHED BLACK PVD / NEGRO CEPI-  
LLADO PVD  
DUAL SMARTFIX



**NEW** WJC205A1053036  
BLACK-MATTE / NEGRO-MATE  
DUAL SMARTFIX



WJP047A7001001  
CHROME / CROMO



WJC251A0054001  
CHROME / CROMO



WJC238A0054065  
MATTE WHITE / BLANCO MATE



WJC238A0054036  
MATTE BLACK / NEGRO MATE



WJP038A7001001  
CHROME / CROMO



WJP038A7001021  
MATTE STAINLESS STEEL / INOX MATE



WJC253A0052001  
CHROME-BLACK / CROMO-NEGRO



WJC229A0052001  
CHROME / CROMO

FREE STANDING SOAP DISH  
JABONERA ENCIMERA



WJC216A0034081  
WHITE NATUR / BLANCO NATUR



WJC216A0034083  
SAND NATUR / ARENA NATUR



WJC216A0034082  
RUSSET NATUR / TERRACOTA TEXTU-  
RIZADO



WJC216A0034080  
BLACK NATUR / NEGRO NATUR



WJC252A0032025  
SOFT WHITE / BLANCO SOFT



WJC252A0032027  
SOFT STONE / PIEDRA SOFT



WJC252A0032028  
SOFT GRAY / GRIS SOFT



WJC252A0032026  
SOFT BLACK / NEGRO SOFT



# Bathroom set

## Set de baño

**B** CONSULT SPECIAL CONDITIONS\*  
CONSULTAR CONDICIONES ESPECIALES\*

### FREE STANDING SOAP DISH JABONERA ENCIMERA



WJC277A0032065  
MATTE WHITE / BLANCO MATE



**NEW** WJC277A0032090  
SAND / ARENA



**NEW** WJC277A0032089  
OLIVE / OLIVE



**NEW** WJC277A0032088  
TERRACOTTA / TERRACOTA



WJC277A0032036  
MATTE BLACK / NEGRO MATE



**NEW** WJC219A0034222 **B**  
SAND / ARENA



**NEW** WJC219A0034403 **B**  
BLOSSOM / BLOSSOM



**NEW** WJC219A0034418 **B**  
OLIVE / OLIVE



WJP047A6050001  
CHROME / CROMO



WJC251A0034001  
CHROME / CROMO

### WALL SOAP DISH JABONERA PARED



WJC419A0032001  
CHROME / CROMO



WJC419A0032036  
MATTE BLACK / NEGRO MATE



WJC251A0032001  
CHROME / CROMO



WJC253A0032001  
CHROME / CROMO



# Magnifying mirrors

## Espejos de aumento

WALL MAGNIFYING MIRROR WITH ADJUSTABLE LED LIGHT  
ESPEJO AUMENTO DE PARED CON LUZ LED REGULABLE



WJC292A0084001  
CHROME / CROMO  
(LED)(X5)(4.5W 100-240V)



WJC292A0084036  
MATTE BLACK / NEGRO MATE  
(LED)(X5)(4.5W 100-240V)



WJC292A0184001  
CHROME / CROMO  
(LED)(X5)



WJC292A0184036  
MATTE BLACK / NEGRO MATE  
(LED)(X5)

WALL MAGNIFYING MIRROR  
ESPEJO DE AUMENTO PARED



WJC292A0083001  
CHROME / CROMO  
(X5)



WJC292A0083036  
MATTE BLACK / NEGRO MATE  
(X5)



WJC235A0085001 <sup>S</sup>  
CHROME / CROMO  
(X5)



WJC235A0085003 <sup>S</sup>  
MATTE STAINLESS STEEL / INOX MATE  
(X5)



WJC235A0085065  
MATT WHITE / BLANCO MATE  
(X5)



WJC235A0085040  
BRUSHED GOLD PVD / ORO CEPILLADO PVD  
(X5)



WJC235A0085054  
BRUSHED COPPER PVD / COBRE CEPILLADO PVD  
(X5)



WJC235A0085055  
BRUSHED BLACK PVD / NEGRO CEPILLADO PVD  
(X5)



WJC235A0085036 <sup>S</sup>  
MATTE BLACK / NEGRO MATE  
(X5)



WJC238A0085065  
MATT WHITE / BLANCO MATE  
(X3)



WJC238A0085036  
MATTE BLACK / NEGRO MATE  
(X3)

FREE-STANDING MAGNIFYING MIRROR WITH ADJUSTABLE LED LIGHT  
ESPEJO AUMENTO DE ENCIMERA CON LUZ LED REGULABLE



WJC292A0087001  
CHROME / CROMO  
(LED)(X5)(3W 5V/1A) USB



WJC292A0087036  
MATTE BLACK / NEGRO MATE  
(LED)(X5)(3W 5V/1A) USB



WJC292A0088001  
CHROME / CROMO  
(LED)(X5)(3W 5V/1A) USB



WJC292A0088036  
MATTE BLACK / NEGRO MATE  
(LED)(X5)(3W 5V/1A) USB



# Magnifying mirrors

## Espejos de aumento

FREE STANDING MAGNIFY-  
ING MIRROR  
ESPEJO AUMENTO ENCI-  
MERA



WJC277A0084065  
MATTE WHITE / BLANCO MATE  
(x5)



**NEW** WJC277A0084090  
SAND / ARENA  
(x5)



**NEW** WJC277A0084089  
OLIVE / OLIVE  
(x5)



**NEW** WJC277A0084088  
TERRACOTTA / TERRACOTA  
(x5)



WJC277A0084036  
MATTE BLACK / NEGRO MATE  
(x5)



WJC238A0083065  
MATTE WHITE / BLANCO MATE  
(x3)



WJC238A0083036  
MATTE BLACK / NEGRO MATE  
(x3)



WJC292A0086001  
CHROME / CROMO  
(x5)

FREE STANDING MAGNIFY-  
ING MIRROR  
ESPEJO AUMENTO ENCI-  
MERA



WJC292A0086036  
MATTE BLACK / NEGRO MATE  
(x5)



WJC292A0085001  
GLOSSY / BRILLO  
(x5)



WJC292A0085036  
MATTE BLACK / NEGRO MATE  
(x5)



# Toilet brushes

## Escobilleros de baño

**B** CONSULT SPECIAL CONDITIONS\*  
CONSULTAR CONDICIONES ESPECIALES\*

FREE STANDING TOILET  
BRUSH  
ESCOBILLERO SUELO



WJC216A0001081  
WHITE NATUR / BLANCO NATUR



WJC216A0001083  
SAND NATUR / ARENA NATUR



WJC216A0001082  
RUSSET NATUR / TERRACOTA TEXTURIZADO



WJC216A0001080  
BLACK NATUR / NEGRO NATUR



WJC252A0000025  
SOFT WHITE / BLANCO SOFT



WJC252A0000027  
SOFT STONE / PIEDRA SOFT



WJC252A0000028  
SOFT GRAY / GRIS SOFT



WJC252A0000026  
SOFT BLACK / NEGRO SOFT



WJC277A0000065  
MATTE WHITE / BLANCO MATE



**NEW** WJC277A0000090  
SAND / ARENA



**NEW** WJC277A0000089  
OLIVE / OLIVE



**NEW** WJC277A0000088  
TERRACOTA / TERRACOTA



WJC277A0000036  
MATTE BLACK / NEGRO MATE



**NEW** WJC219A0001222 **B**  
SAND / ARENA



**NEW** WJC219A0001403 **B**  
BLOSSOM / BLOSSOM



**NEW** WJC219A0001418 **B**  
OLIVE / OLIVE



WJC215A0001001  
CHROME / CROMO



WJC215A0001036  
MATTE BLACK / NEGRO MATE



WJC226A0001003 **S**  
MATTE STAINLESS STEEL / INOX MATE



WJC226A0001002 **S**  
GLOSSY STAINLESS STEEL / INOX BRILLO



# Toilet brushes

## Escobilleros de baño

FREE STANDING TOILET BRUSH  
 ESCOBILLERO SUELO



WJC226A0001036 **S**  
 MATTE BLACK / NEGRO MATE



WJC235A0001001 **S**  
 CHROME / CROMO



WJC235A0001003 **S**  
 MATTE STAINLESS STEEL / INOX MATE



WJC235A0001040  
 BRUSHED GOLD PVD / ORO CEPILLADO PVD



WJC235A0001054  
 BRUSHED COPPER PVD / COBRE CEPILLADO PVD



WJC235A0001055  
 BRUSHED BLACK PVD / NEGRO CEPILLADO PVD



WJC235A0001036 **S**  
 MATTE BLACK / NEGRO MATE



WJP047A9050001  
 CHROME / CROMO



WJP047A9050036  
 MATTE BLACK / NEGRO MATE



WJP036A9051001  
 CHROME / CROMO



WJP036A9051036  
 MATTE BLACK / NEGRO MATE



WJC235A0001065  
 MATTE WHITE / BLANCO MATE



WJB269A0000001  
 CHROME / CROMO



**NEW NEA** WJB350A0001003  
 MATTE STAINLESS STEEL / INOX MATE



**NEW NEA** WJB350A0001065  
 MATTE WHITE / BLANCO MATE



**NEW NEA** WJB350A0001036  
 MATTE BLACK / NEGRO MATE



WJP038A9050001  
 CHROME / CROMO



WJP038A9050021  
 MATTE STAINLESS STEEL / INOX MATE



WJP038A9050036  
 MATTE BLACK / NEGRO MATE



WJC253A0001001  
 CHROME / CROMO



# Toilet brushes

## Escobilleros de baño

FREE STANDING TOILET BRUSH  
ESCOBILLERO SUELO



WJP056A9050001  
CHROME / CROMO



WJP056A9050036  
MATTE BLACK / NEGRO MATE

WALL TOILET BRUSH HOLDER  
ESCOBILLERO PARED



**NEW** WJC277A0001065  
MATTE WHITE / BLANCO MATE  
DUAL SMARTFIX



**NEW** WJC277A0001090  
SAND / ARENA  
DUAL SMARTFIX



**NEW** WJC277A0001089  
OLIVE / OLIVE  
DUAL SMARTFIX



**NEW** WJC277A0001088  
TERRACOTTA / TERRACOTA  
DUAL SMARTFIX



**NEW** WJC277A0001036  
MATTE BLACK / NEGRO MATE  
DUAL SMARTFIX



WJC215A0000001  
CHROME / CROMO  
DUAL QUICKFIX



WJC215A0000036  
MATTE BLACK / NEGRO MATE  
DUAL QUICKFIX



WJC419A0000001  
CHROME / CROMO



WJC419A0000036  
MATTE BLACK / NEGRO MATE



WJB262A0000001  
CHROME / CROMO  
QUICKFIX



WJB262A0001001  
CHROME / CROMO  
QUICKFIX



WJB264A0000001  
CHROME / CROMO  
QUICKFIX



WJB264A0001001  
CHROME / CROMO  
QUICKFIX



WJB276A0001001  
CHROME / CROMO  
QUICKFIX



WJB276A0001065  
MATTE WHITE / BLANCO MATE  
QUICKFIX



WJB276A0001036  
BLACK-MATTE / NEGRO-MATE  
QUICKFIX



# Toilet brushes

## Escobilleros de baño

WALL TOILET BRUSH  
HOLDER  
ESCOBILLERO PARED



WJC226A0097003 **S**  
MATTE STAINLESS STEEL / INOX MATE



WJC226A0097002 **S**  
GLOSSY STAINLESS STEEL / INOX BRILLO



WJC226A0097036 **S**  
MATTE BLACK / NEGRO MATE



WJC235A0000001 **S**  
CHROME / CROMO



WJC235A0000003 **S**  
MATTE STAINLESS STEEL / INOX MATE



WJC235A0000040  
BRUSHED GOLD PVD / ORO CEPILLADO PVD



WJC235A0000054  
BRUSHED COPPER PVD / COBRE CEPILLADO PVD



WJC235A0000055  
BRUSHED BLACK PVD / NEGRO CEPILLADO PVD



WJC235A0000036 **S**  
MATTE BLACK / NEGRO MATE



WJP047A9001001  
CHROME / CROMO



WJP047A9001036  
MATTE BLACK / NEGRO MATE



**NEW** WJP036A9002001  
CHROME / CROMO  
DUAL SMARTFIX



WJP036A9002036  
MATTE BLACK / NEGRO MATE  
DUAL SMARTFIX



WJC235A0000065  
MATTE WHITE / BLANCO MATE



WJP038A9001001  
CHROME / CROMO



WJP038A9001021  
MATTE STAINLESS STEEL / INOX MATE



WJP038A9001036  
MATTE BLACK / NEGRO MATE



WJC253A0000001  
CHROME / CROMO



WJC268A0001065  
MATTE WHITE / BLANCO MATE



WJC268A0001001  
CHROME-WHITE / CROMO-BLANCO



# Toilet brushes

## Escobilleros de baño

**B** CONSULT SPECIAL CONDITIONS\*  
CONSULTAR CONDICIONES ESPECIALES\*

WALL TOILET BRUSH  
HOLDER  
ESCOBILLERO PARED



WJC268A0001036  
MATTE BLACK / NEGRO MATE

FREE-STANDING OR WALL  
TOILET BRUSH  
ESCOBILLERO SUELO/PARED



**NEW** WJC512A0001001 **B**  
CHROME / CROMO  
DUAL QUICKFIX



**NEW** WJC512A0001090 **B**  
SAND / ARENA  
DUAL QUICKFIX



**NEW** WJC512A0001036 **B**  
MATTE BLACK / NEGRO MATE  
DUAL QUICKFIX



WJC251A0000001  
CHROME / CROMO  
DUAL SMARTFIX



WJC238A0000065  
MATTE WHITE / BLANCO MATE



WJC238A0000036  
MATTE BLACK / NEGRO MATE



WJC268A0000065  
MATTE WHITE / BLANCO MATE



WJC268A0000001  
CHROME-WHITE / CROMO-BLANCO



WJC268A0000036  
MATTE BLACK / NEGRO MATE



**NEW** WJC292A0000001  
CHROME / CROMO



**NEW** WJC292A0000036  
MATTE BLACK / NEGRO MATE

**NEW**



# Hooks & hangers

## Perchas y colgadores

HOOK  
COLGADOR



**NEW** WJC277A0022065  
MATTE WHITE / BLANCO MATE  
DUAL SMARTFIX



**NEW** WJC277A0022090  
SAND / ARENA  
DUAL SMARTFIX



**NEW** WJC277A0022089  
OLIVE / OLIVE  
DUAL SMARTFIX



**NEW** WJC277A0022088  
TERRACOTTA / TERRACOTA  
DUAL SMARTFIX



**NEW** WJC277A0022036  
MATTE BLACK / NEGRO MATE  
DUAL SMARTFIX



WJC215A0021001  
CHROME / CROMO  
DUAL QUICKFIX



WJC215A0021036  
MATTE BLACK / NEGRO MATE  
DUAL QUICKFIX



WJB275A0021001  
CHROME / CROMO  
DUAL QUICKFIX



WJB275A0021065  
MATTE WHITE / BLANCO MATE  
DUAL QUICKFIX



WJB275A0021036  
MATTE BLACK / NEGRO MATE  
DUAL QUICKFIX



WJC419A0021001  
CHROME / CROMO



WJC419A0021036  
MATTE BLACK / NEGRO MATE



WJB262A0021001  
CHROME / CROMO  
QUICKFIX



WJB264A0021001  
CHROME / CROMO  
QUICKFIX



WJB276A0021001  
CHROME / CROMO  
QUICKFIX



WJB276A0021065  
MATTE WHITE / BLANCO MATE  
QUICKFIX



WJB276A0021036  
BLACK-MATTE / NEGRO-MATE  
QUICKFIX



WJC226A0021003 **S**  
MATTE STAINLESS STEEL / INOX MATE



WJC226A0021002 **S**  
GLOSSY STAINLESS STEEL / INOX BRILLO



WJC226A0021036 **S**  
MATTE BLACK / NEGRO MATE



# Hooks & hangers

## Perchas y colgadores

HOOK  
COLGADOR



WJC226A0121003 **S**  
MATTE STAINLESS STEEL / INOX MATE



WJC226A0121002 **S**  
GLOSSY STAINLESS STEEL / INOX BRILLO



WJC226A0121036 **S**  
MATTE BLACK / NEGRO MATE



WJC205A0021001 **S**  
CHROME / CROMO



**NEW** WJC205A1021001  
CHROME / CROMO  
DUAL SMARTFIX



WJC205A0121001  
CHROME / CROMO



WJB005A0102002  
BRIGHT / INOX BRILLO



WJC205A0021003  
BRUSHED STEEL / INOX CEPILLADO



WJC205A0021065  
MATT WHITE / BLANCO MATE



WJC205A0021040  
BRUSHED GOLD PVD / ORO CEPILLADO PVD



WJC205A0021054  
BRUSHED COPPER PVD / COBRE CEPILLADO PVD



WJC205A0021055  
BRUSHED BLACK PVD / NEGRO CEPILLADO PVD



WJC205A0021036  
MATTE BLACK / NEGRO MATE



WJC235A0021001 **S**  
CHROME / CROMO



WJC235A0021003 **S**  
MATTE STAINLESS STEEL / INOX MATE



WJC235A0021065  
MATT WHITE / BLANCO MATE



WJC235A0021040  
BRUSHED GOLD PVD / ORO CEPILLADO PVD



WJC235A0021054  
BRUSHED COPPER PVD / COBRE CEPILLADO PVD



WJC235A0021055  
BRUSHED BLACK PVD / NEGRO CEPILLADO PVD



WJC235A0021036 **S**  
MATTE BLACK / NEGRO MATE



# Hooks & hangers

## Perchas y colgadores

HOOK  
COLGADOR



WJP047A3001001  
CHROME / CROMO



WJP047A3001036  
MATTE BLACK / NEGRO MATE



WJP047A3003001  
CHROME / CROMO



WJP033A3011001  
CHROME / CROMO



WJP036A3011001  
CHROME / CROMO



WJP043A3011001  
CHROME / CROMO



WJP033A3011036  
MATTE BLACK / NEGRO MATE



WJP036A3011036  
MATTE BLACK / NEGRO MATE



WJP043A3011036  
MATTE BLACK / NEGRO MATE



**NEW** WJP033A4011001  
CHROME / CROMO  
DUAL SMARTFIX



**NEW** WJP036A4011001  
CHROME / CROMO  
DUAL SMARTFIX



**NEW** WJP043A4011001  
CHROME / CROMO  
DUAL SMARTFIX



WJP033A3001001  
CHROME / CROMO  
DUAL SMARTFIX



**NEW** WJP033A4011036  
MATTE BLACK / NEGRO MATE  
DUAL SMARTFIX



**NEW** WJP036A4011036  
MATTE BLACK / NEGRO MATE  
DUAL SMARTFIX



**NEW** WJP043A4011036  
MATTE BLACK / NEGRO MATE  
DUAL SMARTFIX



WJP033A3001036  
MATTE BLACK / NEGRO MATE  
DUAL SMARTFIX



WJC238A0021065  
MATTE WHITE / BLANCO MATE



WJC238A0021036  
MATTE BLACK / NEGRO MATE



WJC251A0021001  
CHROME / CROMO



# Hooks & hangers

## Perchas y colgadores

### HOOK COLGADOR



WJB269A0021001  
CHROME / CROMO  
DUAL QUICKFIX



**NEW NEA** WJB350A0021003  
MATTE STAINLESS STEEL / INOX MATE  
DUAL QUICKFIX



**NEW NEA** WJB350A0021065  
MATTE WHITE / BLANCO MATE  
DUAL QUICKFIX



**NEW NEA** WJB350A0021036  
MATTE BLACK / NEGRO MATE  
DUAL QUICKFIX



WJP038A3001001  
CHROME / CROMO



WJP038A3001021  
MATTE STAINLESS STEEL / INOX MATE



WJP038A3001036  
MATTE BLACK / NEGRO MATE



WJC253A0021001  
CHROME / CROMO



WJP049A3001001  
CHROME / CROMO



WJC229A0021001  
CHROME / CROMO



WJC268A0021001  
CHROME / CROMO



WJC268A0021065  
MATTE WHITE / BLANCO MATE



WJC268A0021036  
MATTE BLACK / NEGRO MATE



WJP056A3011001  
CHROME / CROMO



WJP056A3011036  
MATTE BLACK / NEGRO MATE

### DOUBLE HOOK COLGADOR DOBLE



WJC215A0022001  
CHROME / CROMO  
DUAL QUICKFIX



WJC215A0022036  
MATTE BLACK / NEGRO MATE  
DUAL QUICKFIX



WJC419A0022001  
CHROME / CROMO



WJC419A0022036  
MATTE BLACK / NEGRO MATE



# Hooks & hangers

## Perchas y colgadores

DOUBLE HOOK  
COLGADOR DOBLE



WJB276A0022001  
CHROME / CROMO  
QUICKFIX



WJB276A0022065  
MATTE WHITE / BLANCO MATE  
QUICKFIX



WJB276A0022036  
BLACK-MATTE / NEGRO-MATE  
QUICKFIX



WJC205A0022001  
CHROME / CROMO



WJP047A3002001  
CHROME / CROMO



# Toilet roll holders

## Portarrollos

PAPER HOLDER WITH COVER  
PORTARROLLO CON TAPA



WJC215A0059001  
CHROME / CROMO  
DUAL QUICKFIX



WJC215A0059036  
MATTE BLACK / NEGRO MATE  
DUAL QUICKFIX



WJC419A0059001  
CHROME / CROMO



WJC419A0059036  
MATTE BLACK / NEGRO MATE



WJB262A0059001  
CHROME / CROMO  
QUICKFIX



WJB264A0059001  
CHROME / CROMO  
QUICKFIX



WJB276A0059001  
CHROME / CROMO  
QUICKFIX



WJB276A0059065  
MATTE WHITE / BLANCO MATE  
QUICKFIX



WJB276A0059036  
BLACK-MATTE / NEGRO-MATE  
QUICKFIX



WJC226A0059003  
MATTE STAINLESS STEEL / INOX MATE



WJC226A0059002  
GLOSSY STAINLESS STEEL / INOX BRILLO



WJC226A0059036 <sup>5</sup>  
MATTE BLACK / NEGRO MATE



WJC226A0159003  
MATTE STAINLESS STEEL / INOX MATE



WJC226A0159002  
GLOSSY STAINLESS STEEL / INOX BRILLO



WJC226A0159036  
MATTE BLACK / NEGRO MATE



WJC205A0059001  
CHROME / CROMO  
DUAL QUICKFIX



WJC235A0059001 <sup>5</sup>  
CHROME / CROMO

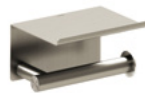

WJC235A0059003 <sup>5</sup>  
MATTE STAINLESS STEEL / INOX MATE



WJC235A0059065  
MATT WHITE / BLANCO MATE



WJC235A0059040  
BRUSHED GOLD PVD / ORO CEPILLA-  
DO PVD



# Toilet roll holders

## Portarrollos

PAPER HOLDER WITH COVER  
PORTARROLLO CON TAPA



WJC235A0059054  
BRUSHED COPPER PVD / COBRE  
CEPILLADO PVD



WJC235A0059055  
BRUSHED BLACK PVD / NEGRO CEPI-  
LLADO PVD



WJC235A0059036   
MATTE BLACK / NEGRO MATE



WJC251A0059001  
CHROME / CROMO



WJC238A0059065  
MATTE WHITE / BLANCO MATE



WJC238A0059036  
MATTE BLACK / NEGRO MATE



WJB269A0059001  
CHROME / CROMO  
DUAL QUICKFIX



WJC229A0056001  
CHROME / CROMO



WJC268A0059001  
CHROME / CROMO



WJC268A0059065  
MATTE WHITE / BLANCO MATE

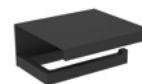

WJC268A0059036  
MATTE BLACK / NEGRO MATE



WJP056A4002001  
CHROME / CROMO



WJP056A4002036  
MATTE BLACK / NEGRO MATE



WJP036A4005001  
CHROME / CROMO  
DUAL QUICKFIX



WJP036A4005036  
MATTE BLACK / NEGRO MATE  
DUAL QUICKFIX



# Toilet roll holders

## Portarrollos

PAPER HOLDER WITHOUT COVER  
PORTARROLLO SIN TAPA



**NEW** WJC277A0062065  
MATTE WHITE / BLANCO MATE  
DUAL SMARTFIX



**NEW** WJC277A0062090  
SAND / ARENA  
DUAL SMARTFIX



**NEW** WJC277A0062089  
OLIVE / OLIVE  
DUAL SMARTFIX



**NEW** WJC277A0062088  
TERRACOTTA / TERRACOTA  
DUAL SMARTFIX



**NEW** WJC277A0062036  
MATTE BLACK / NEGRO MATE  
DUAL SMARTFIX



WJC215A0058001  
CHROME / CROMO  
DUAL QUICKFIX



WJC215A0058036  
MATTE BLACK / NEGRO MATE  
DUAL QUICKFIX



WJB275A1058001  
CHROME-WHITE / CROMO-BLANCO  
DUAL QUICKFIX



WJB275A2058001  
CHROME-RED / CROMO-ROJO  
DUAL QUICKFIX



WJB275A0058001  
CHROME-BLACK / CROMO-NEGRO  
DUAL QUICKFIX



WJB276A0058001  
CHROME / CROMO  
QUICKFIX



WJB276A0096001  
CHROME / CROMO  
QUICKFIX



WJB276A0058065  
MATTE WHITE / BLANCO MATE  
QUICKFIX



WJB276A0096065  
MATTE WHITE / BLANCO MATE  
QUICKFIX



WJB276A0058036  
BLACK-MATTE / NEGRO-MATE  
QUICKFIX



WJB276A0096036  
BLACK-MATTE / NEGRO-MATE  
QUICKFIX



WJC226A0058003 **\$**  
MATTE STAINLESS STEEL / INOX MATE



WJC226A0056003 **\$**  
MATTE STAINLESS STEEL / INOX MATE



WJC226A0058002 **\$**  
GLOSSY STAINLESS STEEL / INOX BRILLO



WJC226A0056002 **\$**  
GLOSSY STAINLESS STEEL / INOX BRILLO



# Toilet roll holders

## Portarrollos

PAPER HOLDER WITHOUT COVER  
PORTARROLLO SIN TAPA



WJC226A0058036   
MATTE BLACK / NEGRO MATE



WJC226A0056036   
MATTE BLACK / NEGRO MATE



WJC226A0158003   
MATTE STAINLESS STEEL / INOX MATE



WJC226A0158002   
GLOSSY STAINLESS STEEL / INOX BRILLO



WJC226A0158036   
MATTE BLACK / NEGRO MATE



WJC205A0058001   
CHROME / CROMO   
DUAL SMARTFIX



WJC235A0058001   
CHROME / CROMO



WJC235A0058003   
MATTE STAINLESS STEEL / INOX MATE



WJC235A0058065   
MATT WHITE / BLANCO MATE



WJC235A0058040   
BRUSHED GOLD PVD / ORO CEPILLADO PVD



WJC235A0058054   
BRUSHED COPPER PVD / COBRE CEPILLADO PVD



WJC235A0058055   
BRUSHED BLACK PVD / NEGRO CEPILLADO PVD



WJC235A0058036   
MATTE BLACK / NEGRO MATE



WJC235A0062001   
CHROME / CROMO



WJC235A0062003   
MATTE STAINLESS STEEL / INOX MATE



WJC235A0062036   
MATTE BLACK / NEGRO MATE



WJP047A4002001   
CHROME / CROMO



WJP047A4002036   
MATTE BLACK / NEGRO MATE



WJP033A1481001   
CHROME / CROMO   
DUAL SMARTFIX



WJP033A1481036   
MATTE BLACK / NEGRO MATE   
DUAL SMARTFIX



# Toilet roll holders

## Portarrollos

PAPER HOLDER WITHOUT COVER  
PORTARROLLO SIN TAPA



WJC251A0058001  
CHROME / CROMO



WJC238A0158036  
MATTE BLACK / NEGRO MATE



WJC238A0158065  
MATTE WHITE / BLANCO MATE



WJC238A0058065  
MATTE WHITE / BLANCO MATE



WJC238A0058036  
MATTE BLACK / NEGRO MATE



WJB269A0058001  
CHROME / CROMO  
DUAL QUICKFIX



**NEW NEA** WJB350A0058003  
MATTE STAINLESS STEEL / INOX MATE  
DUAL QUICKFIX



**NEW NEA** WJB350A0058065  
MATTE WHITE / BLANCO MATE  
DUAL QUICKFIX



**NEW NEA** WJB350A0058036  
MATTE BLACK / NEGRO MATE  
DUAL QUICKFIX



WJP038A4001001  
CHROME / CROMO



WJP038A4001021  
MATTE STAINLESS STEEL / INOX MATE



WJP038A4001036  
MATTE BLACK / NEGRO MATE



WJC253A0058001  
CHROME / CROMO



WJC229A0062001  
CHROME / CROMO



WJC268A0058001  
CHROME / CROMO



WJC268A0058065  
MATTE WHITE / BLANCO MATE



WJC268A0058036  
MATTE BLACK / NEGRO MATE



WJP056A4001001  
CHROME / CROMO



WJP056A4001036  
MATTE BLACK / NEGRO MATE



WJC419A0056001  
CHROME / CROMO



# Toilet roll holders

## Portarrollos

PAPER HOLDER WITHOUT COVER  
PORTARROLLO SIN TAPA



WJC419A0056036  
MATTE BLACK / NEGRO MATE



WJB262A0056001  
CHROME / CROMO  
QUICKFIX



WJB264A0056001  
CHROME / CROMO  
QUICKFIX



WJP047A4001001  
CHROME / CROMO



WJP047A4001036  
MATTE BLACK / NEGRO MATE



WJP038A4002001  
CHROME / CROMO



WJP038A4002021  
MATTE STAINLESS STEEL / INOX MATE



WJP038A4002036  
MATTE BLACK / NEGRO MATE



# Shower baskets

## Jaboneras de ducha

SHOWER SOAP DISH  
JABONERA DE DUCHA



**NEW** WJC277A0033065  
MATTE WHITE / BLANCO MATE  
DUAL SMARTFIX



**NEW** WJC277A0033090  
SAND / ARENA  
DUAL SMARTFIX



**NEW** WJC277A0033089  
OLIVE / OLIVE  
DUAL SMARTFIX



**NEW** WJC277A0033088  
TERRACOTTA / TERRACOTA  
DUAL SMARTFIX



**NEW** WJC277A0033036  
MATTE BLACK / NEGRO MATE  
DUAL SMARTFIX



WJC419A0030001  
CHROME / CROMO



WJC419A0030036  
MATTE BLACK / NEGRO MATE



WJB262A0049001  
CHROME / CROMO  
QUICKFIX



WJB262A0042001  
CHROME / CROMO  
QUICKFIX



WJB264A0049001  
CHROME / CROMO  
QUICKFIX



WJB264A0042001  
CHROME / CROMO  
QUICKFIX



WJB276A0049001  
CHROME / CROMO  
QUICKFIX



WJB276A0049065  
MATTE WHITE / BLANCO MATE  
QUICKFIX



WJB276A0049036  
BLACK-MATTE / NEGRO-MATE  
QUICKFIX



WJC226A0039003  
MATTE STAINLESS STEEL / INOX MATE



WJC226A0039036 **S**  
MATTE BLACK / NEGRO MATE



WJC205A0039002  
GLOSSY / INOX BRILLO



WJC205A0049001  
CHROME / CROMO



WJC205A0048001  
CHROME / CROMO



WJC235A0049001  
CHROME / CROMO



# Shower baskets

## Jaboneras de ducha

SHOWER SOAP DISH  
JABONERA DE DUCHA



WJC235A0049003  
MATTE STAINLESS STEEL / INOX MATE



WJC235A0049065  
MATT WHITE / BLANCO MATE



WJC235A0049040  
BRUSHED GOLD PVD / ORO CEPILLADO PVD



WJC235A0049054  
BRUSHED COPPER PVD / COBRE CEPILLADO PVD



WJC235A0049055  
BRUSHED BLACK PVD / NEGRO CEPILLADO PVD



WJC235A0049036  
MATTE BLACK / NEGRO MATE



WJP047A6020001  
CHROME / CROMO



WJP047A6020036  
MATTE BLACK / NEGRO MATE



WJP033A6020001  
CHROME / CROMO  
DUAL SMARTFIX



WJP033A6020036  
MATTE BLACK / NEGRO MATE  
DUAL SMARTFIX



WJC251A0049051  
CHROME-WHITE / CROMO-BLANCO



WJC238A0049065  
MATTE WHITE / BLANCO MATE



WJC251A0049061  
CHROME-BLACK / CROMO-NEGRO



WJC238A0049036  
MATTE BLACK / NEGRO MATE



WJB269A0049001  
CHROME / CROMO  
DUAL QUICKFIX



WJC419A0049036  
MATTE BLACK / NEGRO MATE  
DUAL QUICKFIX



WJP038A6020001  
CHROME / CROMO



WJP038A6010001  
CHROME / CROMO



WJP038A6020021  
MATTE STAINLESS STEEL / INOX MATE



WJP038A6010036  
MATTE BLACK / NEGRO MATE



# Shower baskets

## Jaboneras de ducha

### SHOWER SOAP DISH JABONERA DE DUCHA



WJP056A6020001  
NATURAL BAMBOO-CHROME / BAMBU  
NATURAL-CROMO



WJP056A6020603  
NATURAL BAMBOO-MATTE BLACK /  
BAMBU NATURAL-NEGRO MATE



WJP014A6123001  
CHROME / CROMO



WJP014A6124001  
CHROME / CROMO



WJP014A6125001  
CHROME / CROMO

### CORNER SHOWER BASKET JABONERA DE DUCHA RINCÓN



WJB262A0041001  
CHROME / CROMO  
QUICKFIX



WJB264A0041001  
CHROME / CROMO  
QUICKFIX



WJC226A0030003 <sup>S</sup>  
MATTE STAINLESS STEEL / INOX MATE



WJC226A0030036  
MATTE BLACK / NEGRO MATE



WJC205A0030002  
GLOSSY / INOX BRILLO



WJC205A0050001  
CHROME / CROMO

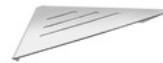

WJP036A6032001  
CHROME / CROMO



WJB269A0050001  
CHROME / CROMO  
DUAL QUICKFIX



WJC419A0050036  
MATTE BLACK / NEGRO MATE  
DUAL QUICKFIX



WJP014A6031001  
CHROME / CROMO



WJP014A6032001  
CHROME / CROMO



WJP014A6033001  
CHROME / CROMO



# Shower baskets

## Jaboneras de ducha

CORNER SHOWER BASKET  
JABONERA DE DUCHA  
RINCÓN



WJP014A6034001  
CHROME / CROMO

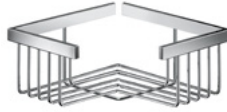

WJP014A6132001  
CHROME / CROMO



WJP014A6133001  
CHROME / CROMO

SHOWER SOAP DISH WITH  
GLASS WIPER  
JABONERA DUCHA CON  
LIMPIACRISTALES



WJC235A0048001 <sup>S</sup>  
CHROME / CROMO



WJC235A0048003 <sup>S</sup>  
MATTE STAINLESS STEEL / INOX MATE



WJC235A0048065  
MATT WHITE / BLANCO MATE



WJC235A0048040  
BRUSHED GOLD PVD / ORO CEPILLADO PVD



WJC235A0048054  
BRUSHED COPPER PVD / COBRE  
CEPILLADO PVD



WJC235A0048055  
BRUSHED BLACK PVD / NEGRO CEPILLADO PVD



WJC235A0048036 <sup>S</sup>  
MATTE BLACK / NEGRO MATE

DOUBLE HANGING SHOWER  
SOAP DISH  
DOBLE JABONERA DE DUCHA  
COLGANTE



WJC235A0047001  
CHROME / CROMO



WJC235A0047036  
MATTE BLACK / NEGRO MATE



# Bins Papeleras

WASTE BIN  
PAPELERA



WJC277A0002036  
MATTE BLACK / NEGRO MATE  
(5L)



WJC235A0002001  
CHROME / CROMO  
(5L)



WJC235A0002003  
MATTE STAINLESS STEEL / INOX MATE  
(5L)



WJC277A0002065  
MATTE WHITE / BLANCO MATE  
(5L)



WJC277A0002087  
STONE / PIEDRA  
(5L)



WJC205A0702002  
GLOSSY STAINLESS STEEL / INOX BRILLO  
(3L)



WJC205A0703002  
GLOSSY STAINLESS STEEL / INOX BRILLO  
(5L)



WJC205A0704002  
GLOSSY STAINLESS STEEL / INOX BRILLO  
(12L)



WJC290A6523000  
MATTE STAINLESS STEEL / INOX MATE  
(20L)



WJC292A0002036  
MATTE BLACK / NEGRO MATE  
(3L)



WJC292A0003036  
MATTE BLACK / NEGRO MATE  
(5L)



WJC292A0004036  
MATTE BLACK / NEGRO MATE  
(5L)



WJP036A9351001  
CHROME / CROMO  
(8L)



WJP056A9350001  
NATURAL BAMBOO-CHROME / BAMBU  
NATURAL-CROMO  
(10L)



WJP056A9350603  
NATURAL BAMBOO-MATTE BLACK /  
BAMBU NATURAL-NEGRO MATE  
(10L)



WJB269A0002001  
CHROME / CROMO  
(5L)



WJB269A0002002  
GLOSSY STAINLESS STEEL / INOX BRILLO  
(5L)

NEW



NEW WJC002A0001065  
MATTE WHITE / BLANCO MATE  
(5L)



NEW WJC002A0001036  
MATTE BLACK / NEGRO MATE  
(5L)



NEW WJC002A0001090  
SAND / ARENA  
(5L)



# Bins Papeleras

WASTE BIN  
PAPELERA



**NEW** WJC002A0002065  
MATTE WHITE / BLANCO MATE

(5L)



**NEW** WJC002A0002036  
MATTE BLACK / NEGRO MATE

(5L)



**NEW** WJC002A0002090  
SAND / ARENA

(5L)



**NEW** WJC002A0003003  
MATTE STAINLESS STEEL / INOX MATE

(6L)

**NEW**



# Furniture accessories

## Accesorios para el mueble

HOOK  
COLGADOR



WJB276A0023001  
CHROME / CROMO



WJB276A0023065  
MATTE WHITE / BLANCO MATE



WJB276A0023036  
BLACK-MATTE / NEGRO-MATE

TOWEL RACK  
TOALLERO COLGAR MUEBLE



WJB276A0066001  
CHROME / CROMO



WJB276A0067001  
CHROME / CROMO



WJB276A0066065  
MATTE WHITE / BLANCO MATE



WJB276A0067065  
MATTE WHITE / BLANCO MATE



WJB276A0066036  
BLACK-MATTE / NEGRO-MATE



WJB276A0067036  
BLACK-MATTE / NEGRO-MATE



# Portables Portátiles

FREE STANDING TOILET  
BRUSH/PAPER HOLDER  
ESCOBILLERO/PORTARROLLO SUELO



WJC235A0097001  
CHROME / CROMO



WJC235A0097065  
MATT WHITE / BLANCO MATE



WJC235A0097040  
BRUSHED GOLD PVD / ORO CEPILLA-  
DO PVD



WJC235A0097036  
MATTE BLACK / NEGRO MATE

NEW



NEW WJC292A0097036  
MATTE BLACK / NEGRO MATE



**Portables**  
**Portátiles**



# Stools Taburetes

STOOL  
TABURETE



WJC277A0006065  
MATTE WHITE / BLANCO MATE



**NEW** WJC277A0006090  
SAND / ARENA



**NEW** WJC277A0006089  
OLIVE / OLIVE



**NEW** WJC277A0006088  
TERRACOTTA / TERRACOTA



WJC277A0006036  
MATTE BLACK / NEGRO MATE



WJC205A0006065  
CHROME-MATTE WHITE / CROMO-BLANCO MATE



WJC205A0006036  
CHROME-MATTE BLACK / CROMO-NEGRO MATE



# Contract

WALL SOAP DISPENSER  
DOSIFICADOR PARED



**WJC290A0025002**  
GLOSSY STAINLESS STEEL / INOX BRILLO

(1500 ML)  
11,9X13,4X24 CM / 4,69X5,28X9,45 IN

TISSUE BOX  
CAJA KLEENEX



**NEW WJC205A1020001**  
CHROME / CROMO

25,8X9X12,7 CM / 10,16X3,54X5 IN

HAIR DRYER  
SECADOR DE PELO



**WJC290A0003000**  
BLACK-CHROME / NEGRO-CROMO

(IP24 100 (IPX0))  
25X11,5X45 CM / 9,84X4,53X17,72 IN

GRAB BAR  
ASA BAÑERA



**WJC251A0024001**  
CHROME / CROMO

40X7X3 CM / 15,75X2,76X1,18 IN



**WJC251A0025001**  
CHROME / CROMO

60X7X3 CM / 23,62X2,76X1,18 IN



**WJC251A0098001**  
CHROME / CROMO

80X7X3 CM / 31,5X2,76X1,18 IN



**WJC251A0099001**  
CHROME / CROMO

100X7X3 CM / 39,37X2,76X1,18 IN

GRAB BAR  
ASA BAÑERA



**WJC205A0010001**  
CHROME / CROMO

(Ø 22MM)  
30X7X6 CM / 11,81X2,76X2,36 IN



**WJC235A0024001**   
CHROME / CROMO

(Ø 22MM)  
30X7X6 CM / 11,81X2,76X2,36 IN



**WJC235A0024003**  
MATTE STAINLESS STEEL / INOX MATE

(Ø 22MM)  
30X7X6 CM / 11,81X2,76X2,36 IN



**WJC235A0024036**   
MATTE BLACK / NEGRO MATE

(Ø 22MM)  
30X7X6 CM / 11,81X2,76X2,36 IN



# Contract

## GRAB BAR ASA BAÑERA



**WJP036A0536001**  
CHROME / CROMO

35X10X6 CM / 13,78X3,94X2,36 IN



**WJP036A0535001**  
CHROME / CROMO

35X9X6 CM / 13,78X3,54X2,36 IN



**WJC205A0011001**  
CHROME / CROMO

45X7X6 CM / 17,72X2,76X2,36 IN



**WJC235A0025001**  
CHROME / CROMO

(Ø 22MM)  
45X7X6 CM / 17,72X2,76X2,36 IN



**WJC235A0025003**  
MATTE STAINLESS STEEL / INOX MATE

(Ø 22MM)  
45X7X6 CM / 17,72X2,76X2,36 IN



**WJC235A0025036**  
MATTE BLACK / NEGRO MATE

(Ø 22MM)  
45X7X6 CM / 17,72X2,76X2,36 IN



**WJC205A0012001**  
CHROME / CROMO

60X7X6 CM / 23,62X2,76X2,36 IN

## RIGHT BATH GRAB BAR ASA BAÑERA DERECHA



**WJC205A0015001**  
CHROME / CROMO

(90°)  
40X7X40 CM / 15,75X2,76X15,75 IN



**WJC205A0013001**  
CHROME / CROMO

(135°)  
49X7X24 CM / 19,29X2,76X9,45 IN

## LEFT BATH GRAB BAR ASA BAÑERA IZQUIERDA



**WJC205A0016001**  
CHROME / CROMO

(90°)  
40X7X40 CM / 15,75X2,76X15,75 IN



**WJC205A0014001**  
CHROME / CROMO

(135°)  
49X7X24 CM / 19,29X2,76X9,45 IN

## GRAB BAR/RIGHT SOAP DISH ASA BAÑERA/REJILLA DERECHA



**WJC205A0026001**  
CHROME / CROMO

50X12,8X24 CM / 19,69X5,04X9,45 IN



# Contract

---

HINGED GRAB BAR  
ASA ABATIBLE



**WJC205A0017001**  
CHROME / CROMO

75X10X30 CM / 29,53X3,94X11,81 IN

---

HINGED GRAB BAR WITH  
PAPER HOLDER  
ASA ABATIBLE CON PORTA-  
RROLLOS



**WJC205A0018001**  
CHROME / CROMO

75X10X30 CM / 29,53X3,94X11,81 IN

---

TOILET PAPER DISPENSER  
DISPENSADOR PAPEL  
HIGIÉNICO



**WJC290A0026002**  
GLOSSY STAINLESS STEEL / INOX BRILLO

25X12,9X25 CM / 9,84X5,08X9,84 IN

---

TOILET TISSUE DISPENSER  
DISPENSADOR PAPEL  
TOALLA



**WJC290A0027002**  
GLOSSY STAINLESS STEEL / INOX BRILLO

27,5X13,2X33 CM / 10,83X5,2X12,99 IN

---

HYGIENIC PLASTIC BAGS  
DISPENSER  
PORTABOLSITAS HIGIÉNICAS



**WJC290A0028001**  
CHROME / CROMO

9,8X2,7X13,7 CM / 3,86X1,06X5,39 IN



**WJC290A0028036**  
MATTE BLACK / NEGRO MATE

9,8X2,7X13,7 CM / 3,86X1,06X5,39 IN



# Contract

SHOWER SEAT  
ASIENTO DE DUCHA



WJC205A0034006  
BLACK / NEGRO

37,2X37,7X6,5 CM / 14,65X14,84X2,56 IN



# Lagoon

Design by **Cosmic Studio**





# Lagoon

Design by Cosmic Studio



**Lagoon is the new collection of furniture, washbasins and mirrors by Cosmic aimed at fans of authenticity. Design originality is as important as the unique nature of Cosmic's values. Lagoon. Eternal and durable.**

**Lagoon es la nueva colección de muebles, lavabos y espejos de Cosmic dirigido a los amantes de lo auténtico. Tan importante es la originalidad del diseño como la singularidad de los valores de Cosmic. Lagoon, eterna y duradera.**

## **HIGH CAPACITY STORAGE**

Under-sink cabinets and the tall cabinet with their distinctive coated handle, allowing for easy opening and closing. The inside of the top drawer has a cut-out for the siphon and an organiser, a solution that allows you to make full use of the space inside bathroom furnishings. There is also personalised detailing on the wood with the Cosmic logo. Interiors in anthracite finish.

## **GRAN CAPACIDAD DE ALMACENAJE**

Los muebles bajo lavabo y el armario alto con su distintivo tirador lacado mate se mimetiza totalmente con el conjunto del mueble y permite una fácil apertura y cierre. El interior del cajón superior dispone de recorte salva sifón y un organizador, una solución para aprovechar el espacio interior de los muebles de baño. Hay que destacar el detalle de madera marcado Cosmic. Interiores en acabado antracita.





#### TALL COLUMN WITH ONE DOOR

Cabinet with extensive storage space and a characteristic front that imitates a delicate thickness of 6 mm.

Door opens to the right or left, non-reversible. It has four thick glass shelves supported by a metal bracket and one fixed wooden shelf that offers the piece stability.

#### COLUMNA ALTA CON UNA PUERTA

Armario con gran espacio de almacenamiento y un frente característico que simula un delicado espesor de 6mm.

La apertura de la puerta puede ser derecha e izquierda, pero no son reversibles. En su interior dispone de 4 estantes de cristal de gran espesor sujetos por una abrazadera metálica y un estante de madera fijo que da estabilidad al conjunto.



#### ROUND-EDGE

The furniture's surface finishes and countertops with built-in washbasins help to increase the perception of comfort, since matte colour coatings and the Solid Surface material of the countertops have a silky texture that is pleasant to the touch.

The exclusive, designer handle blends in perfectly with the piece's organic shapes. Great length and reduced thickness are highlighted by the light when shone on its subtle, frontal groove.

#### CANTOS REDONDEADOS

Los acabados superficiales de los muebles y encimeras con lavabos integrados ayudan a que la percepción de confort sea mayor, ya que los lacados de colores mates y los materiales Solidmat y Gelmat en la encimeras poseen una textura sedosa y agradable al tacto.

El tirador de diseño exclusivo se integra a la perfección con la forma orgánica de la serie. Gran longitud y espesor reducido para una apertura fácil de los cajones y armario.



# Lagoon

Design by Cosmic Studio





**The Lagoon collection wins people over with its harmonious composition that marries traditional stylistic guidelines with modern tendencies. The rounded edges and minimal thicknesses of each feature ensure the set is perceived as a cohesive piece that is accommodating and convenient to use given the scarcity of sharp edges. The effect of the light used highlights all of these properties.**

La colección Lagoon convence con su composición armónica, que une directrices estilísticas tradicionales y modernas. Los cantos redondeados o romos y los espesores mínimos en cada elemento hacen que el conjunto se perciba como una pieza cohesionada, amable y confortable en su uso por la escasez de aristas vivas, y en el que la luz mediante su incidencia se ocupa de destacar todas estas propiedades.



# Lagoon

Design by Cosmic Studio



**This is an extremely versatile collection that offers multiple furnishing combinations with built-in washbasin or countertop basin, and storage options, allowing it to adapt to every requirement.**

**Colección muy versátil que ofrece múltiples combinaciones de muebles con lavabos integrados o lavabos sobre encimera y opciones de almacenaje, para adaptarse a todas las necesidades.**

Construction detail of the fronts, sides, handle and bullnose of the built-in washbasin. Slim fronts, machined with an edge simulating a visible thickness of 6 mm.

Detalle constructivo de los frentes, costados, tirador y canto redondeado o romo del lavabo integrado. Frentes Slim, mecanizados en canto simulando un espesor visto de 6 mm.



## Countertop washbasin | Lavabos de sobre encimera



### WASHBASIN LAGOON SOLIDMAT / LAVABO LAGOON SOLIDMAT



#### SOLIDMAT

The Solid Surface material is a mix formed by the polymerisation of reactive monomers and resins together with a high percentage of natural mineral loads. It features a satin-like, durable finish. This is a fireproof, compact, non-porous, hygienic and strong material. Available in solid matte white.

#### SOLIDMAT

Material Solid Surface, una mezcla formada por la polimerización de resinas y monómeros reactivos junto con un alto porcentaje de cargas minerales naturales. Destaca por su tacto satinado y su durabilidad. Es un material ignífugo, compacto y no poroso, higiénico y resistente. Disponible en blanco mate homogéneo.

### VITREOUS CHINA WASHBASIN LAGOON / LAVABO LAGOON CERÁMICA



#### VITREOUS CHINA

Countertop washbasins made with high-quality glazed ceramics available in three matte colours: white, sand and grey. The mark-free glaze has high chemical resistance and a smooth texture. No overflow.

#### CERÁMICA

Lavabos de sobre encimera fabricados con cerámica esmaltada de alta calidad disponible en 3 colores mate, blanco, arena y gris. Un esmalte de buena resistencia química, libre de manchas y textura lisa. Sin rebosadero.

### VITREOUS CHINA WASHBASIN LAGOON / LAVABO LAGOON CERÁMICA



# Lagoon

Design by Cosmic Studio



**Exclusive built-in washbasin with a large interior basin and round edges made in Solid Surface. Built-in click-clack plug made with the same material. Built-in washbasin with overflow.**

---

**Lavabo integrado exclusivo con un gran seno interior y cantos romos fabricado en Solidmat. Válvula click-clack integrada fabricada con el mismo material. Dispone de rebosadero.**

## Built-in washbain | Lavabos integrados



### GELMAT WASHBAIN / LAVABO GELMAT



#### GEL COAT WITH SUPER-MATTE EFFECT

This is an innovative manufacturing technique that consists of a resin and mineral load compound enriched with an outer gel coat layer. This outer coating grants it a chalk-paint texture and super-matte effect, as well as added durability and resistance. What makes this process innovative is the way the mould is made to obtain a smooth texture free from imperfections. Available in matte sand.

#### GELMAT CON TEXTURA SUPER MATE

Una innovadora técnica de fabricación que consiste en un compuesto de resinas y cargas minerales, enriquecidos con una capa exterior de Gel Coat. Este recubrimiento exterior le confiere textura de pintura a la tiza efecto super mate, aportando un extra de dureza y resistencia. Lo innovador en este proceso consiste en la manera de fabricar el molde para obtener una textura lisa sin imperfecciones. Disponible en color arena mate.

### LAGOON SOLIDMAT WASHBAIN / LAVABO LAGOON SOLIDMAT



#### SOLIDMAT

The Solid Surface material is a mix formed by the polymerisation of reactive monomers and resins together with a high percentage of natural mineral loads. It features a satin-like, durable finish. This is a fireproof, compact, non-porous, hygienic and strong material. Available in solid matte white.

#### SOLIDMAT

Material Solid Surface, una mezcla formada por la polimerización de resinas y monómeros reactivos junto con un alto porcentaje de cargas minerales naturales. Destaca por su tacto satinado y su durabilidad. Es un material ignífugo, compacto y no poroso, higiénico y resistente. Disponible en blanco mate homogéneo.

### SOLIDMAT WASHBAIN / LAVABO SOLIDMAT



# Lagoon

Design by Cosmic Studio





Mirrors with ambient LED lighting encapsulated in a neon tube, with an elastic diffuser and invisible LED points to offer more uniform perimeter lighting. Mirror with polished edge and radius of 10 mm following the same rounded design language as the countertops and furniture to achieve a cohesive set.

Espejos con luz led ambiental encapsulada en tubo de neón, con difusor elástico y puntos de led invisibles, ofrece una iluminación perimetral más uniforme. Espejo con canto pulido de radio 10 mm siguiendo el mismo lenguaje de diseño como de las encimeras y mobiliario para conseguir un conjunto cohesionado.



Polished edge and radius of 10 mm

Canto pulido radio 10 mm



Anti-fog system

Sistema antivaho



Samsung LED 3000 °K

Samsung LED 3000 °K



Switch-on sensor

Sensores de encendido



Switch-off timer

Temporizador de apagado



Anti-condensation system is switched off after 2 hours of operation

El antivaho se apaga a las 2 horas de su funcionamiento

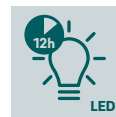

Light is switched off after 12 hours of operation

La luz se apaga a las 12 horas de su funcionamiento

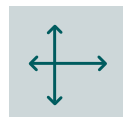

Adjustable wall brackets

Soportes pared regulables



# Lagoon

Design by Cosmic Studio

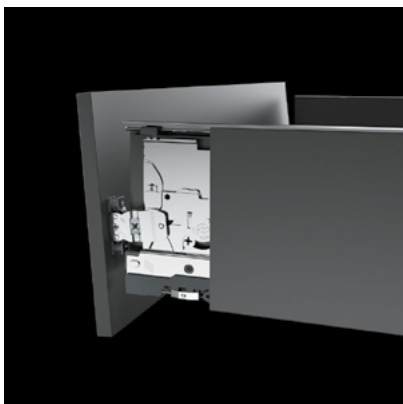

## HETTICH AVANTECH YOU GUIDES

### Exceptional cushioning with gentle closure.

Drawer with Hettich AvanTech YOU metal structure, with depth of 400. It can support up to 40 kg of weight and can be fully removed. Soft Close silent closure, which allows adjustment. The adjustment options (height, side and incline) of the AvanTech YOU drawer system allows you to perfectly align the fronts.

It has no covers or holes that alter the side's clean, straight finish. The framework remains on a second plane, built into the piece as just another component in its slim design. The outer cover slides. The exclusive sliding mechanism allows the front to be released and adjusted vertically and laterally.

## GUÍAS HETTICH AVANTECH YOU

### Amortiguación excepcional, con cierre suave.

Cajón de costilla metálica Hettich Avantech You, con fondo 400 mm. Aguanta hasta 40 Kg de peso y extracción total. Cierre silencioso Soft Close, que permite regulación. Las opciones de ajuste (altura, lateral e inclinación) del sistema de cajones AvanTech YOU permiten crear una alineación de fugas perfecta de los frentes.

Sin tapas, ni agujeros que alteren el acabado limpio y recto del costado. El herraje permanece en segundo plano, integrado en el mueble como un elemento más del delgado diseño. La tapa exterior es deslizante. El exclusivo mecanismo de deslizamiento permite soltar el frente y ajustarlo en altura y lateralmente.

## MDF WOOD

### Round-edge furniture and countertops.

Wooden countertops made in MDF given matte finishes and treated with a high-resistance coating. Of its eight coated finishes, four of them (blue, grey, terracotta and green) are colours developed using waterborne coating processes that are non-toxic and more environmentally friendly. The new Lagoon collection strengthens the company's commitment to sustainability. Under-sink cabinet with two suspended drawers that have edges glued using state-of-the-art thermofusion or PUR (polyurethane reactive) glues, offering improved resistance to humidity given the better seal of the edge.

## MADERA MDF

### Muebles y encimeras de canto romo.

Encimeras de madera fabricadas en MDF lacadas en acabados mate tratadas con un recubrimiento de alta resistencia. De los 8 acabados lacados, 4 de ellos, azul, gris, terracota y verde, son colores desarrollados con procesos de lacado al agua, sin toxicidad y más respetuosos con el medio ambiente. La nueva colección Lagoon refuerza el compromiso de la compañía con la sostenibilidad.

Mueble bajo lavabo de 2 cajones suspendido con cantos encolados con colas de termofusión o PUR (poliuretano reactivo) de última generación que aporta mayor resistencia a la humedad, debido al mejor sellado del canto.

Lagoon has successfully passed the high demanding tests of long last durability to assure long last durability of the product. All products come with 5 years warranty.

Lagoon ha superado con éxito exigentes tests de durabilidad para asegurar una larga vida al producto. Todos los artículos tienen 5 años de garantía.



FSC Certified products.

Productos certificados FSC.



# Furniture | Muebles

## FRONT FRONTAL



SLIM  
SLIM

## STRUCTURE ESTRUCTURA



LAMINATE /  
LACQUERED PANEL  
TABLERO  
LAMINADO / LACADO

## DRAWERS CAJONES



COMPLETE  
EXTENSION  
EXTENSION  
COMPLETA



SOFT-CLOSE  
SYSTEM  
SISTEMA  
SOFT-CLOSE

## WASHBASINS LAVABOS



BUILT IN  
INTEGRADO



COUNTERTOP  
SOBRE-ENCIMERA

## Wooden furniture and countertop | Muebles y encimeras de madera

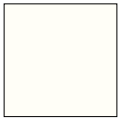

**102**  
MATT WHITE  
BLANCO MATE



**766**  
MATT SAND  
ARENA MATE



**767**  
MATT GREY  
GRIS MATE



**122**  
MATT PINK  
ROSA MATE



**116**  
MATT GREEN  
VERDE MATE



**126**  
MATT BLUE  
AZUL MATE



**768**  
MATT RUSSET  
TERRACOTA MATE



**535**  
MATT ANTHRACITE  
ANTRACITA MATE



## Handles | Tiradores



**102**  
MATT WHITE  
BLANCO MATE



**766**  
MATT SAND  
ARENA MATE



**122**  
MATT PINK  
ROSA MATE



**116**  
MATT GREEN  
VERDE MATE

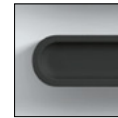

**535**  
MATT ANTHRACITE  
ANTRACITA MATE

## Solidmat: built in washbasins, vanity tops and countertop washbasins Solidmat: lavabos integrados, encimeras y lavabos de sobre encimera

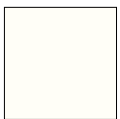

**102**  
MATT WHITE  
BLANCO MATE

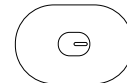
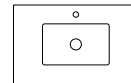
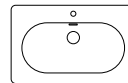

## Gelmat: built in washbasins and countertop Gelmat: lavabos integrados y encimeras



**766**  
MATT SAND  
ARENA MATE

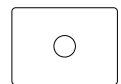
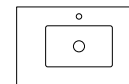

## Vitreous china: over counter top washbasins Cerámica: lavabos de sobre encimera



**102**  
MATT WHITE  
BLANCO MATE



**766**  
MATT SAND  
ARENA MATE



**767**  
MATT GREY  
GRIS MATE

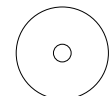
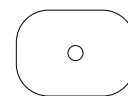

# Lagoon

Design by Cosmic Studio

## 2 DRAWERS CABINET MUEBLE 2 CAJONES

FOR WASHBASIN  
PARA LAVABO



WJC781M0001\_...  
60 CM

WJC781M0002\_...  
80 CM

WJC781M0003\_...  
100 CM

WJC781M0004\_...  
120 CM

FOR RIGHT WASHBASIN  
PARA LAVABO DERECHO

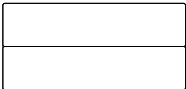

WJC781M0005\_...  
120 CM

FOR LEFT WASHBASIN  
PARA LAVABO IZQUIERDA



WJC781M0006\_...  
120 CM

FOR DOUBLE WASHBASIN  
PARA LAVABO DOBLE



WJC781M0001\_... (x2)  
60 CM

FOR DOUBLE WASHBASIN  
PARA LAVABO DOBLE

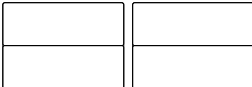

WJC781M0002\_... (x2)  
80 CM

FURNITURE FINISHES  
ACABADOS MUEBLES



## HANDLE TIRADOR

FOR CABINET (X2)  
PARA MUEBLE (X2)



WJC781M0045\_...  
60 CM

WJC781M0046\_...  
80 CM

WJC781M0047\_...  
100 CM

WJC781M0048\_...  
120 CM

FOR CABINET (X2)  
PARA MUEBLE (X2)



WJC781M0048\_...  
120 CM

FOR CABINET (X2)  
PARA MUEBLE (X2)



WJC781M0048\_...  
120 CM

FOR CABINET (X2)  
PARA MUEBLE (X2)



WJC781M0045\_... (x2)  
60 CM

FOR CABINET (X2)  
PARA MUEBLE (X2)



WJC781M0046\_... (x2)  
80 CM

HANDLE FINISHES  
ACABADOS TIRADORES



## BUILT-IN WASHBAIN LAVABO INTEGRADO

WASHBAIN LAGOON (SOLIDMAT)\*  
LAVABO LAGOON (SOLIDMAT)\*

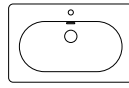

WJC781M0008102  
60 CM

WJC781M0009102  
80 CM

WJC781M0010102  
100 CM

WJC781M0011102  
120 CM

## BUILT-IN WASHBAIN LAVABO INTEGRADO

WASHBAIN (SOLIDMAT)\*  
LAVABO (SOLIDMAT)\*

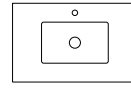

WJC781M0012102  
60 CM

WJC781M0013102  
80 CM

WJC781M0014102  
100 CM

WJC781M0015102  
120 CM

RIGHT WASHBASIN (SOLIDMAT)\*  
LAVABO DERECHA (SOLIDMAT)\*

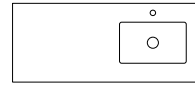

WJC781M0016102  
120 CM

LEFT WASHBASIN (SOLIDMAT)\*  
LAVABO IZQUIERDA (SOLIDMAT)\*

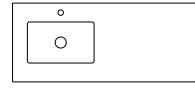

WJC781M0017102  
120 CM

DOUBLE WASHBASIN (SOLIDMAT)\*  
LAVABO DOBLE (SOLIDMAT)\*

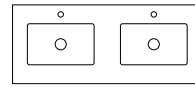

WJC781M0058102  
120 CM

WASHBAIN FINISHES  
ACABADO LAVABO



WASHBAIN FINISHES  
ACABADO LAVABO



INCLUDED



INCLUDED



R10 MM



NOT INCLUDED



NOT INCLUDED



90°



VALVE  
VÁLVULA



OVERFLOW  
ESCOADOURO

# Selection matrix | Matriz de selección

## BUILT-IN WASHBAIN LAVABO INTEGRADO

WASHBAIN (GELMAT)\*  
LAVABO (GELMAT)\*

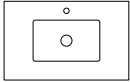

**WJC781M0018766**  
60 CM

**WJC781M0019766**  
80 CM

**WJC781M0020766**  
100 CM

**WJC781M0021766**  
120 CM

## COUNTERTOP ENCIMERA

COUNTERTOP (SOLIDMAT)  
ENCIMERA (SOLIDMAT)

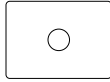

**WJC781M0024102**  
60 CM

**WJC781M0025102**  
80 CM

**WJC781M0026102**  
100 CM

**WJC781M0027102**  
120 CM

## COUNTERTOP ENCIMERA

COUNTERTOP (GELMAT)  
ENCIMERA (GELMAT)

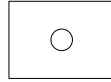

**WJC781M0030766**  
60 CM

**WJC781M0031766**  
80 CM

**WJC781M0032766**  
100 CM

**WJC781M0033766**  
120 CM

## COUNTERTOP ENCIMERA

COUNTERTOP (MDF)  
ENCIMERA (MDF)



**WJC781M0036\_ \_ \_**  
60 CM

**WJC781M0037\_ \_ \_**  
80 CM

**WJC781M0038\_ \_ \_**  
100 CM

**WJC781M0039\_ \_ \_**  
120 CM

RIGHT COUNTERTOP (SOLIDMAT)  
ENCIMERA DERECHA (SOLIDMAT)

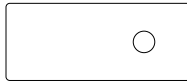

**WJC781M0028102**  
120 CM

RIGHT COUNTERTOP (GELMAT)  
ENCIMERA DERECHA (GELMAT)

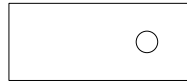

**WJC781M0034766**  
120 CM

LEFT COUNTERTOP (SOLIDMAT)  
ENCIMERA IZQUIERDA (SOLIDMAT)



**WJC781M0029102**  
120 CM

LEFT COUNTERTOP (GELMAT)  
ENCIMERA IZQUIERDA (GELMAT)

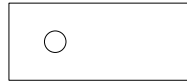

**WJC781M0035766**  
120 CM

DOUBLE COUNTERTOP (SOLIDMAT)  
ENCIMERA DOBLE (SOLIDMAT)

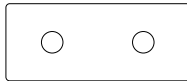

**WJC781M0059102**  
120 CM

DOUBLE COUNTERTOP (SOLIDMAT)  
ENCIMERA DOBLE (SOLIDMAT)



**WJC781M0068102**  
160 CM

WASHBAIN FINISHES  
ACABADO LAVABO



COUNTERTOP FINISHES  
ACABADO ENCIMERA



COUNTERTOP FINISHES  
ACABADO ENCIMERA



COUNTERTOP FINISHES  
ACABADO ENCIMERA



# Lagoon

Design by Cosmic Studio



## 2 DRAWERS CABINET WITH WASHBASIN SOLID-MAT (HANDLE INCLUDED)

MUEBLE 2 CAJONES CON LAVABO SOLIDMAT (INCLUYE TIRADOR)

60X51.8X57.7 CM  
23,62X20,39X22,72 IN

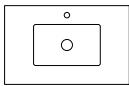
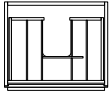
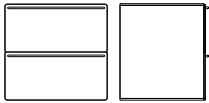

**NEW** WJC781M1101102  
MATT WHITE / BLANCO MATE



**NEW** WJC781M1101766  
MATT SAND / ARENA MATE



**NEW** WJC781M1101122  
MATT PINK / ROSA MATE



**NEW** WJC781M1101116  
MATT GREEN / VERDE MATE



**NEW** WJC781M1101535  
MATT ANTHRACITE / ANTRACITA MATE



## 2 DRAWERS CABINET WITH WASHBASIN SOLID-MAT (HANDLE INCLUDED)

MUEBLE 2 CAJONES CON LAVABO SOLIDMAT (INCLUYE TIRADOR)

80X51.8X57.7 CM  
31,5X20,39X22,72 IN

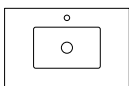
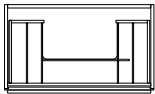

**NEW** WJC781M1102102  
MATT WHITE / BLANCO MATE



**NEW** WJC781M1102766  
MATT SAND / ARENA MATE



**NEW** WJC781M1102122  
MATT PINK / ROSA MATE



**NEW** WJC781M1102116  
MATT GREEN / VERDE MATE



**NEW** WJC781M1102535  
MATT ANTHRACITE / ANTRACITA MATE





**2 DRAWERS CABINET WITH WASHBASIN SOLID-MAT (HANDLE INCLUDED)**

MUEBLE 2 CAJONES CON LAVABO SOLIDMAT (INCLUYE TIRADOR)

100X51,8X57,7 CM  
39,37X20,39X22,72 IN

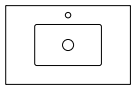
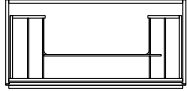

**NEW** WJC781M1103102  
MATT WHITE / BLANCO MATE



**NEW** WJC781M1103766  
MATT SAND / ARENA MATE



**NEW** WJC781M1103122  
MATT PINK / ROSA MATE



**NEW** WJC781M1103116  
MATT GREEN / VERDE MATE



**NEW** WJC781M1103535  
MATT ANTHRACITE / ANTRACITA MATE



**2 DRAWERS CABINET WITH WASHBASIN SOLID-MAT (HANDLE INCLUDED)**

MUEBLE 2 CAJONES CON LAVABO SOLIDMAT (INCLUYE TIRADOR)

120X51,8X57,7 CM  
47,24X20,39X22,72 IN

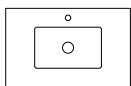
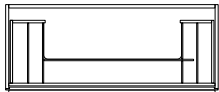
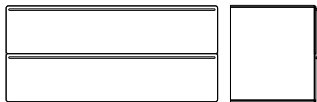

**NEW** WJC781M1104102  
MATT WHITE / BLANCO MATE



**NEW** WJC781M1104766  
MATT SAND / ARENA MATE



**NEW** WJC781M1104122  
MATT PINK / ROSA MATE



**NEW** WJC781M1104116  
MATT GREEN / VERDE MATE



**NEW** WJC781M1104535  
MATT ANTHRACITE / ANTRACITA MATE



# Lagoon

Design by Cosmic Studio



2 DRAWERS CABINET WITH WASHBASIN SOLID-MAT (HANDLE INCLUDED)

MUEBLE 2 CAJONES CON LAVABO SOLIDMAT (INCLUYE TIRADOR)

60X51.8X57.7 CM  
23.62X20.39X22.72 IN

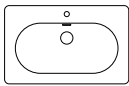
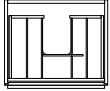
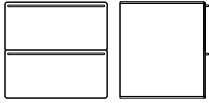

**NEW** WJC781M1001102  
MATT WHITE / BLANCO MATE



**NEW** WJC781M1001766  
MATT SAND / ARENA MATE



**NEW** WJC781M1001122  
MATT PINK / ROSA MATE



**NEW** WJC781M1001116  
MATT GREEN / VERDE MATE



**NEW** WJC781M1001535  
MATT ANTHRACITE / ANTRACITA MATE



2 DRAWERS CABINET WITH WASHBASIN SOLID-MAT (HANDLE INCLUDED)

MUEBLE 2 CAJONES CON LAVABO SOLIDMAT (INCLUYE TIRADOR)

80X51.8X57.7 CM  
31.5X20.39X22.72 IN

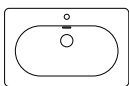
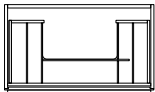

**NEW** WJC781M1002102  
MATT WHITE / BLANCO MATE



**NEW** WJC781M1002766  
MATT SAND / ARENA MATE



**NEW** WJC781M1002122  
MATT PINK / ROSA MATE



**NEW** WJC781M1002116  
MATT GREEN / VERDE MATE



**NEW** WJC781M1002535  
MATT ANTHRACITE / ANTRACITA MATE





**2 DRAWERS CABINET WITH WASHBASIN SOLID-MAT (HANDLE INCLUDED)**

MUEBLE 2 CAJONES CON LAVABO SOLIDMAT (INCLUYE TIRADOR)

100X51,8X57,7 CM  
39,37X20,39X22,72 IN

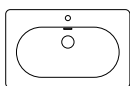
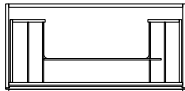

**NEW** WJC781M1003102  
MATT WHITE / BLANCO MATE



**NEW** WJC781M1003766  
MATT SAND / ARENA MATE



**NEW** WJC781M1003122  
MATT PINK / ROSA MATE



**NEW** WJC781M1003116  
MATT GREEN / VERDE MATE



**NEW** WJC781M1003535  
MATT ANTHRACITE / ANTRACITA MATE



**2 DRAWERS CABINET WITH WASHBASIN SOLID-MAT (HANDLE INCLUDED)**

MUEBLE 2 CAJONES CON LAVABO SOLIDMAT (INCLUYE TIRADOR)

120X51,8X57,7 CM  
47,24X20,39X22,72 IN

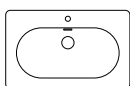
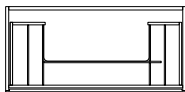
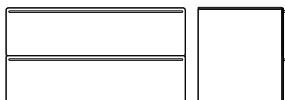

**NEW** WJC781M1004102  
MATT WHITE / BLANCO MATE



**NEW** WJC781M1004766  
MATT SAND / ARENA MATE



**NEW** WJC781M1004122  
MATT PINK / ROSA MATE



**NEW** WJC781M1004116  
MATT GREEN / VERDE MATE



**NEW** WJC781M1004535  
MATT ANTHRACITE / ANTRACITA MATE



# Lagoon

Design by Cosmic Studio



## ■ COLUMN-RIGHT DOOR (HANDLE INCLUDED)

COLUMNA DCHA (INCLUYE TIRADOR)

35X25X162 CM  
13,78X9,84X63,78 IN

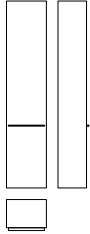

**NEW** WJC781M1007102  
MATT WHITE / BLANCO MATE



**NEW** WJC781M1007766  
MATT SAND / ARENA MATE



**NEW** WJC781M1007122  
MATT PINK / ROSA MATE



**NEW** WJC781M1007116  
MATT GREEN / VERDE MATE



**NEW** WJC781M1007535  
MATT ANTHRACITE / ANTRACITA MATE

## ■ 2 DRAWERS CABINET FOR WASHBASIN

MUEBLE 2 CAJONES PARA LAVABO

60X51,8X56,5 CM  
23,62X20,39X22,24 IN

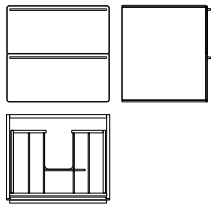

WJC781M0001102  
MATT WHITE / BLANCO MATE



WJC781M0001766  
MATT SAND / ARENA MATE



WJC781M0001767  
MATT GREY / GRIS MATE



WJC781M0001122  
MATT PINK / ROSA MATE



WJC781M0001116  
MATT GREEN / VERDE MATE



WJC781M0001126  
MATT BLUE / AZUL MATE



WJC781M0001768  
MATT RED / TERRACOTA MATE



WJC781M0001535  
MATT ANTHRACITE / ANTRACITA MATE



2 DRAWERS CABINET FOR WASHBASIN  
MUEBLE 2 CAJONES PARA LAVABO

80X51,8X56,5 CM  
31,5X20,39X22,24 IN

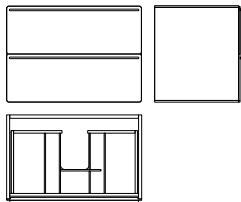

WJC781M0002102  
MATT WHITE / BLANCO MATE



WJC781M0002766  
MATT SAND / ARENA MATE



WJC781M0002767  
MATT GREY / GRIS MATE



WJC781M0002122  
MATT PINK / ROSA MATE



WJC781M0002116  
MATT GREEN / VERDE MATE



WJC781M0002126  
MATT BLUE / AZUL MATE



WJC781M0002768  
MATT RED / TERRACOTA MATE



WJC781M0002535  
MATT ANTHRACITE / ANTRACITA MATE

2 DRAWERS CABINET FOR WASHBASIN  
MUEBLE 2 CAJONES PARA LAVABO

100X51,8X56,5 CM  
39,37X20,39X22,24 IN



WJC781M0003102  
MATT WHITE / BLANCO MATE



WJC781M0003766  
MATT SAND / ARENA MATE



WJC781M0003767  
MATT GREY / GRIS MATE



WJC781M0003122  
MATT PINK / ROSA MATE



WJC781M0003116  
MATT GREEN / VERDE MATE



WJC781M0003126  
MATT BLUE / AZUL MATE



WJC781M0003768  
MATT RED / TERRACOTA MATE



WJC781M0003535  
MATT ANTHRACITE / ANTRACITA MATE

# Lagoon

Design by Cosmic Studio



## 2 DRAWERS CABINET FOR WASHBASIN

MUEBLE 2 CAJONES PARA LAVABO

120X51,8X56,5 CM  
47,24X20,39X22,24 IN

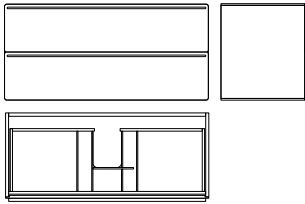

WJC781M0004102  
MATT WHITE / BLANCO MATE



WJC781M0004766  
MATT SAND / ARENA MATE



WJC781M0004767  
MATT GREY / GRIS MATE



WJC781M0004122  
MATT PINK / ROSA MATE



WJC781M0004116  
MATT GREEN / VERDE MATE



WJC781M0004126  
MATT BLUE / AZUL MATE

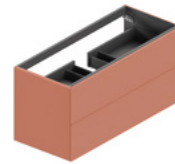

WJC781M0004768  
MATT RED / TERRACOTA MATE



WJC781M0004535  
MATT ANTHRACITE / ANTRACITA MATE

## 2 DRAWERS CABINET FOR WASHBASIN

MUEBLE 2 CAJONES PARA LAVABO

120X51,8X56,5 CM  
47,24X20,39X22,24 IN

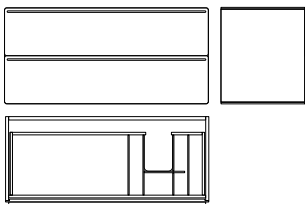

WJC781M0005102  
MATT WHITE / BLANCO MATE



WJC781M0005766  
MATT SAND / ARENA MATE



WJC781M0005767  
MATT GREY / GRIS MATE



WJC781M0005122  
MATT PINK / ROSA MATE



WJC781M0005116  
MATT GREEN / VERDE MATE



WJC781M0005126  
MATT BLUE / AZUL MATE

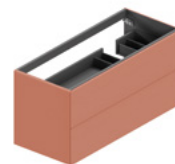

WJC781M0005768  
MATT RED / TERRACOTA MATE



WJC781M0005535  
MATT ANTHRACITE / ANTRACITA MATE



2 DRAWERS CABINET FOR WASHBASIN  
MUEBLE 2 CAJONES PARA LAVABO

120X518X56.5 CM  
47,24X20,39X22,24 IN

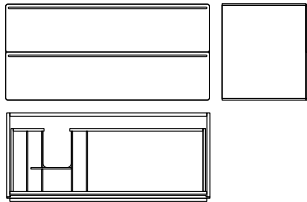

WJC781M0006102  
MATT WHITE / BLANCO MATE



WJC781M0006766  
MATT SAND / ARENA MATE



WJC781M0006767  
MATT GREY / GRIS MATE



WJC781M0006122  
MATT PINK / ROSA MATE



WJC781M0006116  
MATT GREEN / VERDE MATE



WJC781M0006126  
MATT BLUE / AZUL MATE



WJC781M0006768  
MATT RED / TERRACOTA MATE



WJC781M0006535  
MATT ANTHRACITE / ANTRACITA MATE

COLUMN-RIGHT DOOR  
COLUMNA DCHA

35X25X162 CM  
13,78X9,84X63,78 IN

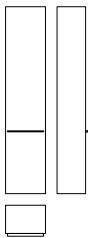

WJC781M0007102  
MATT WHITE / BLANCO MATE



WJC781M0007766  
MATT SAND / ARENA MATE



WJC781M0007767  
MATT GREY / GRIS MATE



WJC781M0007122  
MATT PINK / ROSA MATE



WJC781M0007116  
MATT GREEN / VERDE MATE



WJC781M0007126  
MATT BLUE / AZUL MATE



WJC781M0007768  
MATT RED / TERRACOTA MATE



WJC781M0007535  
MATT ANTHRACITE / ANTRACITA MATE



# Lagoon

Design by **Cosmic Studio**



## ■ COLUMN-LEFT DOOR

COLUMNNA IZDA

35X25X162 CM  
13,78X9,84X63,78 IN

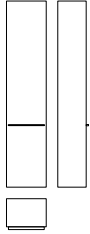

WJC781M0057102  
MATT WHITE / BLANCO MATE



WJC781M0057766  
MATT SAND / ARENA MATE



WJC781M0057767  
MATT GREY / GRIS MATE



WJC781M0057122  
MATT PINK / ROSA MATE

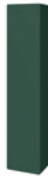

WJC781M0057116  
MATT GREEN / VERDE MATE



WJC781M0057126  
MATT BLUE / AZUL MATE



WJC781M0057768  
MATT RED / TERRACOTA MATE



WJC781M0057535  
MATT ANTHRACITE / ANTRACITA MATE

## ● CABINET HANDLE

TIRADOR COLUMNNA

31,8X1,8X1 CM  
12,52X0,71X0,39 IN

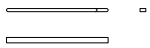

WJC781M0049102  
MATT WHITE / BLANCO MATE



WJC781M0049766  
MATT SAND / ARENA MATE



WJC781M0049122  
MATT PINK / ROSA MATE



WJC781M0049116  
MATT GREEN / VERDE MATE



WJC781M0049535  
MATT ANTHRACITE / ANTRACITA MATE



●  
CABINET HANDLE (X2)  
TIRADOR MUEBLE (X2)

56,3X1,8X1 CM  
22,17X0,71X0,39 IN



WJC781M0045102  
MATT WHITE / BLANCO MATE



WJC781M0045766  
MATT SAND / ARENA MATE



WJC781M0045122  
MATT PINK / ROSA MATE



WJC781M0045116  
MATT GREEN / VERDE MATE



WJC781M0045535  
MATT ANTHRACITE / ANTRACITA  
MATE

●  
CABINET HANDLE (X2)  
TIRADOR MUEBLE (X2)

76,3X1,8X1 CM  
30,04X0,71X0,39 IN

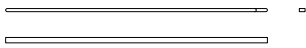

WJC781M0046102  
MATT WHITE / BLANCO MATE



WJC781M0046766  
MATT SAND / ARENA MATE



WJC781M0046122  
MATT PINK / ROSA MATE



WJC781M0046116  
MATT GREEN / VERDE MATE



WJC781M0046535  
MATT ANTHRACITE / ANTRACITA  
MATE



# Lagoon

Design by Cosmic Studio



©  
CABINET HANDLE (X2)  
TIRADOR MUEBLE (X2)  
96,3X1,8X1 CM  
37,91X0,71X0,39 IN



WJC781M0047102  
MATT WHITE / BLANCO MATE



WJC781M0047766  
MATT SAND / ARENA MATE



WJC781M0047122  
MATT PINK / ROSA MATE



WJC781M0047116  
MATT GREEN / VERDE MATE



WJC781M0047535  
MATT ANTHRACITE / ANTRACITA  
MATE

©  
CABINET HANDLE (X2)  
TIRADOR MUEBLE (X2)  
116X1,8X1 CM  
45,67X0,71X0,39 IN

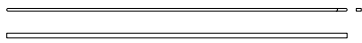

WJC781M0048102  
MATT WHITE / BLANCO MATE



WJC781M0048766  
MATT SAND / ARENA MATE



WJC781M0048122  
MATT PINK / ROSA MATE



WJC781M0048116  
MATT GREEN / VERDE MATE



WJC781M0048535  
MATT ANTHRACITE / ANTRACITA  
MATE





**BUILT-IN WASHBAIN**

LAVABO INTEGRADO LAGOON (SOLIDMAT)

60X50,5X16,9 CM  
23,62X19,88X6,65 IN



INCLUDED



INCLUDED

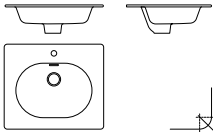

R10 MM



**WJC781M0008102**  
MATT WHITE / BLANCO MATE



**BUILT-IN WASHBAIN**

LAVABO INTEGRADO LAGOON (SOLIDMAT)

80X50,5X16,9 CM  
31,5X19,88X6,65 IN



INCLUDED



INCLUDED

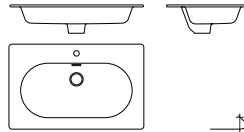

R10 MM



**WJC781M0009102**  
MATT WHITE / BLANCO MATE



**BUILT-IN WASHBAIN**

LAVABO INTEGRADO LAGOON (SOLIDMAT)

100X50,5X16,9 CM  
39,37X19,88X6,65 IN



INCLUDED



INCLUDED

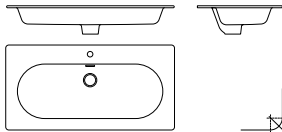

R10 MM



**WJC781M0010102**  
MATT WHITE / BLANCO MATE



**BUILT-IN WASHBAIN**

LAVABO INTEGRADO LAGOON (SOLIDMAT)

120X50,5X16,9 CM  
47,24X19,88X6,65 IN



INCLUDED



INCLUDED

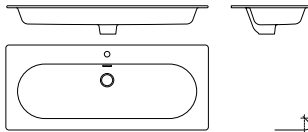

R10 MM



**WJC781M0011102**  
MATT WHITE / BLANCO MATE



**BUILT-IN WASHBAIN WITHOUT HOLE (SOLIDMAT)**

LAVABO INTEGRADO LAGOON SIN AGUJERO (SOLIDMAT)

60X50,5X16,9 CM  
23,62X19,88X6,65 IN



INCLUDED



INCLUDED

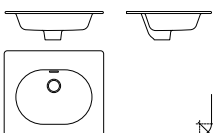

R10 MM



**WJC781M0108102**  
MATT WHITE / BLANCO MATE



**BUILT-IN WASHBAIN WITHOUT HOLE (SOLIDMAT)**

LAVABO INTEGRADO LAGOON SIN AGUJERO (SOLIDMAT)

80X50,5X16,9 CM  
31,5X19,88X6,65 IN



INCLUDED



INCLUDED

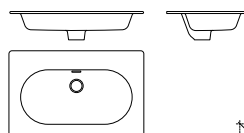

R10 MM



**WJC781M0109102**  
MATT WHITE / BLANCO MATE



**BUILT-IN WASHBAIN WITHOUT HOLE (SOLIDMAT)**

LAVABO INTEGRADO LAGOON SIN AGUJERO (SOLIDMAT)

100X50,5X16,9 CM  
39,37X19,88X6,65 IN



INCLUDED



INCLUDED

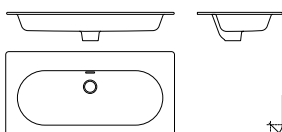

R10 MM



**WJC781M0110102**  
MATT WHITE / BLANCO MATE



**BUILT-IN WASHBAIN WITHOUT HOLE (SOLIDMAT)**

LAVABO INTEGRADO LAGOON SIN AGUJERO (SOLIDMAT)

120X50,5X16,9 CM  
47,24X19,88X6,65 IN



INCLUDED



INCLUDED

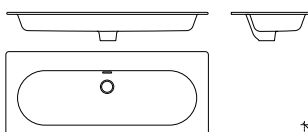

R10 MM



**WJC781M0111102**  
MATT WHITE / BLANCO MATE



**BUILT-IN WASHBAIN**  
LAVABO INTEGRADO (SOLIDMAT)

60X50,5X12,5 CM  
23,62X19,88X4,92 IN

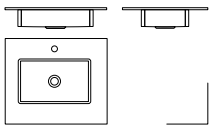

**WJC781M0012102**  
MATT WHITE / BLANCO MATE

**BUILT-IN WASHBAIN**  
LAVABO INTEGRADO (SOLIDMAT)

80X50,5X12,5 CM  
31,5X19,88X4,92 IN

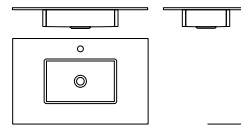

INCH 23.6/31.5/39.4/47.2x19.9x4.9



**WJC781M0013102**  
MATT WHITE / BLANCO MATE

**BUILT-IN WASHBAIN**  
LAVABO INTEGRADO (SOLIDMAT)

100X50,5X12,5 CM  
39,37X19,88X4,92 IN

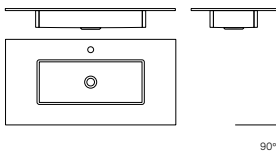

**WJC781M0014102**  
MATT WHITE / BLANCO MATE

**BUILT-IN WASHBAIN**  
LAVABO INTEGRADO (SOLIDMAT)

120X50,5X12,5 CM  
47,24X19,88X4,92 IN

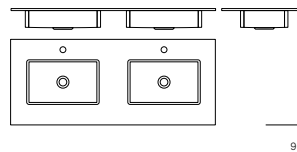

**WJC781M0058102**  
MATT WHITE / BLANCO MATE

**BUILT-IN WASHBAIN**  
LAVABO INTEGRADO (SOLIDMAT)

120X50,5X12,5 CM  
47,24X19,88X4,92 IN

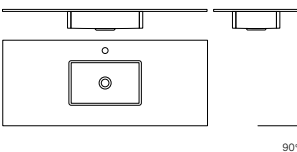

**WJC781M0015102**  
MATT WHITE / BLANCO MATE

**BUILT-IN WASHBAIN**  
LAVABO INTEGRADO (SOLIDMAT)

120X50,5X12,5 CM  
47,24X19,88X4,92 IN

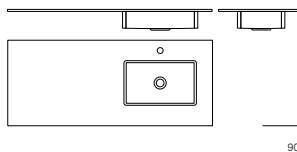

**WJC781M0016102**  
MATT WHITE / BLANCO MATE

**BUILT-IN WASHBAIN**  
LAVABO INTEGRADO (SOLIDMAT)

120X50,5X12,5 CM  
47,24X19,88X4,92 IN

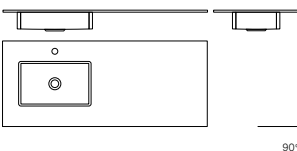

**WJC781M0017102**  
MATT WHITE / BLANCO MATE

**BUILT-IN WASHBAIN WITHOUT HOLE (SOLIDMAT)**  
LAVABO INTEGRADO SIN AGUJERO (SOLIDMAT)

60X50,5X12,5 CM  
23,62X19,88X4,92 IN

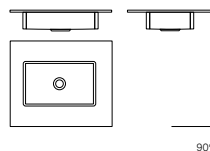

**WJC781M0112102**  
MATT WHITE / BLANCO MATE



**BUILT-IN WASHBAIN WITHOUT HOLE (SOLIDMAT)**  
LAVABO INTEGRADO SIN AGUJERO (SOLIDMAT)

80X50,5X12,5 CM  
31,5X19,88X4,92 IN

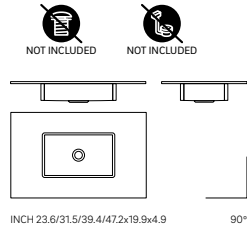

**WJC781M0113102**  
MATT WHITE / BLANCO MATE

**BUILT-IN WASHBAIN WITHOUT HOLE (SOLIDMAT)**  
LAVABO INTEGRADO SIN AGUJERO (SOLIDMAT)

100X50,5X12,5 CM  
39,37X19,88X4,92 IN

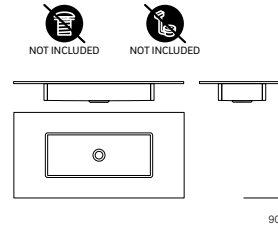

**WJC781M0114102**  
MATT WHITE / BLANCO MATE

**BUILT-IN WASHBAIN WITHOUT HOLE (SOLIDMAT)**  
LAVABO INTEGRADO SIN AGUJERO (SOLIDMAT)

120X50,5X12,5 CM  
47,24X19,88X4,92 IN

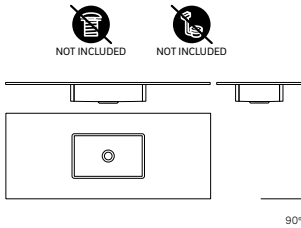

**WJC781M0115102**  
MATT WHITE / BLANCO MATE

**BUILT-IN WASHBAIN WITHOUT HOLE (SOLIDMAT)**  
LAVABO INTEGRADO SIN AGUJERO (SOLIDMAT)

120X50,5X12,5 CM  
47,24X19,88X4,92 IN

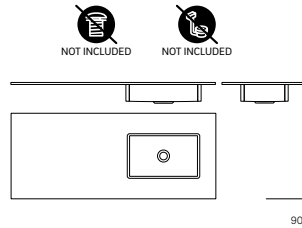

**WJC781M0116102**  
MATT WHITE / BLANCO MATE

**BUILT-IN WASHBAIN WITHOUT HOLE (SOLIDMAT)**  
LAVABO INTEGRADO SIN AGUJERO (SOLIDMAT)

120X50,5X12,5 CM  
47,24X19,88X4,92 IN

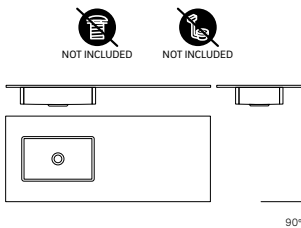

**WJC781M0117102**  
MATT WHITE / BLANCO MATE

**BUILT-IN WASHBAIN WITHOUT HOLE (SOLIDMAT)**  
LAVABO INTEGRADO SIN AGUJERO (SOLIDMAT)

120X50,5X12,5 CM  
47,24X19,88X4,92 IN

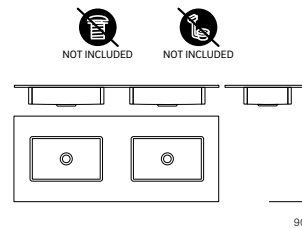

**WJC781M0158102**  
MATT WHITE / BLANCO MATE

**BUILT-IN WASHBAIN**  
LAVABO INTEGRADO (GELMAT)

60X50,5X13,7 CM  
23,62X19,88X5,39 IN

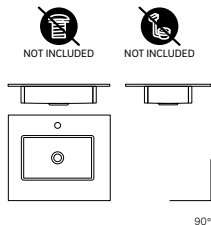

**WJC781M0018766**  
MATT SAND / ARENA MATE

**BUILT-IN WASHBAIN**  
LAVABO INTEGRADO (GELMAT)

80X50,5X13,7 CM  
31,5X19,88X5,39 IN

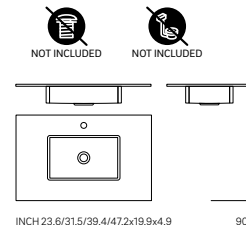

**WJC781M0019766**  
MATT SAND / ARENA MATE

INCH 23,6/31,5/39,4/47,2x19,9x4,9



**BUILT-IN WASHBAIN**  
LAVABO INTEGRADO (GELMAT)

100X50,5X13,7 CM  
39,37X19,88X5,39 IN

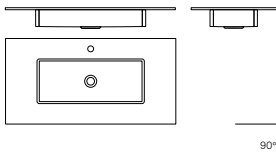

**WJC781M0020766**  
MATT SAND / ARENA MATE

**BUILT-IN WASHBAIN**  
LAVABO INTEGRADO (GELMAT)

120X50,5X13,7 CM  
47,24X19,88X5,39 IN

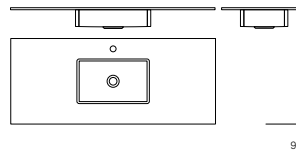

**WJC781M0021766**  
MATT SAND / ARENA MATE

**BUILT-IN WASHBAIN WITHOUT HOLE (GELMAT)**  
LAVABO INTEGRADO SIN AGUJERO (GELMAT)

60X50,5X13,7 CM  
23,62X19,88X5,39 IN

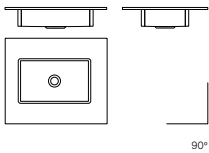

**WJC781M0118766**  
MATT SAND / ARENA MATE

**BUILT-IN WASHBAIN WITHOUT HOLE (GELMAT)**  
LAVABO INTEGRADO SIN AGUJERO (GELMAT)

80X50,5X13,7 CM  
31,5X19,88X5,39 IN

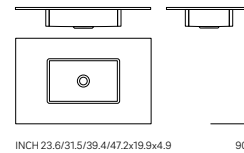

**WJC781M0119766**  
MATT SAND / ARENA MATE

INCH 23.6/31.5/39.4/47.2x19.9x4.9

**BUILT-IN WASHBAIN WITHOUT HOLE (GELMAT)**  
LAVABO INTEGRADO SIN AGUJERO (GELMAT)

100X50,5X13,7 CM  
39,37X19,88X5,39 IN

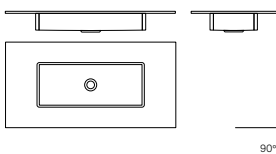

**WJC781M0120766**  
MATT SAND / ARENA MATE

**BUILT-IN WASHBAIN WITHOUT HOLE (GELMAT)**  
LAVABO INTEGRADO SIN AGUJERO (GELMAT)

120X50,5X13,7 CM  
47,24X19,88X5,39 IN

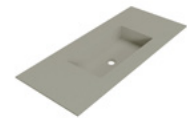
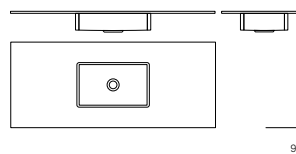

**WJC781M0121766**  
MATT SAND / ARENA MATE

**COUNTERTOP WASHBASIN**  
LAVABO SOBRE ENCIMERA LAGOON

45X30X11 CM  
17,72X11,81X4,33 IN

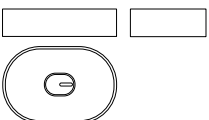

**WJC781M0042102**  
MATT WHITE / BLANCO MATE



⚙️  
**COUNTERTOP WASHBASIN**  
 LAVABO SOBRE ENCIMERA

45,5X33X13,5 CM  
 17,91X12,99X5,31 IN

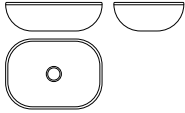

**WJC781M0043102**  
 MATT WHITE / BLANCO MATE



**WJC781M0043766**  
 MATT SAND / ARENA MATE



**WJC781M0043767**  
 MATT GREY / GRIS MATE

⚙️  
**COUNTERTOP WASHBASIN**  
 LAVABO SOBRE ENCIMERA

35X35X11,5 CM  
 13,78X13,78X4,53 IN

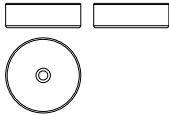

**WJC781M0044102**  
 MATT WHITE / BLANCO MATE



**WJC781M0044766**  
 MATT SAND / ARENA MATE

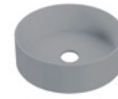

**WJC781M0044767**  
 MATT GREY / GRIS MATE

Ⓐ  
**COUNTERTOP**  
 ENCIMERA (SOLIDMAT)

60X50,5X12 CM  
 23,62X19,88X0,47 IN

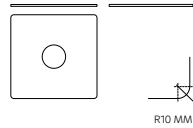

**WJC781M0024102**  
 MATT WHITE / BLANCO MATE

Ⓐ  
**COUNTERTOP**  
 ENCIMERA (SOLIDMAT)

80X50,5X12 CM  
 31,5X19,88X0,47 IN

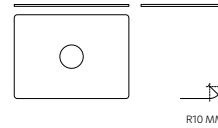

**WJC781M0025102**  
 MATT WHITE / BLANCO MATE

Ⓐ  
**COUNTERTOP**  
 ENCIMERA (SOLIDMAT)

100X50,5X12 CM  
 39,37X19,88X0,47 IN

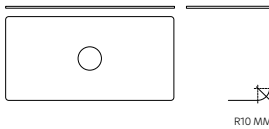

**WJC781M0026102**  
 MATT WHITE / BLANCO MATE

Ⓐ  
**COUNTERTOP**  
 ENCIMERA (SOLIDMAT)

120X50,5X12 CM  
 47,24X19,88X0,47 IN

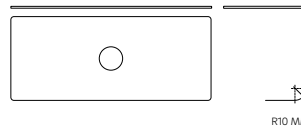

**WJC781M0027102**  
 MATT WHITE / BLANCO MATE



④  
**COUNTERTOP**  
ENCIMERA (SOLIDMAT)  
120X50,5X12 CM  
47,24X19,88X0,47 IN

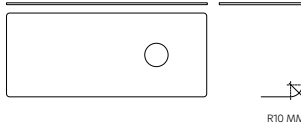

**WJC781M0028102**  
MATT WHITE / BLANCO MATE

④  
**COUNTERTOP**  
ENCIMERA (SOLIDMAT)  
120X50,5X12 CM  
47,24X19,88X0,47 IN

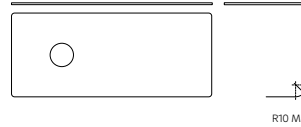

**WJC781M0029102**  
MATT WHITE / BLANCO MATE

④  
**COUNTERTOP**  
ENCIMERA (SOLIDMAT)  
120X50,5X12 CM  
47,24X19,88X0,47 IN

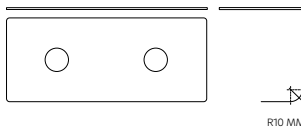

**WJC781M0059102**  
MATT WHITE / BLANCO MATE

④  
**COUNTERTOP**  
ENCIMERA (SOLIDMAT)  
160X50,5X12 CM  
62,99X19,88X0,47 IN

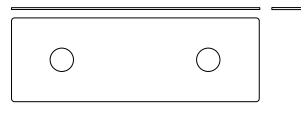

**WJC781M0068102**  
MATT WHITE / BLANCO MATE

④  
**COUNTERTOP**  
ENCIMERA (GELMAT)  
60X50,5X12 CM  
23,62X19,88X0,47 IN

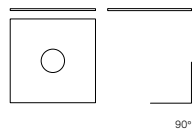

**WJC781M0030766**  
MATT SAND / ARENA MATE

④  
**COUNTERTOP**  
ENCIMERA (GELMAT)  
80X50,5X12 CM  
31,5X19,88X0,47 IN

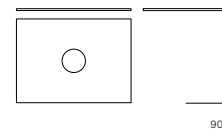
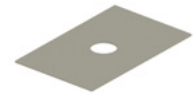

**WJC781M0031766**  
MATT SAND / ARENA MATE

④  
**COUNTERTOP**  
ENCIMERA (GELMAT)  
100X50,5X12 CM  
39,37X19,88X0,47 IN

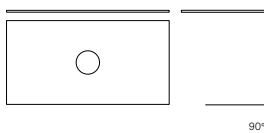

**WJC781M0032766**  
MATT SAND / ARENA MATE

④  
**COUNTERTOP**  
ENCIMERA (GELMAT)  
120X50,5X12 CM  
47,24X19,88X0,47 IN

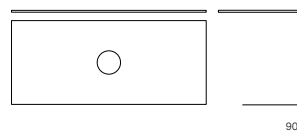

**WJC781M0033766**  
MATT SAND / ARENA MATE



④  
**COUNTERTOP**  
ENCIMERA (GELMAT)  
120X50,5X12 CM  
47,24X19,88X0,47 IN

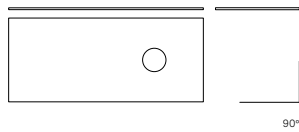

**WJC781M0034766**  
MATT SAND / ARENA.MATE

④  
**COUNTERTOP**  
ENCIMERA (GELMAT)  
120X50,5X12 CM  
47,24X19,88X0,47 IN

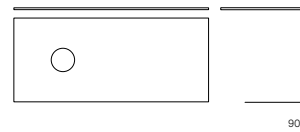

**WJC781M0035766**  
MATT SAND / ARENA.MATE



# Lagoon

Design by Cosmic Studio

■  
COUNTERTOP  
ENCIMERA (MDF)  
60X50,5X19 CM  
23,62X19,88X0,75 IN

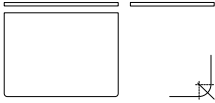

WJC781M0036102  
MATT WHITE / BLANCO MATE



WJC781M0036766  
MATT SAND / ARENA MATE



WJC781M0036767  
MATT GREY / GRIS MATE



WJC781M0036122  
MATT PINK / ROSA MATE



WJC781M0036116  
MATT GREEN / VERDE MATE



WJC781M0036126  
MATT BLUE / AZUL MATE



WJC781M0036768  
MATT RED / TERRACOTA MATE



WJC781M0036535  
MATT ANTHRACITE / ANTRACITA  
MATE

■  
COUNTERTOP  
ENCIMERA (MDF)  
80X50,5X19 CM  
31,5X19,88X0,75 IN

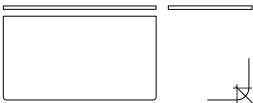

WJC781M0037102  
MATT WHITE / BLANCO MATE

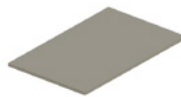

WJC781M0037766  
MATT SAND / ARENA MATE



WJC781M0037767  
MATT GREY / GRIS MATE



WJC781M0037122  
MATT PINK / ROSA MATE



WJC781M0037116  
MATT GREEN / VERDE MATE



WJC781M0037126  
MATT BLUE / AZUL MATE



WJC781M0037768  
MATT RED / TERRACOTA MATE



WJC781M0037535  
MATT ANTHRACITE / ANTRACITA  
MATE



■  
COUNTERTOP  
ENCIMERA (MDF)

100X50,5X1,9 CM  
39,37X19,88X0,75 IN

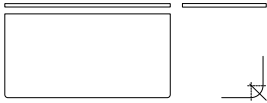

WJC781M0038102  
MATT WHITE / BLANCO MATE

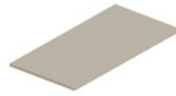

WJC781M0038766  
MATT SAND / ARENA MATE



WJC781M0038767  
MATT GREY / GRIS MATE



WJC781M0038122  
MATT PINK / ROSA MATE



WJC781M0038116  
MATT GREEN / VERDE MATE



WJC781M0038126  
MATT BLUE / AZUL MATE

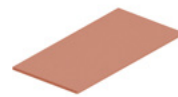

WJC781M0038768  
MATT RED / TERRACOTA MATE



WJC781M0038535  
MATT ANTHRACITE / ANTRACITA  
MATE

■  
COUNTERTOP  
ENCIMERA (MDF)

120X50,5X1,9 CM  
47,24X19,88X0,75 IN



WJC781M0039102  
MATT WHITE / BLANCO MATE



WJC781M0039766  
MATT SAND / ARENA MATE



WJC781M0039767  
MATT GREY / GRIS MATE



WJC781M0039122  
MATT PINK / ROSA MATE



WJC781M0039116  
MATT GREEN / VERDE MATE



WJC781M0039126  
MATT BLUE / AZUL MATE



WJC781M0039768  
MATT RED / TERRACOTA MATE



WJC781M0039535  
MATT ANTHRACITE / ANTRACITA  
MATE



# Lagoon

Design by **Cosmic Studio**

◆  
AMBIENT LED LIGHTING MIRROR  
ESPEJO LED AMBIENTAL REDONDO

60X2,9X60 CM  
23,62X1,14X23,62 IN



WJC781M0064000

◆  
AMBIENT LED LIGHTING MIRROR  
ESPEJO LED AMBIENTAL REDONDO

80X2,9X80 CM  
31,5X1,14X31,5 IN



WJC781M0065000

◆  
AMBIENT LED LIGHTING MIRROR  
ESPEJO LED AMBIENTAL REDONDO

100X2,9X100 CM  
39,37X1,14X39,37 IN



WJC781M0066000

◆  
AMBIENT LED LIGHTING MIRROR  
ESPEJO LED AMBIENTAL  
CUADRADO

60X2,9X80 CM  
23,62X1,14X31,5 IN



WJC781M0060000

◆  
AMBIENT LED LIGHTING MIRROR  
ESPEJO LED AMBIENTAL  
CUADRADO

80X2,9X80 CM  
31,5X1,14X31,5 IN



WJC781M0061000

◆  
AMBIENT LED LIGHTING MIRROR  
ESPEJO LED AMBIENTAL  
CUADRADO

100X2,9X80 CM  
39,37X1,14X31,5 IN



WJC781M0062000

◆  
AMBIENT LED LIGHTING MIRROR  
ESPEJO LED AMBIENTAL  
CUADRADO

120X2,9X80 CM  
47,24X1,14X31,5 IN



WJC781M0063000

◆  
AMBIENT LED LIGHTING MIRROR  
ESPEJO LED AMBIENTAL  
OVALADO

50X2,9X100 CM  
19,69X1,14X39,37 IN



WJC781M0067000





**FREE DRAIN VALVE**

VÁLVULA DESCARGA LIBRE

7,5X7,5X9,1 CM  
2,95X2,95X3,58 IN



**WJC341R0786000**  
MATTE WHITE / BLANCO MATE



**WJC341R0787000**  
MATTE BLACK / NEGRO MATE



**WJC341R7600000**  
CHROME / CROMO



**POP-UP VALVE**

VÁLVULA CLICK CLACK

6,2X6,2X8,4 CM  
2,44X2,44X3,31 IN



**WJC341R0789000**  
MATTE WHITE / BLANCO MATE



**WJC341R0790000**  
MATTE BLACK / NEGRO MATE



**WJC341R0387000**  
CHROME / CROMO



**POP-UP VALVE**

VÁLVULA CLICK-CLACK  
LAGOON

7X7X10 CM  
2,76X2,76X3,94 IN



**WJC781M0055102**  
MATT WHITE / BLANCO MATE



**POP-UP VALVE**

VALVULA CLICK-CLACK

7X7X10 CM  
2,76X2,76X3,94 IN



**WJC781M0056766**  
MATT SAND / ARENA MATE



# Wish

Design by **Cosmic Studio**







Wish is a modern piece of furniture made of high quality materials.

Wish, colección de mobiliario con un diseño actual y fabricada con materiales de alta calidad.



Eye-catching  
ornamental glass.

Vidrio ornamental acanalado con rayas verticales que aportan un juego de sombras y brillos que dan elegancia y modernidad al baño.





ORNAMENTAL  
GLASS FRONT  
FRONTAL VIDRIO  
LACADO ACANALADO



Furniture from the Wish series was created for the most demanding users. The ornamental elements present in the collection have unique decorative qualities.

The symmetrical design of the cabinets from the Wish collection has been refined with vertical stripes of ornamental glass.

Los muebles de la serie Wish fueron creados para los usuarios más exigentes. Los elementos ornamentales presentes en la colección tienen cualidades decorativas únicas.

El mueble de 2 cajones de la colección Wish se ha decorado con cristal ornamental texturado con rayas verticales.





Metal sides of the drawers with full extension and the Soft Close system ensure easy access to the contents as well as quiet and gentle closing.

Los laterales metálicos de los cajones con extracción total y el sistema Soft Close garantizan un fácil acceso al contenido, así como un cierre suave y silencioso.



**Wish** Design by **Cosmic Studio**





A flexible range of two drawers cabinet of three sizes 60,80 and 100 CM, that combines with two types of basins: built-in basin and counter-top basin.

Gama flexible de muebles de dos cajones en 3 medidas, 60, 80, y 100 cm, que pueden combinar con un lavabo integrado o de sobre encimera.



**Wish** Design by **Cosmic Studio**







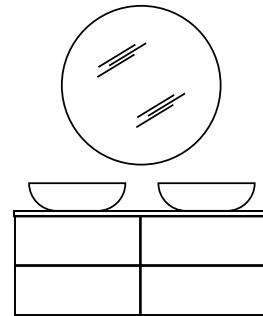
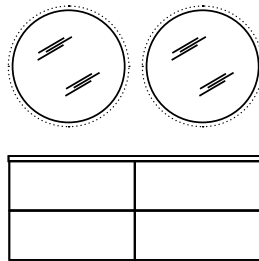
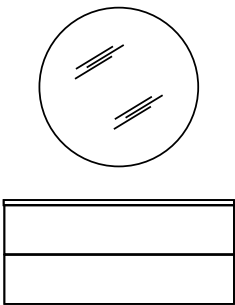
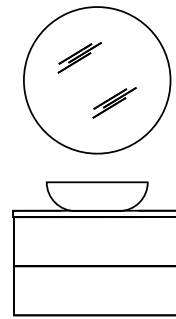
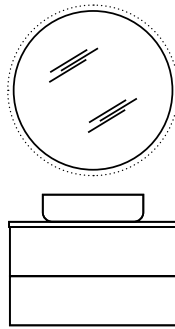
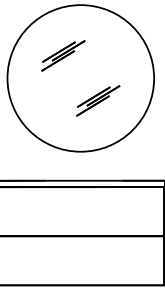
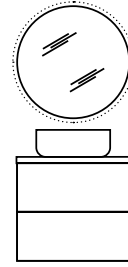
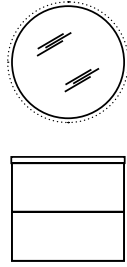
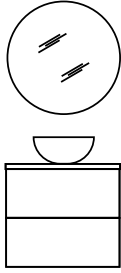



#### ORNAMENTAL GLASS

Unlike the clear (float) glass, during the manufacturing process, the ornamental glass passes through two laminating rolls out of which one is etched with a motif.

#### VIDRIO ORNAMENTAL

A diferencia del vidrio transparente (flotado), durante el proceso de fabricación, el vidrio ornamental pasa a través de dos rollos de laminación, de los cuales uno está grabado con un motivo.

#### VITREOUS CHINA COUNTERTOP WASHBASIN

The washbasin is made in a traditional way, it is characterized by high durability, resistance to abrasion and chemical agents. They are available in 5 colours: glossy white, matt smoked, matt black, matt green and matt blue.

#### LAVABO DE CERÁMICA

El lavabo está hecho de forma tradicional, se caracteriza por una alta durabilidad, resistencia a la abrasión y agentes químicos. Disponibles en 5 colores: blanco brillo, fumé mate, negro mate, verde mate y azul mate.

#### MÁRMOL CALACATTA Y MARQUINA

Encimeras de piedra natural compacta de 2 cm en acabado mate con acabado de impresión digital. La encimeras se fabrican procesando materias primas naturales compuesta por 95 % marmol natural molido, 4,8% resina ortoftálica de poliéster insaturada, 0,2% colorantes. La piedra compacta, como material natural, puede presentar marcas leves y variaciones de color, tonalidad y en su textura.

Los artículos fabricados con estos materiales son resistentes a los Cambios de temperatura, agentes químicos y resistentes a productos de limpieza según lo que establecen las normas UNE - EN 14527 y UNE-EN 14688.

#### CALACATTA AND MARQUINA MARBLE

2 cm compact natural stone countertops in matt finish with digital printing finish. The countertops are manufactured by processing natural raw materials composed of 95% ground natural marble, 4.8% unsaturated polyester orthophthalic resin, 0.2% dyes. Compact stone, as a natural material, may present slight marks and variations in colour, tone and texture.

The articles manufactured with these materials are resistant to changes in temperature, chemical agents and

resistant to cleaning products according to the provisions of UNE - EN 14527 and UNE-EN 14688.

#### HIGH PRESSURE COMPACT MARBLE

It is an innovative 1.5 cm technological polymer material, made up of a mixture of high-quality mineral fillers and manufactured under high pressure, combined with a high-performance color synthetic coating based on state-of-the-art nanoparticles, which gives it high antibacterial properties, impermeability with great resistance to scratches, stains and chemical agents, as well as a matte finish with a soft and silky texture that is very easy to clean.

#### MÁRMOL COMPACTO DE ALTA PRESIÓN

Es un novedoso material polímero tecnológico de 1,5 cm, compuesto por una mezcla de cargas minerales de alta calidad y fabricado a alta presión, combinado con un recubrimiento sintético color de alto rendimiento a base de nano partículas de última generación, lo que le confiere altas propiedades antibacterianas, impermeabilidad con gran resistencia a los rayados, manchas y agentes químicos, además de un acabado mate con textura suave y sedosa de muy fácil limpieza.



FSC Certified products

Productos certificados FSC.



FRONT  
FRONTAL



LAMINATE BOARD  
+ GLASS  
TABLERO LAMINADO  
+ CRISTAL

STRUCTURE  
ESTRUCTURA



LAMINATE /  
LACQUERED BOARD  
TABLERO  
LAMINADO / LACADO

DRAWERS  
CAJONES



EXTENSIÓN  
COMPLETA  
EXTENSIÓN  
COMPLETA



SISTEMA  
SOFT-CLOSE  
SISTEMA  
SOFT-CLOSE

WASHBASINS  
LAVABOS



BUILT IN  
INTEGRADO



COUNTERTOP  
SOBRE-ENCIMERA

Furniture | Muebles



**110**  
CREAM LIGHT  
FUME MATT  
CREMA LIGHT  
FUME MATE



**116**  
GREEN MATT  
VERDE MATE

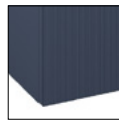

**126**  
NAVY BLUE  
MATT  
AZUL MARINO  
MATE

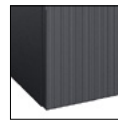

**108**  
BLACK MATT  
NEGRO MATE

Handles | Tiradores



**001**  
CHROM  
CROMO BRILLO

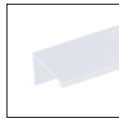

**065**  
WHITE MATT  
BLANCO MATE

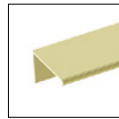

**744**  
GLOSSY GOLD  
ORO BRILLO

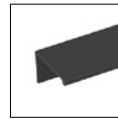

**036**  
BLACK MATT  
NEGRO MATE



Mirrors | Espejos



**740**  
GOLD MATT  
ORO MATE



**108**  
BLACK MATT  
NEGRO MATE

Vitreous china countertop washbasin | Lavabos de cerámica



**530**  
GLOSSY WHITE  
BLANCO BRILLO



**110**  
CREAM LIGHT  
FUME MATT  
CREMA LIGHT  
FUME MATE



**116**  
GREEN MATT  
VERDE MATE



**126**  
NAVY BLUE  
MATT  
AZUL MARINO  
MATE



**108**  
BLACK MATT  
NEGRO MATE

Countertops | Encimeras



**102**  
WHITE MATT  
BLANCO MATE

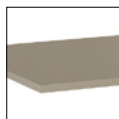

**110**  
CREAM LIGHT  
FUME MATT  
CREMA LIGHT  
FUME MATE



**116**  
GREEN MATT  
VERDE MATE



**126**  
NAVY BLUE  
MATT  
AZUL MARINO  
MATE



**108**  
BLACK MATT  
NEGRO MATE

MARBLE / MÁRMOL



**205**  
WHITE MATT  
MARBLE CALACATTA  
MÁRMOL  
CALACATTA MATE



**241**  
BLACK MATT  
MARBLE MARGUINA  
MÁRMOL  
MARGUINA MATE



■ ❄️  
2 DRAWERS CABINET WITH WASHBASIN  
(CHROME HANDLE INCLUDED)  
MUEBLE 2 CAJONES CON LAVABO  
(INCLUYE TIRADOR CROMO)

60X45,3X65 CM  
23,62X17,83X25,59 IN

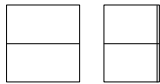

**NEW** WJC780M3060110  
CREAM LIGHT MATT / CREMA LIGHT MATE



**NEW** WJC780M3060116  
GREEN MATT / VERDE MATE



**NEW** WJC780M3060126  
NAVY BLUE MATT / AZUL MARINO MATE



**NEW** WJC780M3060108  
MATTE BLACK / NEGRO MATE

■ ❄️  
2 DRAWERS CABINET WITH WASHBASIN  
(CHROME HANDLE INCLUDED)  
MUEBLE 2 CAJONES CON LAVABO  
(INCLUYE TIRADOR CROMO)

80X45,3X65 CM  
31,5X17,83X25,59 IN

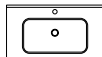

**NEW** WJC780M3080110  
CREAM LIGHT MATT / CREMA LIGHT MATE



**NEW** WJC780M3080116  
GREEN MATT / VERDE MATE



**NEW** WJC780M3080126  
NAVY BLUE MATT / AZUL MARINO MATE



**NEW** WJC780M3080108  
MATTE BLACK / NEGRO MATE

■ ❄️  
2 DRAWERS CABINET WITH WASHBASIN  
(CHROME HANDLE INCLUDED)  
MUEBLE 2 CAJONES CON LAVABO  
(INCLUYE TIRADOR CROMO)

100X45,3X65 CM  
39,37X17,83X25,59 IN

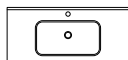

**NEW** WJC780M4100110  
CREAM LIGHT MATT / CREMA LIGHT MATE



**NEW** WJC780M4100116  
GREEN MATT / VERDE MATE



**NEW** WJC780M4100126  
NAVY BLUE MATT / AZUL MARINO MATE



**NEW** WJC780M4100108  
MATTE BLACK / NEGRO MATE

■  
2 DRAWERS CABINET FOR WASHBASIN  
MUEBLE 2 CAJONES PARA LAVABO

60X45,3X63,5 CM  
23,62X17,83X25 IN

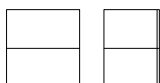

WJC780M0060110  
CREAM LIGHT MATT / CREMA LIGHT MATE



WJC780M0060116  
GREEN MATT / VERDE MATE



WJC780M0060126  
NAVY BLUE MATT / AZUL MARINO MATE



WJC780M0060108  
MATTE BLACK / NEGRO MATE



2 DRAWERS CABINET FOR WASHBASIN  
MUEBLE 2 CAJONES PARA LAVABO

80X45,3X63,5 CM  
31,5X17,83X25 IN

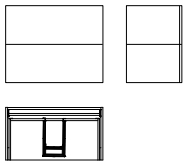

WJC780M0080110  
CREAM LIGHT MATT / CREMA LIGHT MATE



WJC780M0080116  
GREEN MATT / VERDE MATE



WJC780M0080126  
NAVY BLUE MATT / AZUL MARINO MATE



WJC780M0080108  
MATTE BLACK / NEGRO MATE

2 DRAWERS CABINET FOR WASHBASIN  
MUEBLE 2 CAJONES PARA LAVABO

100X45,3X63,5 CM  
39,37X17,83X25 IN

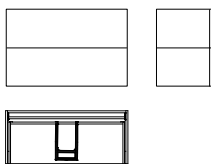

WJC780M0100110  
CREAM LIGHT MATT / CREMA LIGHT MATE



WJC780M0100116  
GREEN MATT / VERDE MATE



WJC780M0100126  
NAVY BLUE MATT / AZUL MARINO MATE



WJC780M0100108  
MATTE BLACK / NEGRO MATE

CABINET HANDLE  
TIRADOR MUEBLE

59,8X4,6X1,7 CM  
23,54X1,81X0,67 IN



WJC780M0159001  
CHROME / CROMO



WJC780M0159065  
WHITE MATT / BLANCO MATE



WJC780M0159744  
GLOSSY GOLD / ORO BRILLO



WJC780M0159036  
MATTE BLACK / NEGRO MATE

CABINET HANDLE  
TIRADOR MUEBLE

79,8X4,6X1,7 CM  
31,42X1,81X0,67 IN



WJC780M0179001  
CHROME / CROMO



WJC780M0179065  
WHITE MATT / BLANCO MATE



WJC780M0179744  
GLOSSY GOLD / ORO BRILLO



WJC780M0179036  
MATTE BLACK / NEGRO MATE



☉  
**CABINET HANDLE**  
TIRADOR MUEBLE

99,8X4,6X1,7 CM  
39,29X1,81X0,67 IN

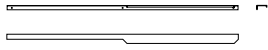

**WJC780M0199001**  
CHROME / CROMO



**WJC780M0199065**  
WHITE MATT / BLANCO MATE



**WJC780M0199744**  
GLOSSY GOLD / ORO BRILLO



**WJC780M0199036**  
MATTE BLACK / NEGRO MATE

⚙️  
**BUILT-IN WASHBAIN**  
LAVABO INTEGRADO

60X46X17 CM  
23,62X18,11X6,69 IN

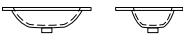

**WJC780M0260530**  
GLOSSY WHITE / BLANCO BRILLO



**WJC780M0260110**  
CREAM LIGHT MATT / CREMA LIGHT MATE



**WJC780M0260116**  
GREEN MATT / VERDE MATE



**WJC780M0260126**  
NAVY BLUE MATT / AZUL MARINO MATE



**WJC780M0260108**  
MATTE BLACK / NEGRO MATE





**BUILT-IN WASHBAIN**

LAVABO INTEGRADO

80X46X17 CM  
31,5X18,11X6,69 IN

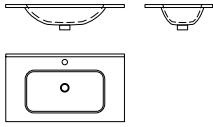

**WJC780M0280530**  
GLOSSY WHITE / BLANCO BRILLO



**WJC780M0280110**  
CREAM LIGHT MATT / CREMA LIGHT MATE



**WJC780M0280116**  
GREEN MATT / VERDE MATE



**WJC780M0280126**  
NAVY BLUE MATT / AZUL MARINO MATE



**WJC780M0280108**  
MATTE BLACK / NEGRO MATE



**BUILT-IN WASHBAIN**

LAVABO INTEGRADO

100X46X17 CM  
39,37X18,11X6,69 IN

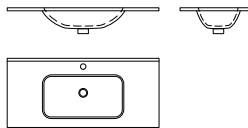

**WJC780M2100530**  
GLOSSY WHITE / BLANCO BRILLO



**WJC780M2100110**  
CREAM LIGHT MATT / CREMA LIGHT MATE



**WJC780M2100116**  
GREEN MATT / VERDE MATE



**WJC780M2100126**  
NAVY BLUE MATT / AZUL MARINO MATE



**WJC780M2100108**  
MATTE BLACK / NEGRO MATE





## BUILT-IN WASHBAIN

LAVABO INTEGRADO

120X46X17 CM  
47,24X18,11X6,69 IN

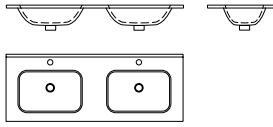

**WJC780M2120530**  
GLOSSY WHITE / BLANCO BRILLO



**WJC780M2120110**  
CREAM LIGHT MATT / CREMA LIGHT MATE



**WJC780M2120116**  
GREEN MATT / VERDE MATE



**WJC780M2120126**  
NAVY BLUE MATT / AZUL MARINO MATE



**WJC780M2120108**  
MATTE BLACK / NEGRO MATE



## BUILT-IN WASHBAIN WIHTOUT TAP HOLE

LAVABO INTEGRADO SIN AGUJERO PARA GRIFERÍA

60X46X17 CM  
23,62X18,11X6,69 IN

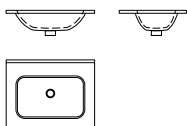

**WJC780M0360530**  
GLOSSY WHITE / BLANCO BRILLO



## BUILT-IN WASHBAIN WIHTOUT TAP HOLE

LAVABO INTEGRADO SIN AGUJERO PARA GRIFERÍA

80X46X17 CM  
31,5X18,11X6,69 IN

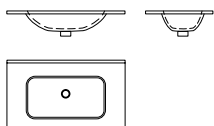

**WJC780M0380530**  
GLOSSY WHITE / BLANCO BRILLO





### BUILT-IN WASHBAIN WIHTOUT TAP HOLE

LAVABO INTEGRADO SIN AGUJERO PARA GRIFERÍA

100X46X17 CM  
39,37X18,11X6,69 IN

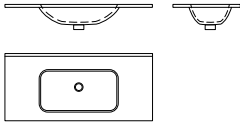

**WJC780M3100530**  
GLOSSY WHITE / BLANCO BRILLO



### BUILT-IN WASHBAIN WIHTOUT TAP HOLE

LAVABO INTEGRADO SIN AGUJERO PARA GRIFERÍA

120X46X17 CM  
47,24X18,11X6,69 IN

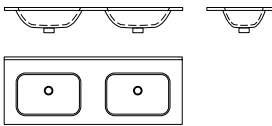

**WJC780M3120530**  
GLOSSY WHITE / BLANCO BRILLO



### COUNTERTOP WASHBASIN

LAVABO DE SOBRE-ENCIMERA

45,5X32,5X13,5 CM  
17,91X12,8X5,31 IN

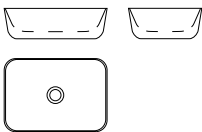

**WJC780M0146530**  
GLOSSY WHITE / BLANCO BRILLO



**WJC780M0146110**  
CREAM LIGHT MATT / CREMA LIGHT MATE



**WJC780M0146116**  
GREEN MATT / VERDE MATE



**WJC780M0146126**  
NAVY BLUE MATT / AZUL MARINO MATE



**WJC780M0146108**  
MATTE BLACK / NEGRO MATE



☼  
COUNTERTOP WASHBASIN  
LAVABO DE SOBRE-ENCIMERA

52X39,5X13 CM  
20,47X15,55X5,12 IN

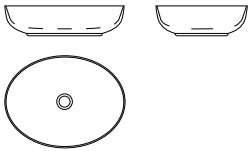

WJC780M0152530  
GLOSSY WHITE / BLANCO BRILLO



WJC780M0152110  
CREAM LIGHT MATT / CREMA LIGHT MATE



WJC780M0152116  
GREEN MATT / VERDE MATE



WJC780M0152126  
NAVY BLUE MATT / AZUL MARINO MATE



WJC780M0152108  
MATTE BLACK / NEGRO MATE

☼  
COUNTERTOP WASHBASIN  
LAVABO DE SOBRE-ENCIMERA

62X41X13,2 CM  
24,41X16,14X5,2 IN

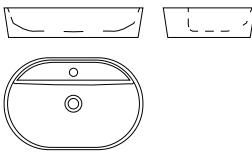

WJC780M0162530  
GLOSSY WHITE / BLANCO BRILLO



WJC780M0162110  
CREAM LIGHT MATT / CREMA LIGHT MATE



WJC780M0162116  
GREEN MATT / VERDE MATE



WJC780M0162126  
NAVY BLUE MATT / AZUL MARINO MATE



WJC780M0162108  
MATTE BLACK / NEGRO MATE



**COUNTERTOP WASHBASIN**  
LAVABO DE SOBRE-ENCIMERA

41,5X41,5X13,5 CM  
16,34X16,34X5,31 IN

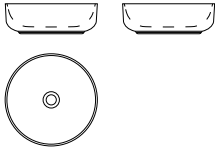

**WJC780M0142530**  
GLOSSY WHITE / BLANCO BRILLO



**WJC780M0142110**  
CREAM LIGHT MATT / CREMA LIGHT MATE



**WJC780M0142116**  
GREEN MATT / VERDE MATE



**WJC780M0142126**  
NAVY BLUE MATT / AZUL MARINO MATE



**WJC780M0142108**  
MATTE BLACK / NEGRO MATE



**VALVE CLICK CLACK**  
VÁLVULA CLICK-CLACK

7X7X10 CM  
2,76X2,76X3,94 IN

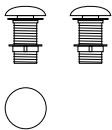

**WJC780M0007530**  
GLOSSY WHITE / BLANCO BRILLO



**WJC780M0007110**  
CREAM LIGHT MATT / CREMA LIGHT MATE



**WJC780M0007116**  
GREEN MATT / VERDE MATE



**WJC780M0007126**  
NAVY BLUE MATT / AZUL MARINO MATE



**WJC780M0007108**  
MATTE BLACK / NEGRO MATE



©  
COUNTERTOP  
ENCIMERA  
60X46X1,5 CM  
23,62X18,11X0,59 IN



**WJC780M0160102**  
WHITE MATT MARBLE / BLANCO MATE



**WJC780M0160110**  
CREAM LIGHT MATT / CREMA LIGHT MATE



**WJC780M0160116**  
GREEN MATT / VERDE MATE



**WJC780M0160126**  
NAVY BLUE MATT / AZUL MARINO MATE



**WJC780M0160108**  
MATTE BLACK / NEGRO MATE



**WJC780M0160205**  
WHITE MATT MARBLE CALACATTA / MARMOL CALACATTA MATE



**WJC780M0160241**  
BLACK MATT MARBLE MARGUINA / MARMOL MARGUINA MATE

©  
COUNTERTOP  
ENCIMERA  
80X46X1,5 CM  
31,5X18,11X0,59 IN



**WJC780M0180102**  
WHITE MATT MARBLE / BLANCO MATE



**WJC780M0180110**  
CREAM LIGHT MATT / CREMA LIGHT MATE



**WJC780M0180116**  
GREEN MATT / VERDE MATE



**WJC780M0180126**  
NAVY BLUE MATT / AZUL MARINO MATE



**WJC780M0180108**  
MATTE BLACK / NEGRO MATE



**WJC780M0180205**  
WHITE MATT MARBLE CALACATTA / MARMOL CALACATTA MATE



**WJC780M0180241**  
BLACK MATT MARBLE MARGUINA / MARMOL MARGUINA MATE



©  
COUNTERTOP  
ENCIMERA  
100X46X1,5 CM  
39,37X18,11X0,59 IN



WJC780M1100102  
WHITE MATT MARBLE / BLANCO  
MATE

WJC780M1100110  
CREAM LIGHT MATT / CREMA LIGHT  
MATE

WJC780M1100116  
GREEN MATT / VERDE MATE

WJC780M1100126  
NAVY BLUE MATT / AZUL MARINO  
MATE



WJC780M1100108  
MATTE BLACK / NEGRO MATE

WJC780M1100205  
WHITE MATT MARBLE CALACATTA /  
MARMOL CALACATTA MATE

WJC780M1100241  
BLACK MATT MARBLE MARGUINA /  
MARMOL MARGUINA MATE

©  
COUNTERTOP  
ENCIMERA  
120X46X1,5 CM  
47,24X18,11X0,59 IN



WJC780M1120102  
WHITE MATT MARBLE / BLANCO  
MATE

WJC780M1120110  
CREAM LIGHT MATT / CREMA LIGHT  
MATE

WJC780M1120116  
GREEN MATT / VERDE MATE

WJC780M1120126  
NAVY BLUE MATT / AZUL MARINO  
MATE



WJC780M1120108  
MATTE BLACK / NEGRO MATE

WJC780M1120205  
WHITE MATT MARBLE CALACATTA /  
MARMOL CALACATTA MATE

WJC780M1120241  
BLACK MATT MARBLE MARGUINA /  
MARMOL MARGUINA MATE



Wish



©  
**COUNTERTOP**  
ENCIMERA  
160X46X1.5 CM  
62,99X18,11X0,59 IN

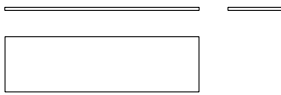

**WJC780M1160102**  
WHITE MATT MARBLE / BLANCO  
MATE

**WJC780M1160110**  
CREAM LIGHT MATT / CREMA LIGHT  
MATE

**WJC780M1160116**  
GREEN MATT / VERDE MATE

**WJC780M1160126**  
NAVY BLUE MATT / AZUL MARINO  
MATE



**WJC780M1160108**  
MATTE BLACK / NEGRO MATE

**WJC780M1160205**  
WHITE MATT MARBLE CALACATTA /  
MARMOL CALACATTA MATE

**WJC780M1160241**  
BLACK MATT MARBLE MARGUINA /  
MARMOL MARGUINA MATE

◇  
**MIRROR**  
ESPEJO  
60X2,3X60 CM  
23,62X0,91X23,62 IN



**WJC780M0001740**  
GOLD MATT / ORO MATE



**WJC780M0001108**  
MATTE BLACK / NEGRO MATE

◇  
**MIRROR**  
ESPEJO  
80X2,3X80 CM  
31,5X0,91X31,5 IN



**WJC780M0002740**  
GOLD MATT / ORO MATE

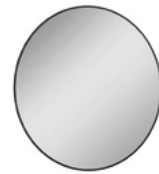

**WJC780M0002108**  
MATTE BLACK / NEGRO MATE

◇  
**MIRROR**  
ESPEJO  
100X2,3X100 CM  
39,37X0,91X39,37 IN



**WJC780M0003740**  
GOLD MATT / ORO MATE

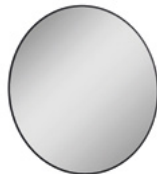

**WJC780M0003108**  
MATTE BLACK / NEGRO MATE

◇  
**LED LIGHTING  
MIRROR**  
ESPEJO CON LUZ  
LED  
60X2,5X60 CM  
23,62X0,98X23,62 IN



**WJC780M0004740**  
GOLD MATT / ORO MATE

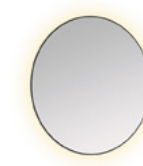

**WJC780M0004108**  
MATTE BLACK / NEGRO MATE



◆  
**LED LIGHTING MIRROR**  
ESPEJO CON LUZ LED  
80X2,5X80 CM  
31,5X0,98X31,5 IN



**WJC780M0005740**  
GOLD MATT / ORO MATE



**WJC780M0005108**  
MATTE BLACK / NEGRO MATE

◆  
**LED LIGHTING MIRROR**  
ESPEJO CON LUZ LED  
100X2,5X100 CM  
39,37X0,98X39,37 IN



**WJC780M0006740**  
GOLD MATT / ORO MATE



**WJC780M0006108**  
MATTE BLACK / NEGRO MATE



# Mod

Design by **Cosmic Studio**







PVC finish in Mocha and Matte White.

Acabados en PVC en Mocca y Blanco mate.



Large pieces, 55cm deep and 50cm tall. 2-drawer washbasin models available in 60, 80 and 100cm, which can be combined with 40cm additional modules with 1 door (opening to the right or left). Easy wall fixing & adjustable attachment systems.

Muebles amplios, con profundidad de 55 cm y altura de 50 cm. Módulos de 2 cajones para lavabo de 60, 80 y 100 cm, que se pueden combinar con módulos auxiliares de 40 cm con 1 puerta (a izquierda o derecha). Fácil anclaje a pared y sistemas de fijación regulables.



Units include an optional storage systems such as containers, dividers and a hanging wastebaskets.

Módulos que integran sistemas opcionales de almacenaje y orden como containers, separadores y papelera.

Rectangular single or double sink in glossy white finish, with overflow. Made with Solid Surface, with no mineral additives, which offers more flexibility when creating different shapes and surfaces. Its properties include excellent shock resistance and UVB resistance. In addition, its colour remains unalterable for years, without yellowing. It is also resistant to marks from some cosmetic and beauty products.

Lavabos de uno o dos senos de forma rectangular y en acabado blanco brillo, con rebosadero. Fabricados en Solid Surface sin aditivos minerales que da al producto una mayor flexibilidad en la creación de formas y superficies. Entre sus peculiaridades destaca que tiene una excelente resistencia al impacto y a los rayos UVB y que mantiene su color original a lo largo de los años, sin amarillear. Es resistente a la absorción de ciertos cosméticos y productos de belleza.



The drawers, with a handle, are completely removable to let the most pleasant use. The front parts of the doors do not have handles thanks to the Touch Latch Senso® (Push-Open) opening system.

Los cajones, con tirador integrado, se extraen totalmente permitiendo un uso más cómodo. Los frontales de los muebles están libres de tiradores gracias al sistema de apertura Touch Latch Senso® (Push-Open).

Eco friendly: furniture made in Spain with certified wood board following the chain of custody in forestry. High quality laminate.

Producto ambientalmente responsable: muebles fabricados en España con tableros de madera certificada conforme la cadena de custodia de productos forestales. Acabados laminados de alta gama.



Self & soft close with new rail system which can be completely removed. The long lasting durability of drawers is assured by quality control tests (up to 20,000 times).

Apertura y cierre amortiguado con guías de extracción total ocultas soft & self close. La durabilidad de los cajones está asegurada ya que han superado con éxito hasta 20.000 ciclos en los test de control de calidad.

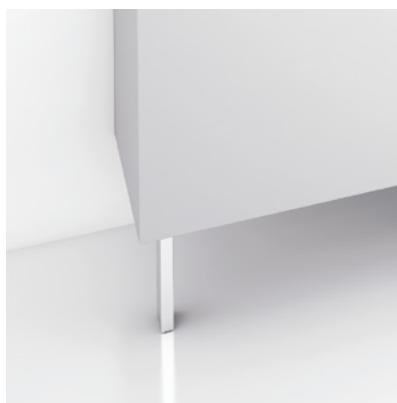

Leg set (optional).

Patas opcionales.

**Mod** has successfully passed the high demanding tests of long-lasting durability and resistance to extreme uses (static charge or impact testing) to assure long-lasting durability of the product.

Toda la gama **Mod** ha superado con éxito exigentes tests de durabilidad y resistencia a usos extremos (cargas estáticas o test de impacto), para asegurar una larga vida al producto.





## SET OF 2 LEGS

JUEGO DE DOS 2 PATAS

6X3,5X34,1 CM  
2,36X1,38X13,43 IN

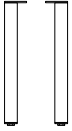

**WJM341R0726000**  
CHROME / CROMO



## 2-DRAWER CABINET & GLOSSY WASHBASIN

MUEBLE 2 CAJONES LAVABO BRILLO

60,5X55X52,5 CM  
23,82X21,65X20,67 IN

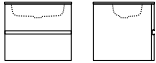

**WJC748M0013129**  
PVC MATTE WHITE / PVC BLANCO  
MATE

**WJC748M0013200**  
MOCCA PVC / PVC MOCCA



## 2-DRAWER CABINET & GLOSSY WASHBASIN

MUEBLE 2 CAJONES LAVABO BRILLO

80,5X55X52,5 CM  
31,69X21,65X20,67 IN

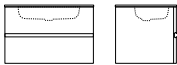

**WJC748M0014129**  
PVC MATTE WHITE / PVC BLANCO  
MATE

**WJC748M0014200**  
MOCCA PVC / PVC MOCCA



## 2-DRAWER CABINET & GLOSSY WASHBASIN

MUEBLE 2 CAJONES LAVABO BRILLO

100,5X55X52,5 CM  
39,57X21,65X20,67 IN

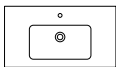

**WJC748M0015129**  
PVC MATTE WHITE / PVC BLANCO  
MATE

**WJC748M0015200**  
MOCCA PVC / PVC MOCCA





**2-DRAWERS & 1 DOOR CABINET WITH GLOSSY  
RIGHT-SINK WASHBASIN**

MUEBLE 2 CAJONES Y 1 PUERTA CON LAVABO  
BRILLO SENO DERECHA

100,5X55X52,5 CM  
39,57X21,65X20,67 IN

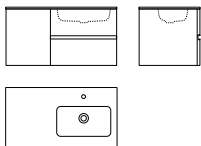

**WJC748M0016129**  
PVC MATTE WHITE / PVC BLANCO  
MATE



**WJC748M0016200**  
MOCCA PVC / PVC MOCCA



**2-DRAWERS & 1 DOOR CABINET WITH GLOSSY  
RIGHT-SINK WASHBASIN**

MUEBLE 2 CAJONES Y 1 PUERTA CON LAVABO  
BRILLO SENO DERECHA

120,5X55X52,5 CM  
47,44X21,65X20,67 IN

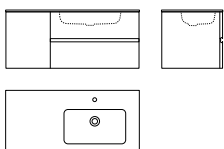

**WJC748M0019129**  
PVC MATTE WHITE / PVC BLANCO  
MATE



**WJC748M0019200**  
MOCCA PVC / PVC MOCCA



**2-DRAWERS & 1 DOOR CABINET WITH GLOSSY  
RIGHT-SINK WASHBASIN**

MUEBLE 2 CAJONES Y 1 PUERTA CON LAVABO  
BRILLO SENO DERECHA

140,5X55X52,5 CM  
55,31X21,65X20,67 IN

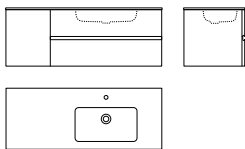

**WJC748M0021129**  
PVC MATTE WHITE / PVC BLANCO  
MATE



**WJC748M0021200**  
MOCCA PVC / PVC MOCCA



**2-DRAWERS & 1 DOOR CABINET WITH GLOSSY  
LEFT-SINK WASHBASIN**

MUEBLE 2 CAJONES Y 1 PUERTA CON LAVABO  
BRILLO SENO IZQUIERDA

100,5X55X52,5 CM  
39,57X21,65X20,67 IN

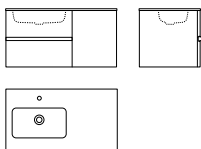

**WJC748M0017129**  
PVC MATTE WHITE / PVC BLANCO  
MATE



**WJC748M0017200**  
MOCCA PVC / PVC MOCCA





## 2-DRAWERS & 1 DOOR CABINET WITH GLOSSY LEFT-SINK WASHBASIN

MUEBLE 2 CAJONES Y 1 PUERTA CON LAVABO BRILLO SENO IZQUIERDA

120,5X55X52,5 CM  
47,44X21,65X20,67 IN

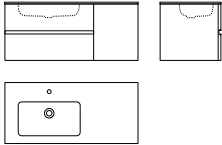

**WJC748M0020129**  
PVC MATTE WHITE / PVC BLANCO  
MATE



**WJC748M0020200**  
MOCCA PVC / PVC MOCCA



## 2-DRAWERS & 1 DOOR CABINET WITH GLOSSY LEFT-SINK WASHBASIN

MUEBLE 2 CAJONES Y 1 PUERTA CON LAVABO BRILLO SENO IZQUIERDA

140,5X55X52,5 CM  
55,31X21,65X20,67 IN

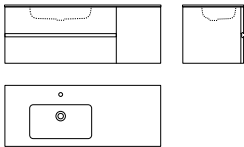

**WJC748M0022129**  
PVC MATTE WHITE / PVC BLANCO  
MATE



**WJC748M0022200**  
MOCCA PVC / PVC MOCCA



## 4-DRAWERS CABINET WITH GLOSSY & DOUBLE SINKED WASHBASIN

MUEBLE 4 CAJONES CON LAVABO BRILLO 2 SENOS

120,5X55X52,5 CM  
47,44X21,65X20,67 IN

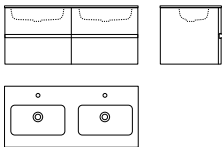

**WJC748M0018129**  
PVC MATTE WHITE / PVC BLANCO  
MATE



**WJC748M0018200**  
MOCCA PVC / PVC MOCCA



## 4-DRAWERS CABINET WITH GLOSSY & DOUBLE SINKED WASHBASIN

MUEBLE 4 CAJONES CON LAVABO BRILLO 2 SENOS

160,5X55X52,5 CM  
63,19X21,65X20,67 IN

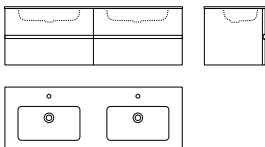

**WJC748M0023129**  
PVC MATTE WHITE / PVC BLANCO  
MATE



**WJC748M0023200**  
MOCCA PVC / PVC MOCCA





**4-DRAWERS CABINET WITH GLOSSY & DOUBLE SINKED WASHBASIN**

MUEBLE 4 CAJONES CON LAVABO BRILLO 2 SENOS

200,5X55X52,5 CM  
78,94X21,65X20,67 IN

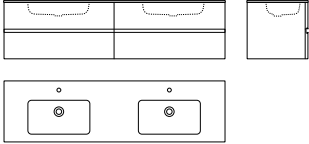

**WJC748M0024129**  
PVC MATTE WHITE / PVC BLANCO MATE

**WJC748M0024200**  
MOCCA PVC / PVC MOCCA



**VALVE**

VALVULA CLICK-CLACK

6,2X6,2X8,4 CM  
2,44X2,44X3,31 IN



**WJC341R0387000**  
CHROME / CROMO



**WJC341R0789000**  
MATTE WHITE / BLANCO MATE



**WJC341R0790000**  
MATTE BLACK / NEGRO MATE



# B-Best

Design by **Jaume Juan**





NEW  
FINISH



NEW  
FINISH  
MATT







NEW  
**FINISH**  
MATT





B-Best is a furniture collection with washbasin designed for people who seek the comfort and functionality of everyday's life: the frenetic rhythms of life, the morning rush, and moments of relaxation at the end of the day; without forgetting design and aesthetics. People who perceive functionality in simplicity and minimalism, and beauty in order and harmony.

A collection with 6 finishes to choose from, so that your bathroom is completely yours.

B-Best es una colección de mobiliario con lavabo pensada para personas que buscan la comodidad y practicidad del día a día: de los ritmos de vida frenéticos, las prisas de la mañana, y los momentos de relax al final del día; sin dejar de lado el diseño y la estética. Personas que perciben la funcionalidad en la sencillez y el minimalismo, y la belleza en el orden y la armonía.

Una colección que cuenta con 6 acabados a escoger, para que tu baño sea tuyo.



When centimetres count, you don't have to give up design and functionality. With B-Best you can choose between 4 models of furniture and 2 washbasins, in different sizes to suit you and your needs.

Cuando los centímetros cuentan, no tienes por qué renunciar al diseño y funcionalidad. Con B-Best puedes escoger entre 4 modelos de muebles y 2 lavabos, de tamaños diferentes que se adaptan a ti y a tus necesidades.

Washbasins in different shapes and materials and up to 4 furniture models of 60, 80, 100 or 120 cm with a casual design: rectangular basin in porcelain and rectangular basin in teckstone with a space for accessories.

Lavabos de formas y materiales diferentes y hasta 4 modelos de mobiliario de 60, 80, 100 o 120 cm con un diseño desenfadado: seno rectangular en porcelana y seno rectangular en teckstone con un espacio destinado a los accesorios.



FSC Certified products

Productos certificados FSC.



○

## HOOK

COLGADOR

25X4,3X5,1 CM  
0,98X1,69X2,01 IN

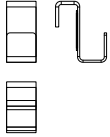

WJB005A0102002  
BRIGHT / INOX BRILLO

**INCLUDED  
IN EACH  
CABINET**  
**GRATIS  
EN CADA  
MUEBLE**



■✿

## 1 DRAWER AND 1 DECORATIVE CABINET WITH PORCELAIN WASHBASIN

MUEBLE 1 CAJÓN Y 1 DECORATIVO CON LAVABO DE PORCELANA

60X45,5X61,5 CM  
23,62X17,91X24,21 IN

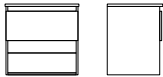

**NEW** WJB010P1615102  
MATT WHITE / BLANCO MATE



WJB010P1615229  
GLOSSY WHITE / BLANCO BRILLO



**NEW** WJB010P1615194  
NATURAL OAK / ROBLE NATURAL



WJB010P1615232  
NATURAL WALNUT / NOGAL NATURAL

■✿

## 1 DRAWER AND 1 DECORATIVE CABINET WITH PORCELAIN WASHBASIN

MUEBLE 1 CAJÓN Y 1 DECORATIVO CON LAVABO DE PORCELANA

80X45,5X61,5 CM  
31,5X17,91X24,21 IN

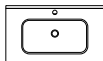
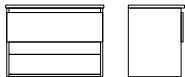

**NEW** WJB010P1815102  
MATT WHITE / BLANCO MATE



WJB010P1815229  
GLOSSY WHITE / BLANCO BRILLO



**NEW** WJB010P1815194  
NATURAL OAK / ROBLE NATURAL



WJB010P1815232  
NATURAL WALNUT / NOGAL NATURAL

■✿

## 1 DRAWER AND 1 DECORATIVE CABINET WITH PORCELAIN WASHBASIN

MUEBLE 1 CAJÓN Y 1 DECORATIVO CON LAVABO DE PORCELANA

100X45,5X61,5 CM  
39,37X17,91X24,21 IN

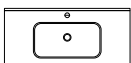
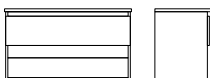

**NEW** WJB010P1015102  
MATT WHITE / BLANCO MATE



WJB010P1015229  
GLOSSY WHITE / BLANCO BRILLO



**NEW** WJB010P1015194  
NATURAL OAK / ROBLE NATURAL



WJB010P1015232  
NATURAL WALNUT / NOGAL NATURAL



2 DRAWER AND 2 DECORATIVE CABINET WITH PORCELAIN WASHBASIN

MUEBLE 2 CAJONES Y 2 DECORATIVOS CON LAVABO DE PORCELANA

120X45,5X61,5 CM  
47,24X17,91X24,21 IN

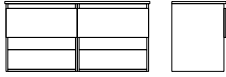

**NEW** WJB010P2215102  
MATT WHITE / BLANCO MATE



WJB010P2215229  
GLOSSY WHITE / BLANCO BRILLO



**NEW** WJB010P2215194  
NATURAL OAK / ROBLE NATURAL



WJB010P2215232  
NATURAL WALNUT / NOGAL NATURAL

2 DRAWER CABINET WITH PORCELAIN WASHBASIN

MUEBLE 2 CAJONES CON LAVABO DE PORCELANA

60X45,5X61,5 CM  
23,62X17,91X24,21 IN

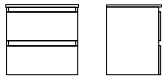

**NEW** WJB010P0615102  
MATT WHITE / BLANCO MATE



WJB010P0615229  
GLOSSY WHITE / BLANCO BRILLO



**NEW** WJB010P0615194  
NATURAL OAK / ROBLE NATURAL



WJB010P0615232  
NATURAL WALNUT / NOGAL NATURAL

2 DRAWER CABINET WITH PORCELAIN WASHBASIN

MUEBLE 2 CAJONES CON LAVABO DE PORCELANA

80X45,5X61,5 CM  
31,5X17,91X24,21 IN

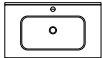
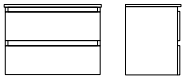

**NEW** WJB010P2815102  
MATT WHITE / BLANCO MATE



WJB010P2815229  
GLOSSY WHITE / BLANCO BRILLO



**NEW** WJB010P2815194  
NATURAL OAK / ROBLE NATURAL



WJB010P2815232  
NATURAL WALNUT / NOGAL NATURAL

2 DRAWER CABINET WITH PORCELAIN WASHBASIN

MUEBLE 2 CAJONES CON LAVABO DE PORCELANA

100X45,5X61,5 CM  
39,37X17,91X24,21 IN

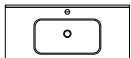
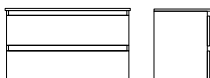

**NEW** WJB010P2015102  
MATT WHITE / BLANCO MATE



WJB010P2015229  
GLOSSY WHITE / BLANCO BRILLO



**NEW** WJB010P2015194  
NATURAL OAK / ROBLE NATURAL



WJB010P2015232  
NATURAL WALNUT / NOGAL NATURAL





**3 DRAWER CABINET WITH LEGS WITH PORCELAIN WASHBASIN**  
MUEBLE 3 CAJONES CON PATAS CON LAVABO DE PORCELANA

80X45,5X61,5 CM  
31,5X17,91X24,21 IN

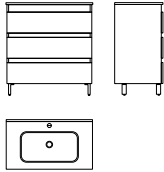

**NEW** WJB010P3815102  
MATT WHITE / BLANCO MATE



WJB010P3815229  
GLOSSY WHITE / BLANCO BRILLO



**NEW** WJB010P3815194  
NATURAL OAK / ROBLE NATURAL



WJB010P3815232  
NATURAL WALNUT / NOGAL NATURAL



**3 DRAWER CABINET WITH LEGS WITH PORCELAIN WASHBASIN**  
MUEBLE 3 CAJONES CON PATAS CON LAVABO DE PORCELANA

100X45,5X61,5 CM  
39,37X17,91X24,21 IN

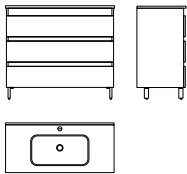

**NEW** WJB010P3015102  
MATT WHITE / BLANCO MATE



WJB010P3015229  
GLOSSY WHITE / BLANCO BRILLO



**NEW** WJB010P3015194  
NATURAL OAK / ROBLE NATURAL



WJB010P3015232  
NATURAL WALNUT / NOGAL NATURAL



**4 DRAWER CABINET WITH PORCELAIN WASHBASIN**  
MUEBLE 4 CAJONES CON LAVABO DE PORCELANA

120X45,5X61,5 CM  
47,24X17,91X24,21 IN

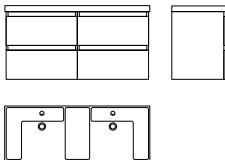

**NEW** WJB010P1215102  
MATT WHITE / BLANCO MATE



WJB010P1215229  
GLOSSY WHITE / BLANCO BRILLO



**NEW** WJB010P1215194  
NATURAL OAK / ROBLE NATURAL



WJB010P1215232  
NATURAL WALNUT / NOGAL NATURAL





PACK 1 DRAWER 1  
SHELF CABINET +  
PORCELAIN + MIRROR  
+ WALL LAMP

PACK MUEBLE 1 CAJON  
Y 1 DECORATIVO +  
PORCELANA + ESPEJO  
+ APLIQUE

60X45,5X61,5 CM  
23,62X17,91X24,21 IN



**NEW** WJB010P0611102  
MATT WHITE / BLANCO MATE



WJB010P0611229  
GLOSSY WHITE / BLANCO BRILLO



**NEW** WJB010P0611194  
NATURAL OAK / ROBLE NATURAL



WJB010P0611232  
NATURAL WALNUT / NOGAL NATURAL



PACK 1 DRAWER 1  
SHELF CABINET +  
PORCELAIN + MIRROR  
+ WALL LAMP

PACK MUEBLE 1 CAJON  
Y 1 DECORATIVO +  
PORCELANA + ESPEJO  
+ APLIQUE

80X45,5X61,5 CM  
31,5X17,91X24,21 IN



**NEW** WJB010P0811102  
MATT WHITE / BLANCO MATE



WJB010P0811229  
GLOSSY WHITE / BLANCO BRILLO



**NEW** WJB010P0811194  
NATURAL OAK / ROBLE NATURAL



WJB010P0811232  
NATURAL WALNUT / NOGAL NATURAL





PACK 1 DRAWER 1  
SHELF CABINET +  
PORCELAIN + MIRROR  
+ WALL LAMP

PACK MUEBLE 1 CAJON  
Y 1 DECORATIVO +  
PORCELANA + ESPEJO  
+ APLIQUE

100X45,5X61,5 CM  
39,37X17,91X24,21 IN



**NEW** WJB010P1012102  
MATT WHITE / BLANCO MATE

WJB010P1012229  
GLOSSY WHITE / BLANCO BRILLO

**NEW** WJB010P1012194  
NATURAL OAK / ROBLE NATURAL

WJB010P1012232  
NATURAL WALNUT / NOGAL NATURAL



PACK 2 DRAWER 2  
SHELF CABINET +  
PORCELAIN + MIRROR  
+ WALL LAMP

PACK MUEBLE  
2 CAJON Y 2  
DECORATIVO +  
PORCELANA + ESPEJO  
+ APLIQUE

120X45,5X61,5 CM  
47,24X17,91X24,21 IN



**NEW** WJB010P1212102  
MATT WHITE / BLANCO MATE

WJB010P1212229  
GLOSSY WHITE / BLANCO BRILLO

**NEW** WJB010P1212194  
NATURAL OAK / ROBLE NATURAL

WJB010P1212232  
NATURAL WALNUT / NOGAL NATURAL





PACK 2 DRAWER  
CABINET + PORCELAIN  
+ MIRROR + WALL  
LAMP

PACK MUEBLE  
2 CAJONES +  
PORCELANA + ESPEJO  
+ APLIQUE

60X45,5X61,5 CM  
23,62X17,91X24,21 IN



**NEW** WJB010P0610102  
MATT WHITE / BLANCO MATE



WJB010P0610229  
GLOSSY WHITE / BLANCO BRILLO



**NEW** WJB010P0610194  
NATURAL OAK / ROBLE NATURAL



WJB010P0610232  
NATURAL WALNUT / NOGAL NATURAL



PACK 2 DRAWER  
CABINET + PORCELAIN  
+ MIRROR + WALL  
LAMP

PACK MUEBLE  
2 CAJONES +  
PORCELANA + ESPEJO  
+ APLIQUE

80X45,5X61,5 CM  
31,5X17,91X24,21 IN



**NEW** WJB010P0810102  
MATT WHITE / BLANCO MATE



WJB010P0810229  
GLOSSY WHITE / BLANCO BRILLO



**NEW** WJB010P0810194  
NATURAL OAK / ROBLE NATURAL



WJB010P0810232  
NATURAL WALNUT / NOGAL NATURAL





PACK 2 DRAWER  
CABINET + PORCELAIN  
+ MIRROR + WALL  
LAMP

PACK MUEBLE  
2 CAJONES +  
PORCELANA + ESPEJO  
+ APLIQUE

100X45,5X61,5 CM  
39,37X17,91X24,21 IN



**NEW** WJB010P1011102  
MATT WHITE / BLANCO MATE



WJB010P1011229  
GLOSSY WHITE / BLANCO BRILLO



**NEW** WJB010P1011194  
NATURAL OAK / ROBLE NATURAL



WJB010P1011232  
NATURAL WALNUT / NOGAL NATURAL



PACK 3 DRAWER  
CABINET + PORCELAIN  
+ MIRROR + WALL  
LAMP

PACK MUEBLE  
3 CAJONES +  
PORCELANA + ESPEJO  
+ APLIQUE

80X45,5X61,5 CM  
31,5X17,91X24,21 IN



**NEW** WJB010P0812102  
MATT WHITE / BLANCO MATE



WJB010P0812229  
GLOSSY WHITE / BLANCO BRILLO



**NEW** WJB010P0812194  
NATURAL OAK / ROBLE NATURAL



WJB010P0812232  
NATURAL WALNUT / NOGAL NATURAL





PACK 3 DRAWER  
CABINET + PORCELAIN  
+ MIRROR + WALL  
LAMP

PACK MUEBLE  
3 CAJONES +  
PORCELANA + ESPEJO  
+ APLIQUE

100X45,5X61,5 CM  
39,37X17,91X24,21 IN



**NEW** WJB010P1013102  
MATT WHITE / BLANCO MATE



WJB010P1013229  
GLOSSY WHITE / BLANCO BRILLO



**NEW** WJB010P1013194  
NATURAL OAK / ROBLE NATURAL



WJB010P1013232  
NATURAL WALNUT / NOGAL NATURAL



PACK 4 DRAWER  
CABINET + PORCELAIN  
+ MIRROR + WALL LAM

PACK MUEBLE  
4 CAJONES +  
PORCELANA + ESPEJO  
+ APLIQUE

120X45,5X61,5 CM  
47,24X17,91X24,21 IN



**NEW** WJB010P1211102  
MATT WHITE / BLANCO MATE



WJB010P1211229  
GLOSSY WHITE / BLANCO BRILLO



**NEW** WJB010P1211194  
NATURAL OAK / ROBLE NATURAL



WJB010P1211232  
NATURAL WALNUT / NOGAL NATURAL





**1 DRAWER AND 1 DECORATIVE CABINET WITH TECKSTONE WASHBASIN**  
MUEBLE 1 CAJÓN Y 1 DECORATIVO CON LAVABO TECKSTONE

60X45,5X61,5 CM  
23,62X17,91X24,21 IN

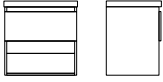

**NEW** WJB010P0601102  
MATT WHITE / BLANCO MATE



WJB010P0601229  
GLOSSY WHITE / BLANCO BRILLO



**NEW** WJB010P0601194  
NATURAL OAK / ROBLE NATURAL



WJB010P0601232  
NATURAL WALNUT / NOGAL NATURAL



**1 DRAWER AND 1 DECORATIVE CABINET WITH TECKSTONE WASHBASIN**  
MUEBLE 1 CAJÓN Y 1 DECORATIVO CON LAVABO TECKSTONE

80X45,5X61,5 CM  
31,5X17,91X24,21 IN

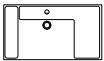
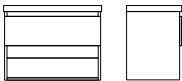

**NEW** WJB010P1801102  
MATT WHITE / BLANCO MATE



WJB010P1801229  
GLOSSY WHITE / BLANCO BRILLO



**NEW** WJB010P1801194  
NATURAL OAK / ROBLE NATURAL



WJB010P1801232  
NATURAL WALNUT / NOGAL NATURAL



**1 DRAWER AND 1 DECORATIVE CABINET WITH TECKSTONE WASHBASIN**  
MUEBLE 1 CAJÓN Y 1 DECORATIVO CON LAVABO TECKSTONE

100X45,5X61,5 CM  
39,37X17,91X24,21 IN

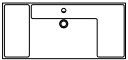
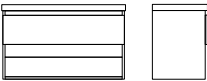

**NEW** WJB010P1001102  
MATT WHITE / BLANCO MATE



WJB010P1001229  
GLOSSY WHITE / BLANCO BRILLO



**NEW** WJB010P1001194  
NATURAL OAK / ROBLE NATURAL



WJB010P1001232  
NATURAL WALNUT / NOGAL NATURAL



**2 DRAWER AND 2 DECORATIVE CABINET WITH TECKSTONE WASHBASIN**  
MUEBLE 2 CAJONES Y 2 DECORATIVOS CON LAVABO TECKSTONE

120X45,5X61,5 CM  
47,24X17,91X24,21 IN



**NEW** WJB010P2201102  
MATT WHITE / BLANCO MATE



WJB010P2201229  
GLOSSY WHITE / BLANCO BRILLO



**NEW** WJB010P2201194  
NATURAL OAK / ROBLE NATURAL



WJB010P2201232  
NATURAL WALNUT / NOGAL NATURAL





### 2 DRAWER CABINET WITH TECKSTONE WASHBASIN

MUEBLE 2 CAJONES CON LAVABO TECKSTONE

60X45,5X61,5 CM  
23,62X17,91X24,21 IN

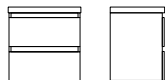

**NEW** WJB010P2601102  
MATT WHITE / BLANCO MATE



WJB010P2601229  
GLOSSY WHITE / BLANCO BRILLO



**NEW** WJB010P2601194  
NATURAL OAK / ROBLE NATURAL



WJB010P2601232  
NATURAL WALNUT / NOGAL NATURAL



### 2 DRAWER CABINET WITH TECKSTONE WASHBASIN

MUEBLE 2 CAJONES CON LAVABO TECKSTONE

80X45,5X61,5 CM  
31,5X17,91X24,21 IN

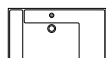
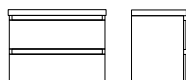

**NEW** WJB010P2801102  
MATT WHITE / BLANCO MATE



WJB010P2801229  
GLOSSY WHITE / BLANCO BRILLO



**NEW** WJB010P2801194  
NATURAL OAK / ROBLE NATURAL



WJB010P2801232  
NATURAL WALNUT / NOGAL NATURAL



### 2 DRAWER CABINET WITH TECKSTONE WASHBASIN

MUEBLE 2 CAJONES CON LAVABO TECKSTONE

100X45,5X61,5 CM  
39,37X17,91X24,21 IN

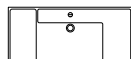
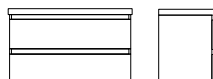

**NEW** WJB010P2001102  
MATT WHITE / BLANCO MATE



WJB010P2001229  
GLOSSY WHITE / BLANCO BRILLO



**NEW** WJB010P2001194  
NATURAL OAK / ROBLE NATURAL



WJB010P2001232  
NATURAL WALNUT / NOGAL NATURAL



### 4 DRAWER CABINET WITH TECKSTONE WASHBASIN

MUEBLE 4 CAJONES CON LAVABO TECKSTONE

120X45,5X61,5 CM  
47,24X17,91X24,21 IN

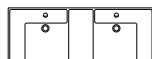
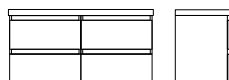

**NEW** WJB010P1201102  
MATT WHITE / BLANCO MATE



WJB010P1201229  
GLOSSY WHITE / BLANCO BRILLO



**NEW** WJB010P1201194  
NATURAL OAK / ROBLE NATURAL



WJB010P1201232  
NATURAL WALNUT / NOGAL NATURAL





**CABINET 3 DRAWERS WITH LEGS WITH TECKSTONE WASHBASIN**  
MUEBLE 3 CAJONES CON PATAS CON LAVABO TECKSTONE

80X45,5X61,5 CM  
31,5X17,91X24,21 IN

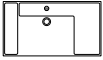
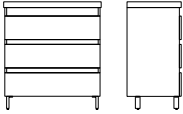

**NEW** WJB010P3801102  
MATT WHITE / BLANCO MATE



WJB010P3801229  
GLOSSY WHITE / BLANCO BRILLO



**NEW** WJB010P3801194  
NATURAL OAK / ROBLE NATURAL



WJB010P3801232  
NATURAL WALNUT / NOGAL NATURAL



**CABINET 3 DRAWERS WITH LEGS WITH TECKSTONE WASHBASIN**  
MUEBLE 3 CAJONES CON PATAS CON LAVABO TECKSTONE

100X45,5X61,5 CM  
39,37X17,91X24,21 IN

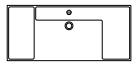
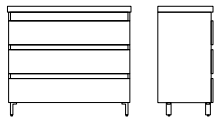

**NEW** WJB010P3001102  
MATT WHITE / BLANCO MATE



WJB010P3001229  
GLOSSY WHITE / BLANCO BRILLO



**NEW** WJB010P3001194  
NATURAL OAK / ROBLE NATURAL



WJB010P3001232  
NATURAL WALNUT / NOGAL NATURAL



**PACK 1 DRAWER 1 SHELF CABINET + TECKSTONE + MIRROR + WALL LAMP**  
PACK MUEBLE 1 CAJON Y 1 DECORATIVO + TECKSTONE + ESPEJO + APLIQUE

60X45,5X61,5 CM  
23,62X17,91X24,21 IN



**NEW** WJB010P6100102  
MATT WHITE / BLANCO MATE



WJB010P6100229  
GLOSSY WHITE / BLANCO BRILLO



**NEW** WJB010P6100194  
NATURAL OAK / ROBLE NATURAL



WJB010P6100232  
NATURAL WALNUT / NOGAL NATURAL





PACK 1 DRAWER 1  
SHELF CABINET +  
TECKSTONE + MIRROR  
+ WALL LAMP

PACK MUEBLE 1 CAJON  
Y 1 DECORATIVO +  
TECKSTONE + ESPEJO  
+ APLIQUE

80X45,5X61,5 CM  
31,5X17,9X24,21 IN



**NEW** WJB010P8100102  
MATT WHITE / BLANCO MATE



WJB010P8100229  
GLOSSY WHITE / BLANCO BRILLO



**NEW** WJB010P8100194  
NATURAL OAK / ROBLE NATURAL



WJB010P8100232  
NATURAL WALNUT / NOGAL NATURAL



PACK 1 DRAWER 1  
SHELF CABINET +  
TECKSTONE + MIRROR  
+ WALL LAMP

PACK MUEBLE 1 CAJON  
Y 1 DECORATIVO +  
TECKSTONE + ESPEJO  
+ APLIQUE

100X45,5X61,5 CM  
39,57X17,9X24,21 IN



**NEW** WJB010P0100102  
MATT WHITE / BLANCO MATE



WJB010P0100229  
GLOSSY WHITE / BLANCO BRILLO



**NEW** WJB010P0100194  
NATURAL OAK / ROBLE NATURAL



WJB010P0100232  
NATURAL WALNUT / NOGAL NATURAL





PACK 2 DRAWER 2  
SHELF CABINET +  
TECKSTONE + MIRROR  
+ WALL LAMP

PACK MUEBLE  
2 CAJON Y 2  
DECORATIVO +  
TECKSTONE + ESPEJO  
+ APLIQUE

120X45,5X61,5 CM  
47,24X17,91X24,21 IN



**NEW** WJB010P2100102  
MATT WHITE / BLANCO MATE

WJB010P2100229  
GLOSSY WHITE / BLANCO BRILLO

**NEW** WJB010P2100194  
NATURAL OAK / ROBLE NATURAL

WJB010P2100232  
NATURAL WALNUT / NOGAL NATURAL



PACK 2 DRAWER  
CABINET + TECKSTONE  
+ MIRROR + WALL  
LAMP

PACK MUEBLE  
2 CAJONES +  
TECKSTONE + ESPEJO  
+ APLIQUE

60X45,5X61,5 CM  
23,62X17,91X24,21 IN



**NEW** WJB010P0613102  
MATT WHITE / BLANCO MATE

WJB010P0613229  
GLOSSY WHITE / BLANCO BRILLO

**NEW** WJB010P0613194  
NATURAL OAK / ROBLE NATURAL

WJB010P0613232  
NATURAL WALNUT / NOGAL NATURAL





PACK 2 DRAWER  
CABINET + TECKSTONE  
+ MIRROR + WALL  
LAMP

PACK MUEBLE  
2 CAJONES +  
TECKSTONE + ESPEJO  
+ APLIQUE

80X45,5X61,5 CM  
31,5X17,9X24,21 IN



**NEW** WJB010P0814102  
MATT WHITE / BLANCO MATE



WJB010P0814229  
GLOSSY WHITE / BLANCO BRILLO



**NEW** WJB010P0814194  
NATURAL OAK / ROBLE NATURAL



WJB010P0814232  
NATURAL WALNUT / NOGAL NATURAL



PACK 2 DRAWER  
CABINET + TECKSTONE  
+ MIRROR + WALL  
LAMP

PACK MUEBLE  
2 CAJONES +  
TECKSTONE + ESPEJO  
+ APLIQUE

100X45,5X61,5 CM  
39,57X17,9X24,21 IN



**NEW** WJB010P1014102  
MATT WHITE / BLANCO MATE



WJB010P1014229  
GLOSSY WHITE / BLANCO BRILLO



**NEW** WJB010P1014194  
NATURAL OAK / ROBLE NATURAL



WJB010P1014232  
NATURAL WALNUT / NOGAL NATURAL





PACK 3 DRAWER  
CABINET + TECKSTONE  
+ MIRROR + WALL  
LAMP

PACK MUEBLE  
3 CAJONES +  
TECKSTONE + ESPEJO  
+ APLIQUE

80X45,5X61,5 CM  
31,5X17,91X24,21 IN



**NEW** WJB010P8103102  
MATT WHITE / BLANCO MATE



WJB010P8103229  
GLOSSY WHITE / BLANCO BRILLO



**NEW** WJB010P8103194  
NATURAL OAK / ROBLE NATURAL



WJB010P8103232  
NATURAL WALNUT / NOGAL NATURAL



PACK 3 DRAWER  
CABINET + TECKSTONE  
+ MIRROR + WALL  
LAMP

PACK MUEBLE  
3 CAJONES +  
TECKSTONE + ESPEJO  
+ APLIQUE

100X45,5X61,5 CM  
39,37X17,91X24,21 IN



**NEW** WJB010P0101102  
MATT WHITE / BLANCO MATE



WJB010P0101229  
GLOSSY WHITE / BLANCO BRILLO



**NEW** WJB010P0101194  
NATURAL OAK / ROBLE NATURAL



WJB010P0101232  
NATURAL WALNUT / NOGAL NATURAL





PACK 4 DRAWER  
CABINET + TECKSTONE  
+ MIRROR + WALL  
LAMP

PACK MUEBLE  
4 CAJONES +  
TECKSTONE + ESPEJO  
+ APLIQUE

120X45,5X61,5 CM  
47,24X17,91X24,21 IN



**NEW** WJB010P1213102  
MATT WHITE / BLANCO MATE



WJB010P1213229  
GLOSSY WHITE / BLANCO BRILLO



**NEW** WJB010P1213194  
NATURAL OAK / ROBLE NATURAL



WJB010P1213232  
NATURAL WALNUT / NOGAL NATURAL



CABINET  
ARMARIO

26,5X26X15,5 CM  
10,43X10,24X6,1 IN

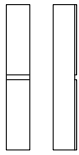

**NEW** WJB010M0005102  
MATT WHITE / BLANCO MATE



WJB010M0005229  
GLOSSY WHITE / BLANCO BRILLO



**NEW** WJB010M0005194  
NATURAL OAK / ROBLE NATURAL



WJB010M0005232  
NATURAL WALNUT / NOGAL NATURAL



SET OF 2 LEGS

JUEGO DE DOS 2 PATAS

31,9X15,3X19,4 CM  
12,56X6,02X7,64 IN



WJB010M0040001  
CHROME / CROMO



◆  
**MIRROR**  
ESPEJO  
60X3X80 CM  
23,62X1,18X31,5 IN



WJB005M0001000 

◆  
**MIRROR**  
ESPEJO  
80X3X80 CM  
31,5X1,18X31,5 IN



WJB005M0002000 

◆  
**MIRROR**  
ESPEJO  
80X3X100 CM  
31,5X1,18X39,37 IN



WJB005M0003000 

◆  
**MIRROR**  
ESPEJO  
80X3X50 CM  
31,5X1,18X19,69 IN



WJB005M0004000

◆  
**MIRROR**  
ESPEJO  
120X3X80 CM  
47,24X1,18X31,5 IN



WJB005M0005000

◆  
**MIRROR**  
ESPEJO  
40X3X40 CM  
15,75X1,18X15,75 IN



WJB005M0006000

◆  
**MIRROR**  
ESPEJO  
60X3X60 CM  
23,62X1,18X23,62 IN



WJB005M0007000

◆  
**MIRROR**  
ESPEJO  
80X3X80 CM  
31,5X1,18X31,5 IN



WJB005M0008000





●  
LED WALL LAMP  
APLIQUE LED  
28X11,2X3 CM  
11,02X4,41X1,18 IN



WJB005A0007001  
CHROME / CROMO

●  
LED WALL LAMP  
APLIQUE LED  
49,4X11,2X3 CM  
19,45X4,41X1,18 IN



WJB005A0008001  
CHROME / CROMO

●  
LED WALL LAMP  
APLIQUE LED  
80X11,2X3 CM  
31,5X4,41X1,18 IN



WJB005A0014001  
CHROME / CROMO

●  
LED WALL LAMP  
APLIQUE LED  
100X11,2X3 CM  
39,37X4,41X1,18 IN



WJB005A0015001  
CHROME / CROMO



# Compact

Design by **Cosmic Studio**





# Compact

Design by Cosmic Studio



**Optimum ultraviolet resistance:** compact, non-porous, hygienic, resistant and pleasant to the touch thanks to the velvety finish, similar to natural stone.

**Óptima resistencia a los rayos ultravioletas:** es compacto, no poroso, higiénico, resistente y agradable al tacto gracias a su acabado aterciopelado, similar al de la piedra natural.

**CRISTALPLANT**

**5**  
YEARS  
GUARANTEE  
AÑOS  
GARANTÍA

**Durable and recoverable:** this material regains its original appearance using soapy water and a scrubber which will eliminate even cigarette burns. The durable and recoverable nature make this is an eco-compatible material.

**Duradero y recuperable:** material que puede recuperar completamente su aspecto original utilizando simplemente detergentes y estropajos abrasivos para eliminar incluso las quemaduras de cigarrillo. Sus propiedades de duración y capacidad de recuperación lo convierten en un material eco-compatible.

**Highly fire resistant:** the material is practically fireproof, with Class 1 fire resistance rating.

**Alta resistencia al fuego:** es prácticamente ignífugo, con certificado de resistencia al fuego Clase 1.



Easy wall fixing. Integrated drawer.

Fácil anclaje a pared. Cajón Integrado.

**Compact** has successfully passed the high demanding tests of long last durability and resistance to extreme uses (static charge or impact testing) to assure long last durability of the product.

Toda la gama **Compact** ha superado con éxito exigentes tests de durabilidad y resistencia a usos extremos (cargas estáticas o test de impacto), para asegurar una larga vida al producto.





**WASHBASIN WITH TRAP WITHOUT TAP HOLE**  
LAVABO CON SIFÓN SIN AGUJERO

32,5X32,5X15 CM  
12,8X12,8X5,91 IN

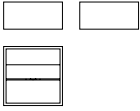

**WJC739L0400500**  
MATTE / MATE



**WASHBASIN WITH TRAP WITHOUT TAP HOLE**  
LAVABO CON SIFÓN SIN AGUJERO

40X40X15 CM  
15,75X15,75X5,91 IN

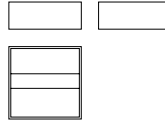

**WJC739L0600500**  
MATTE / MATE



**WASHBASIN/STORAGE WITH TRAP WITHOUT TAP HOLE**  
LAVABO/CAJÓN CON SIFÓN SIN AGUJERO

32,5X32,5X25 CM  
12,8X12,8X9,84 IN

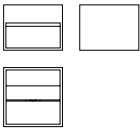

**WJC739L0410500**  
MATTE / MATE



**WASHBASIN/STORAGE WITH TRAP WITHOUT TAP HOLE**  
LAVABO/CAJÓN CON SIFÓN SIN AGUJERO

40X50X50 CM  
15,75X19,69X19,69 IN

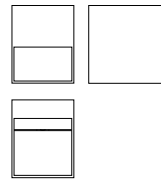

**WJC739L0630500**  
MATTE / MATE



**WASHBASIN/STORAGE WITH TRAP WITHOUT TAP HOLE**  
LAVABO/CAJÓN CON SIFÓN SIN AGUJERO

80X40X20 CM  
31,5X15,75X7,87 IN

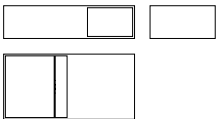

**WJC739L1400500**  
MATTE / MATE



**WASHBASIN/STORAGE WITH TRAP WITHOUT TAP HOLE**  
LAVABO/CAJÓN CON SIFÓN SIN AGUJERO

100X40X20 CM  
39,37X15,75X7,87 IN



**WJC739L1800500**  
MATTE / MATE



**LEFT WASHBASIN/LATERAL STORAGE WITH TRAP WITHOUT TAP HOLE**  
LAVABO IZQUIERDO/CAJÓN LATERAL CON SIFÓN SIN AGUJERO

40X20X40 CM  
15,75X7,87X15,75 IN

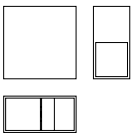

**WJC739L0610500**  
MATTE / MATE



**RIGHT WASHBASIN/LATERAL DRAWER WITHOUT TAP HOLE**  
LAVABO DERECHO/CAJÓN LATERAL CON SIFÓN SIN AGUJERO

40X20X40 CM  
15,75X7,87X15,75 IN

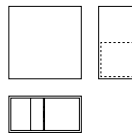

**WJC739L0620500**  
MATTE / MATE



# Compact

Design by **Cosmic Studio**



DOUBLE WASHBASIN WITH TRAP WITHOUT TAP HOLE  
LAVABO DOBLE CON SIFÓN SIN AGUJERO

120X50X15 CM  
47,24X19,69X5,91 IN



**WJC739L2200500**  
MATTE / MATE

WASHBASIN WITH TRAP  
LAVABO CON SIFÓN

32,5X32,5X15 CM  
12,8X12,8X5,91 IN

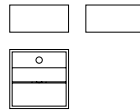

**WJC739L0401500**  
MATTE / MATE

WASHBASIN WITH TRAP  
LAVABO CON SIFÓN

40X40X15 CM  
15,75X15,75X5,91 IN

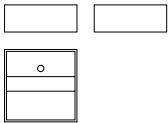

**WJC739L0601500**  
MATTE / MATE

WASHBASIN/STORAGE WITH TRAP  
LAVABO/CAJÓN CON SIFÓN

32,5X32,5X25 CM  
12,8X12,8X9,84 IN

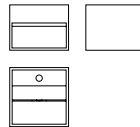

**WJC739L0411500**  
MATTE / MATE



WASHBASIN/STORAGE WITH TRAP  
LAVABO/CAJÓN CON SIFÓN

40X50X50 CM  
15,75X19,69X19,69 IN

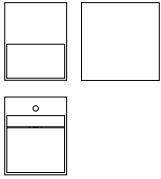

WJC739L0631500  
MATTE / MATE

WASHBASIN/STORAGE WITH TRAP  
LAVABO/CAJÓN CON SIFÓN

80X40X20 CM  
31,5X15,75X7,87 IN

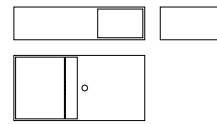

WJC739L1401500  
MATTE / MATE

WASHBASIN/STORAGE WITH TRAP  
LAVABO/CAJÓN CON SIFÓN

100X40X20 CM  
39,37X15,75X7,87 IN

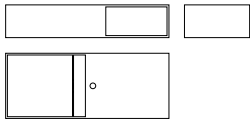

WJC739L1801500  
MATTE / MATE

LEFT WASHBASIN/LATERAL STORAGE WITH TRAP  
LAVABO IZQUIERDO/CAJÓN LATERAL CON SIFÓN

40X20X40 CM  
15,75X7,87X15,75 IN

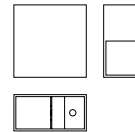

WJC739L0611500  
MATTE / MATE



# Compact

Design by Cosmic Studio



RIGHT WASHBASIN / LATERAL STORAGE WITH TRAP  
LAVABO DERECHO/CAJON LATERAL CON SIFÓN

40X20X40 CM  
15,75X7,87X15,75 IN

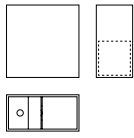

WJC739L0621500  
MATTE / MATE

DOUBLE WASHBASIN WITH TRAP  
LAVABO DOBLE CON SIFÓN

120X50X15 CM  
47,24X19,69X5,91 IN

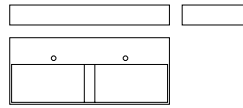

WJC739L2201500  
MATTE / MATE

FREE DRAIN VALVE  
VÁLVULA DESCARGA LIBRE

7,5X7,5X9,1 CM  
2,95X2,95X3,58 IN



WJC341R7600000  
CHROME / CROMO



WJC341R0786000  
MATTE WHITE / BLANCO MATE



WJC341R0787000  
MATTE BLACK / NEGRO MATE





**VALVE**

VALVULA CLICK-CLACK

6,2X6,2X8,4 CM  
2,44X2,44X3,31 IN



**WJC341R0387000**  
CHROME / CROMO



**WJC341R0789000**  
MATTE WHITE / BLANCO MATE



**WJC341R0790000**  
MATTE BLACK / NEGRO MATE



**TRAP**

SIFÓN

8,5X30,2X35 CM  
3,35X11,89X13,78 IN



**WJC341R0590000**  
CHROME / CROMO



**WJC341R0791000**  
MATTE WHITE / BLANCO MATE



**WJC341R0792000**  
MATTE BLACK / NEGRO MATE



# Equilibrium

Design by Edward van Vliet





# Equilibrium

Design by **Edward van Vliet**

AxBxC CM  
INCH AxBxC



Equilibrium is harmony between the sun and the moon, between the natural and the artificial, between the cosmos and the Earth.

---

Equilibrium es la armonía entre el sol y la luna, entre lo natural y lo artificial, entre el cosmos y la Tierra.





🌀  
**WASHBASIN**  
 LAVABO  
 42X42X14,5 CM  
 16,54X16,54X5,71 IN

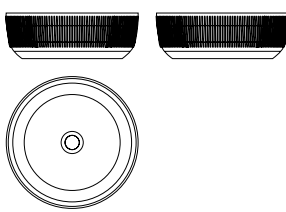

**WJP077L5502520**  
 RIBS MATTE WHITE / RAYAS BLANCO  
 MATE



# Fancy

Design by **Cosmic Studio**





# Fancy

Design by Cosmic Studio



A **solid surface** with a high percentage of natural mineral deposits. It stands out for its glossy feel and its durability. It is a fireproof material, compact and non-porous and both hygienic and resistant. Available in solid matt white.

Un **solid surface** con un alto porcentaje de cargas minerales naturales. Destaca por su tacto satinado y su durabilidad. Es un material ignífugo, compacto y no poroso, higiénico y resistente. Disponible en blanco mate homogéneo.

## PROPERTIES / PROPIEDADES

**Resistant:** Durable surface, easy to maintain and renewable.

**Resistente:** Superficie duradera, con fácil mantenimiento y renovable.

Chromed self-cleaning trap.

Sifón autolimpiante que evita la sedimentación de restos.

Rounded corners to let easy maintenance.

Ángulos redondeados que facilitan la limpieza.



**Homogeneous:** The color and texture of this material are homogeneous throughout its thickness and do not suffer wear.

**Homogéneo:** El color y la textura de este material son homogéneos en todo su espesor y no sufren desgaste.

**Hygienic:** It is a non-porous material, totally solid and can be transformed with completely invisible joints. That is why it is a very hygienic surface.

**Higiénico:** Es un material no poroso, totalmente macizo y se puede transformar con juntas completamente invisibles. Por eso es una superficie muy higiénica.





**Fancy** has successfully passed the high demanding tests of long last durability and resistance to extreme uses (static charge or impact testing) to assure long last durability of the product.

Toda la gama **Fancy** ha superado con éxito exigentes tests de durabilidad y resistencia a usos extremos (cargas estáticas o test de impacto), para asegurar una larga vida al producto.

**High quality laminate finishes.**

High resistance to abrasion, waterproof and easy maintenance. Colours unalterable.

**Acabados laminados de alta gama.**

Gran resistencia a la abrasión, impermeables y de fácil limpieza. Los tonos se mantienen inalterables a lo largo del tiempo.

**Eco friendly:** furniture made in Spain with certified wood board (PEFC/FSC) following the chain of custody in forestry.

**Producto ambientalmente responsable:** muebles fabricados en España con tableros de madera certificada (PEFC/FSC) conforme la cadena de custodia de productos forestales.

**Repairable:** This surface is renewable, which means that many of the damages that can occur can be removed using a damp wet sandpaper. On the other hand, the most serious damages can be repaired without having to replace the entire material.

**Reparable:** Esta superficie es renovable, lo que significa que muchos de los daños que pueden producirse se pueden eliminar utilizando una lija al agua humedecida. Por otra parte, los daños más graves pueden ser reparados sin tener que reemplazar la totalidad del material.

**Non-toxic:** It is an inert and non-toxic material. Under normal temperature conditions, it does not emit gases.

**No tóxico:** Es un material inerte y no tóxico. Bajo condiciones normales de temperatura, no emite gases.

**FINISHES / ACABADOS**

**Blanco mate y blanco brillo:** Ambos acabados se consiguen tras pulir la superficie compacta consiguiendo así un aspecto cualitativo.

**Blanco mate y blanco brillo:** Ambos acabados se consiguen tras pulir la superficie compacta consiguiendo así un aspecto cualitativo.



NEW  
FINISH





**1 LEFT DOOR CABINET WITH LEFT GLOSSY WASHBASIN**

MUEBLE CON LAVABO BRILLO IZDA 1 PUERTA IZDA

40X20X50 CM  
15,75X7,87X19,69 IN

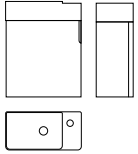

**WJC747M0004129**  
WHITE MATTE TECHNICAL / BLANCO MATE TECNICO



**NEW** **WJC747M0004194**  
OAK / ROBLE



**WJC747M0004130**  
ANTHRACITE MATTE TECHNICAL / ANTRACITA MATE TECNICO



**WJC747M0004132**  
SLATE OAK / ROBLE PIZARRA



**1 LEFT DOOR CABINET WITH LEFT MATTE WASHBASIN**

MUEBLE CON LAVABO MATE IZDA 1 PUERTA IZDA

40X20X50 CM  
15,75X7,87X19,69 IN

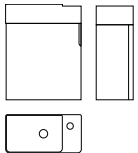

**WJC747M0008129**  
WHITE MATTE TECHNICAL / BLANCO MATE TECNICO



**NEW** **WJC747M0008194**  
OAK / ROBLE



**WJC747M0008130**  
ANTHRACITE MATTE TECHNICAL / ANTRACITA MATE TECNICO



**WJC747M0008132**  
SLATE OAK / ROBLE PIZARRA



**1 RIGHT DOOR CABINET WITH RIGHT GLOSSY WASHBASIN**

MUEBLE CON LAVABO BRILLO DCHO 1 PUERTA DCHA

40X20X50 CM  
15,75X7,87X19,69 IN

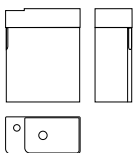

**WJC747M0005129**  
WHITE MATTE TECHNICAL / BLANCO MATE TECNICO



**NEW** **WJC747M0005194**  
OAK / ROBLE



**WJC747M0005130**  
ANTHRACITE MATTE TECHNICAL / ANTRACITA MATE TECNICO



**WJC747M0005132**  
SLATE OAK / ROBLE PIZARRA



**1 RIGHT DOOR CABINET WITH RIGHT MATTE WASHBASIN**

MUEBLE CON LAVABO MATE DCHO 1 PUERTA DCHA

40X20X50 CM  
15,75X7,87X19,69 IN

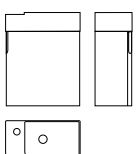

**WJC747M0009129**  
WHITE MATTE TECHNICAL / BLANCO MATE TECNICO



**NEW** **WJC747M0009194**  
OAK / ROBLE



**WJC747M0009130**  
ANTHRACITE MATTE TECHNICAL / ANTRACITA MATE TECNICO



**WJC747M0009132**  
SLATE OAK / ROBLE PIZARRA





## 2 DOORS CABINET WITH LEFT GLOSSY WASHBASIN

MUEBLE CON LAVABO BRILLO IZDO 2 PUERTAS

60X20X60 CM  
23,62X7,87X23,62 IN

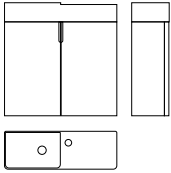

**WJC747M0006129**  
WHITE MATTE TECHNICAL / BLANCO  
MATE TECNICO



**NEW** **WJC747M0006194**  
OAK / ROBLE



**WJC747M0006130**  
ANTHRACITE MATTE TECHNICAL /  
ANTRACITA MATE TECNICO



**WJC747M0006132**  
SLATE OAK / ROBLE PIZARRA



## 2 DOORS CABINET WITH LEFT MATE WASHBASIN

MUEBLE CON LAVABO MATE IZDO 2 PUERTAS

60X20X60 CM  
23,62X7,87X23,62 IN

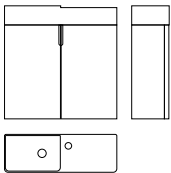

**WJC747M0010129**  
WHITE MATTE TECHNICAL / BLANCO  
MATE TECNICO



**NEW** **WJC747M0010194**  
OAK / ROBLE



**WJC747M0010130**  
ANTHRACITE MATTE TECHNICAL /  
ANTRACITA MATE TECNICO



**WJC747M0010132**  
SLATE OAK / ROBLE PIZARRA



## 2 DOORS CABINET WITH RIGHT GLOSSY WASHBASIN

MUEBLE CON LAVABO BRILLO DCHO 2 PUERTAS

60X20X60 CM  
23,62X7,87X23,62 IN

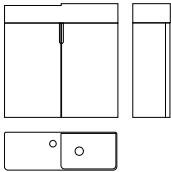

**WJC747M0007129**  
WHITE MATTE TECHNICAL / BLANCO  
MATE TECNICO



**NEW** **WJC747M0007194**  
OAK / ROBLE



**WJC747M0007130**  
ANTHRACITE MATTE TECHNICAL /  
ANTRACITA MATE TECNICO



**WJC747M0007132**  
SLATE OAK / ROBLE PIZARRA



## 2 DOORS CABINET WITH LEFT MATTE WASHBASIN

MUEBLE CON LAVABO MATE DCHO 2 PUERTAS

60X20X60 CM  
23,62X7,87X23,62 IN

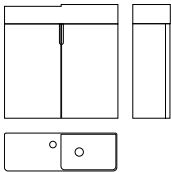

**WJC747M0011129**  
WHITE MATTE TECHNICAL / BLANCO  
MATE TECNICO



**NEW** **WJC747M0011194**  
OAK / ROBLE



**WJC747M0011130**  
ANTHRACITE MATTE TECHNICAL /  
ANTRACITA MATE TECNICO



**WJC747M0011132**  
SLATE OAK / ROBLE PIZARRA





**LEFT WASHBASIN WITHOUT TRAP**  
LAVABO IZQUIERDO SIN SIFÓN

40X20X15 CM  
15,75X7,87X5,91 IN

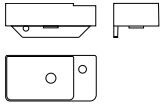

**WJC747L0600530**  
GLOSSY / BRILLO



**LEFT WASHBASIN WITHOUT TRAP**  
LAVABO IZQUIERDO SIN SIFÓN

40X20X15 CM  
15,75X7,87X5,91 IN

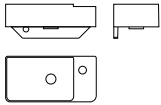

**WJC747L0600500**  
MATTE / MATE



**LEFT WASHBASIN WITHOUT TRAP**  
LAVABO IZQUIERDO SIN SIFÓN

60X20X15 CM  
23,62X7,87X5,91 IN

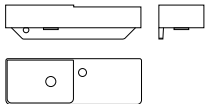

**WJC747L1000530**  
GLOSSY / BRILLO



**WJC747L1000500**  
MATTE / MATE



**RIGHT WASHBASIN WITHOUT TRAP**  
LAVABO DERECHO SIN SIFÓN

40X20X15 CM  
15,75X7,87X5,91 IN

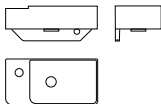

**WJC747L0601530**  
GLOSSY / BRILLO



**WJC747L0601500**  
MATTE / MATE





## RIGHT WASHBASIN WITHOUT TRAP

LAVABO DERECHO SIN SIFÓN

60X20X15 CM  
23,62X7,87X5,91 IN

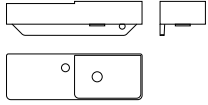

WJC747L1001530  
GLOSSY / BRILLO



WJC747L1001500  
MATTE / MATE



## CORNER WASHBASIN WITHOUT TRAP

LAVABO RINCON SIN SIFÓN

30X30X15 CM  
11,81X11,81X5,91 IN

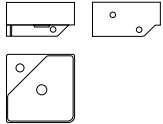

WJC747L0402530  
GLOSSY / BRILLO



WJC747L0402500  
MATTE / MATE



## FREE DRAIN VALVE

VÁLVULA DESCARGA LIBRE

7,5X7,5X9,1 CM  
2,95X2,95X3,58 IN



WJC341R0786000  
MATTE WHITE / BLANCO MATE



WJC341R0787000  
MATTE BLACK / NEGRO MATE



WJC341R7600000  
CHROME / CROMO



## POP-UP VALVE

VÁLVULA CLICK CLACK

6,2X6,2X8,4 CM  
2,44X2,44X3,31 IN



WJC341R0789000  
MATTE WHITE / BLANCO MATE



WJC341R0790000  
MATTE BLACK / NEGRO MATE



WJC341R0387000  
CHROME / CROMO



△  
TRAP  
SIFÓN

8,5X30,2X35 CM  
3,35X11,89X13,78 IN



WJC341R0791000  
MATTE WHITE / BLANCO MATE



WJC341R0792000  
MATTE BLACK / NEGRO MATE



# Mood







Gentle curves for a bathtub that seduces the eye and relaxes the body.

---

Suaves líneas curvas para una bañera que seduce la vista y relaja el cuerpo.

#### Features

Non-porous material, which prevents the accumulation of bacteria and dirt.

Easy to clean and maintain, more hygienic.

---

#### Características

Material no poroso, por lo que evita la acumulación de bacterias y suciedad.

Fácil limpieza y mantenimiento, más higiénica.

Synthetic resin: Material made of a high percentage of natural minerals [alumina trihydrate (ATH) derived from bauxite] and a low percentage of high purity polyester polymers and acrylics Optimum resistance to UV rays.

---

Resina sintética: material compuesto por un porcentaje elevado de minerales naturales (trihidrato de aluminio -ATH- derivado de la bauxita) y un bajo porcentaje de polímeros poliésteres y acrílicos de gran pureza. Óptima resistencia a los rayos ultravioletas.





# Light

Design by **Cosmic Studio**





Light



# Light

Design by **Cosmic Studio**



Remote controlled applies with bi-LED technology, to regulate intensity and warmth.

Aplique con tecnología bi-LED, que incluye mando para regular la intensidad y calidez de la luz.

**3**  
YEARS GUARANTEE  
AÑOS GARANTÍA  
**COSMIC**

Conceived to illuminate bathroom atmospheres with the focus on the environment not the light source. Sober, subtle shapes that become one with the components.

Concebido para iluminar ambientes de baño resaltando el entorno y no la fuente de luz. Formas sobrias sin estridencias que se suman al conjunto de elementos.

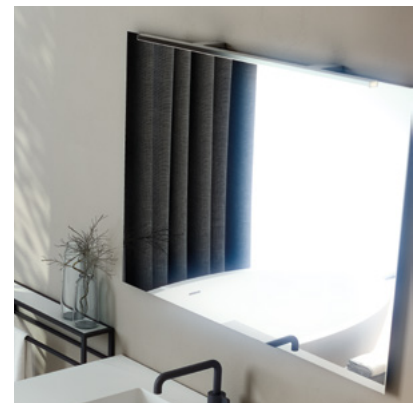

## FINISHES / ACABADOS



**001**  
CHROME  
CROMO



LED WALL LAMP  
APLIQUE LED  
28X11,2X3 CM  
11,02X4,41X1,18 IN



WJB005A0007001  
CHROME / CROMO

LED WALL LAMP  
APLIQUE LED  
49,4X11,2X3 CM  
19,45X4,41X1,18 IN



WJB005A0008001  
CHROME / CROMO

LED WALL LAMP  
APLIQUE LED  
80X11,2X3 CM  
31,5X4,41X1,18 IN



WJB005A0014001  
CHROME / CROMO

LED WALL LAMP  
APLIQUE LED  
100X11,2X3 CM  
39,37X4,41X1,18 IN



WJB005A0015001  
CHROME / CROMO



# Mirrors

Design by **Cosmic Studio**





# Lagoon

Design by **Cosmic Studio**

AxBxC CM  
INCH AxBxC



**5**  
YEARS GUARANTEE  
AÑOS GARANTÍA  
**COSMIC**

Mirrors with ambient LED lighting encapsulated in a neon tube, with an elastic diffuser and invisible LED points to offer more uniform perimeter lighting. Mirror with polished edge and radius of 10 mm following the same rounded design language as the countertops and furniture to achieve a cohesive set.

Espejos con luz led ambiental encapsulada en tubo de neón, con difusor elástico y puntos de led invisibles, ofrece una iluminación perimetral más uniforme. Espejo con canto pulido de radio 10 mm siguiendo el mismo lenguaje de diseño como de las encimeras y mobiliario para conseguir un conjunto cohesionado.



Polished edge and radius of 10 mm

Canto pulido radio 10 mm



Anti-fog system

Sistema antivaho



Samsung LED 3000 °K

Samsung LED 3000 °K



Switch-on sensor

Sensores de encendido



Switch-off timer

Temporizador de apagado



Anti-condensation system is switched off after 2 hours of operation

El antivaho se apaga a las 2 horas de su funcionamiento



Light is switched off after 12 hours of operation

La luz se apaga a las 12 horas de su funcionamiento



Adjustable wall brackets

Soportes pared regulables



◆  
**AMBIENT LED LIGHTING MIRROR**  
ESPEJO LED AMBIENTAL REDONDO

**60X2,9X60 CM**  
23,62X1,14X23,62 IN



WJC781M0064000

◆  
**AMBIENT LED LIGHTING MIRROR**  
ESPEJO LED AMBIENTAL REDONDO

**80X2,9X80 CM**  
31,5X1,14X31,5 IN



WJC781M0065000

◆  
**AMBIENT LED LIGHTING MIRROR**  
ESPEJO LED AMBIENTAL REDONDO

**100X2,9X100 CM**  
39,37X1,14X39,37 IN



WJC781M0066000

◆  
**AMBIENT LED LIGHTING MIRROR**  
ESPEJO LED AMBIENTAL  
CUADRADO

**60X2,9X80 CM**  
23,62X1,14X31,5 IN



WJC781M0060000

◆  
**AMBIENT LED LIGHTING MIRROR**  
ESPEJO LED AMBIENTAL  
CUADRADO

**80X2,9X80 CM**  
31,5X1,14X31,5 IN



WJC781M0061000

◆  
**AMBIENT LED LIGHTING MIRROR**  
ESPEJO LED AMBIENTAL  
CUADRADO

**100X2,9X80 CM**  
39,37X1,14X31,5 IN



WJC781M0062000

◆  
**AMBIENT LED LIGHTING MIRROR**  
ESPEJO LED AMBIENTAL  
CUADRADO

**120X2,9X80 CM**  
47,24X1,14X31,5 IN



WJC781M0063000

◆  
**AMBIENT LED LIGHTING MIRROR**  
ESPEJO LED AMBIENTAL OVALADO

**50X2,9X100 CM**  
19,69X1,14X39,37 IN



WJC781M0067000





**Features**

LED Samsung  
Measurements: 60 cm / 80 cm / 100 cm  
Power: 12 W / 12 W / 30 W  
Lumens: 710 LM / 810 LM / 890 LM  
Duration: 36 000h  
Temperature: 4000 k  
Finishes: chrome / black

**Características**

LED Samsung  
Medidas: 60 cm / 80 cm / 100 cm  
Potencia: 12 W / 12 W / 30 W  
Lúmenes: 710 LM / 810 LM / 890 LM  
Duración: 36 000h  
Temperatura: 4000 k  
Acabados: negro mate / oro mate

**FINISHES / ACABADOS**



108

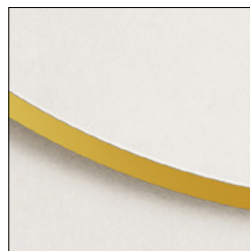

740



◆  
**MIRROR**  
ESPEJO  
100X2,3X100 CM  
39,37X0,91X39,37 IN

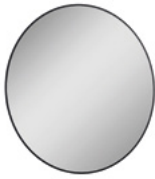

**WJC780M0003108**  
MATTE BLACK / NEGRO MATE



**WJC780M0003740**  
GOLD MATT / ORO MATE

◆  
**MIRROR**  
ESPEJO  
60X2,3X60 CM  
23,62X0,91X23,62 IN



**WJC780M0001108**  
MATTE BLACK / NEGRO MATE



**WJC780M0001740**  
GOLD MATT / ORO MATE

◆  
**MIRROR**  
ESPEJO  
80X2,3X80 CM  
31,5X0,91X31,5 IN

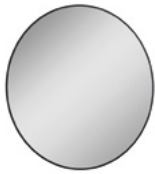

**WJC780M0002108**  
MATTE BLACK / NEGRO MATE



**WJC780M0002740**  
GOLD MATT / ORO MATE

◆  
**LED LIGHTING MIRROR**  
ESPEJO CON LUZ LED  
100X2,5X100 CM  
39,37X0,98X39,37 IN



**WJC780M0006108**  
MATTE BLACK / NEGRO MATE



**WJC780M0006740**  
GOLD MATT / ORO MATE

◆  
**LED LIGHTING MIRROR**  
ESPEJO CON LUZ LED  
60X2,5X60 CM  
23,62X0,98X23,62 IN



**WJC780M0004108**  
MATTE BLACK / NEGRO MATE



**WJC780M0004740**  
GOLD MATT / ORO MATE

◆  
**LED LIGHTING MIRROR**  
ESPEJO CON LUZ LED  
80X2,5X80 CM  
31,5X0,98X31,5 IN



**WJC780M0005108**  
MATTE BLACK / NEGRO MATE



**WJC780M0005740**  
GOLD MATT / ORO MATE





#### Features

Lifetime durability / 10 year guarantee.  
Optional anti-fog system. 480 h test in saline fog (anti-corrosion).

#### Características

Lifetime durability / garantía 10 años.  
Sistema antivaho free fog system opcional. Test de 480 h en niebla salina (anticorrosión).

#### FINISHES / ACABADOS



**81**  
BISONET  
BISONET



◆  
**MIRROR**  
ESPEJO  
80X3X50 CM  
31,5X1,18X19,69 IN



WJB005M0004000

◆  
**MIRROR**  
ESPEJO  
60X3X80 CM  
23,62X1,18X31,5 IN



WJB005M0001000 **S**

◆  
**MIRROR**  
ESPEJO  
80X3X80 CM  
31,5X1,18X31,5 IN



WJB005M0002000 **S**

◆  
**MIRROR**  
ESPEJO  
80X3X100 CM  
31,5X1,18X39,37 IN



WJB005M0003000 **S**

◆  
**MIRROR**  
ESPEJO  
120X3X80 CM  
47,24X1,18X31,5 IN



WJB005M0005000

◆  
**MIRROR**  
ESPEJO  
40X3X40 CM  
15,75X1,18X15,75 IN



WJB005M0006000

◆  
**MIRROR**  
ESPEJO  
60X3X60 CM  
23,62X1,18X23,62 IN



WJB005M0007000

◆  
**MIRROR**  
ESPEJO  
80X3X80 CM  
31,5X1,18X31,5 IN



WJB005M0008000



◆  
**MIRROR**  
ESPEJO  
100X3X100 CM  
39,37X1,18X39,37 IN



WJB005M0009000

◆  
**MIRROR**  
ESPEJO  
40X3X60 CM  
15,75X1,18X23,62 IN



WJC281A8133000

◆  
**MIRROR**  
ESPEJO  
40X3X80 CM  
15,75X1,18X31,5 IN



WJC281A8144000

◆  
**MIRROR**  
ESPEJO  
40X3X100 CM  
15,75X1,18X39,37 IN



WJC281A8145000

◆  
**MIRROR**  
ESPEJO  
60X3X60 CM  
23,62X1,18X23,62 IN



WJC281A8146000

◆  
**MIRROR**  
ESPEJO  
60X3X100 CM  
23,62X1,18X39,37 IN



WJC281A8147000

◆  
**MIRROR**  
ESPEJO  
80X3X70 CM  
31,5X1,18X27,56 IN



WJM281A1013000

◆  
**MIRROR**  
ESPEJO  
80X3X90 CM  
31,5X1,18X35,43 IN



WJM281A1015000





◆  
MIRROR  
ESPEJO  
100X3100 CM  
39,37X1,18X39,37 IN



WJC281A8150000



# Mobius

Design by **Cosmic Studio**

Furniture without limits  
Inspiration without limits

Muebles sin límites  
Inspiración sin límites



**COSMIC**

[www.mobiusbycosmic.com](http://www.mobiusbycosmic.com)



# Create your own bathroom at mobiusbycosmic.com

## Crea tu propio baño en mobiusbycosmic.com

A configuration tool to design your bathroom

With Mobius there are no standard models, but a configuration tool to create the furniture that best suits your project. No limits.

Go to [www.mobiusbycosmic.com](http://www.mobiusbycosmic.com) and start imagining.

Un configurador para crear tu baño

En Mobius no hay modelos estándar, sino un configurador para que crees el mueble que mejor se adapta a tu proyecto. Sin límites.

Entra en [www.mobiusbycosmic.com](http://www.mobiusbycosmic.com) y empieza a imaginar.



**1** Choose your model, furniture or washbasin.

Elige modelo, mueble o lavabo.

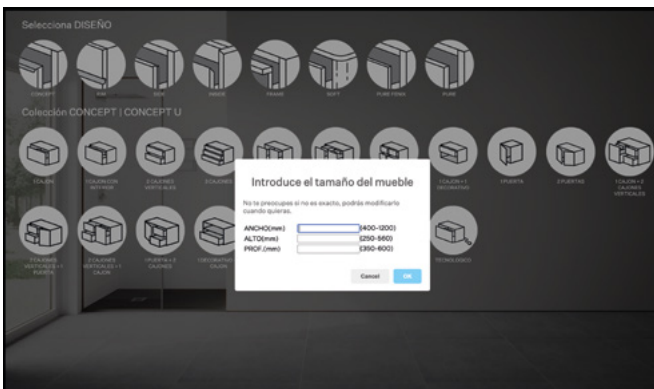

**2** Define the measurements that best suit your space, without unit size limitations.

Define las medidas que se ajustan a tu espacio, sin límites ni módulos.

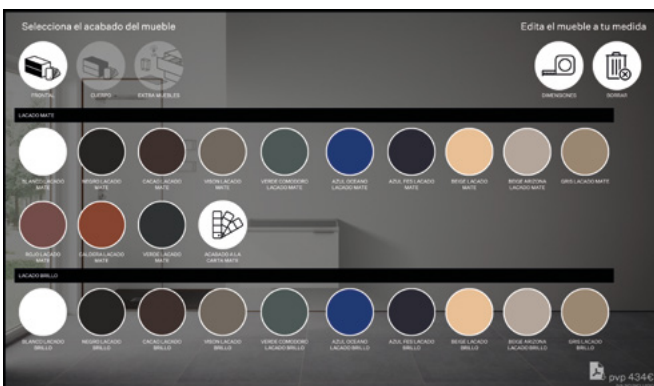

**3** Select your finishes, materials and colours.

Selecciona acabados, materiales y colores.



# Furniture

## Muebles

**Concept U**

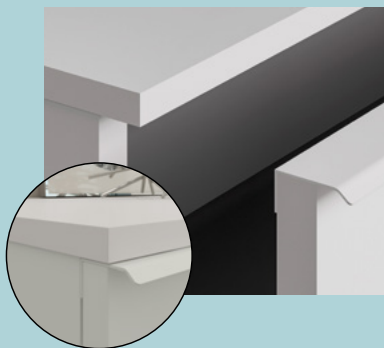

**Concept L**

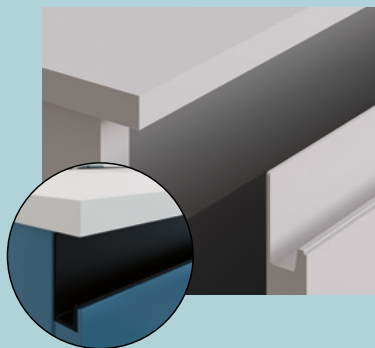

**Concept V**

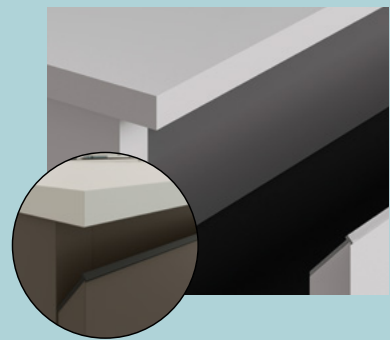

**Pure**

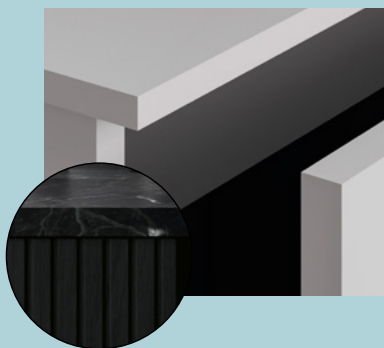

**Soft**

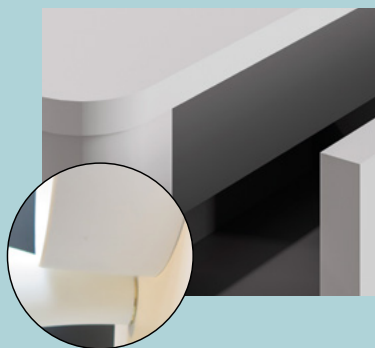

**Side**

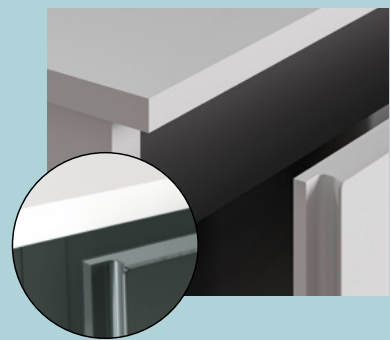

**Rim**

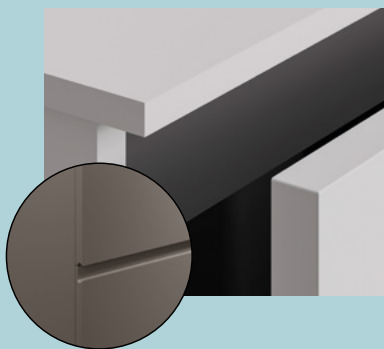

**Frame**

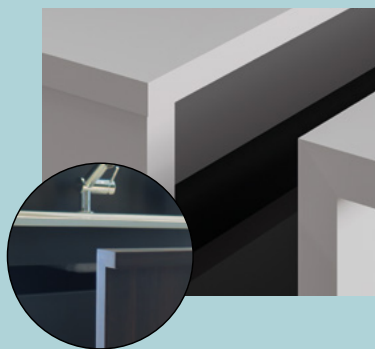

**Inside**

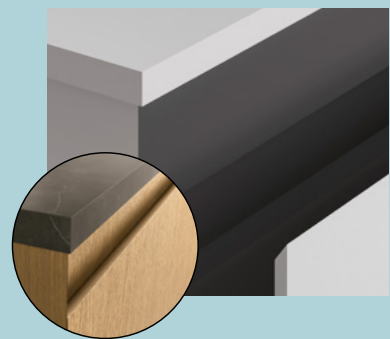

# Mobius Concept U

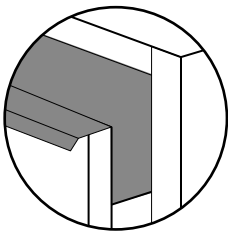

## HANDLE FINISHES ACABADOS DEL TIRADOR



WHITE  
BLANCO



MATTE SILVER  
PLATA MATE



BLACK  
NEGRO

## HANDLE DIMENSIONS ACABADOS DEL TIRADOR

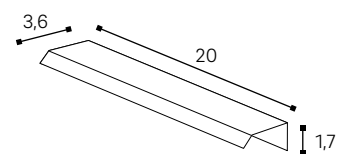

INCH 1.42x7.87x0.67



# Mobius Concept U



1 DRAWER. DEPTH: 46.5CM  
1 CAJÓN. PROFUNDIDAD 46,5CM

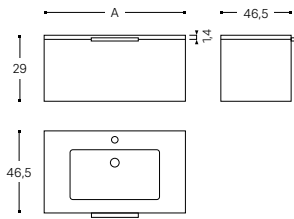

INCH 31,5 x 11,4 x 18,3



A	■ ▲ ○	■ ▲ ○	■ ▲ ○
63 CM	<b>C220013453</b>	<b>C220013491</b>	<b>C220013503</b>
70 CM	<b>C220013454</b>	<b>C220013492</b>	<b>C220013504</b>
80 CM	<b>C220013458</b>	<b>C220013493</b>	<b>C220013506</b>
90 CM	<b>C220013459</b>	<b>C220013494</b>	<b>C220013507</b>
100 CM	<b>C220013461</b>	<b>C220013495</b>	<b>C220013509</b>
110 CM	<b>C220013462</b>	<b>C220013496</b>	<b>C220013510</b>
120 CM	<b>C220013464</b>	<b>C220013497</b>	<b>C220013512</b>



2 DRAWERS. DEPTH: 46.5CM  
2 CAJONES. PROFUNDIDAD 46,5CM

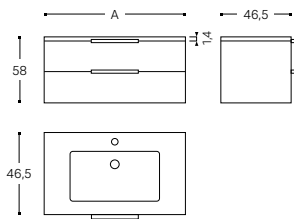

INCH 31,5 x 22,8 x 20,47



A	■ ▲ ○	■ ▲ ○	■ ▲ ○
63 CM	<b>C220013528</b>	<b>C220013569</b>	<b>C220013578</b>
70 CM	<b>C220013530</b>	<b>C220013570</b>	<b>C220013579</b>
80 CM	<b>C220013531</b>	<b>C220013571</b>	<b>C220013580</b>
90 CM	<b>C220013533</b>	<b>C220013572</b>	<b>C220013581</b>
100 CM	<b>C220013534</b>	<b>C220013573</b>	<b>C220013583</b>
110 CM	<b>C220013535</b>	<b>C220013574</b>	<b>C220013584</b>
120 CM	<b>C220013536</b>	<b>C220013576</b>	<b>C220013586</b>

■ MATTE LACQUERED WHITE  
LACADO BLANCO MATE  
058-058

■ NATURAL OAK VENEER  
CHAPA NATURAL ROBLE  
200-200



■ NATURAL WALNUT VENEER  
CHAPA NATURAL NOGAL  
800-800

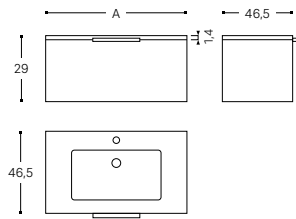

1 DRAWER. DEPTH: 46.5CM  
1 CAJÓN. PROFUNDIDAD 46,5CM



INCH 31,5 x 11,4 x 18,3

A		
63 CM	<b>C220013776</b>	<b>C220013783</b>
70 CM	<b>C220013777</b>	<b>C220013784</b>
80 CM	<b>C220013778</b>	<b>C220013785</b>
90 CM	<b>C220013779</b>	<b>C220013786</b>
100 CM	<b>C220013780</b>	<b>C220013787</b>
110 CM	<b>C220013781</b>	<b>C220013788</b>
120 CM	<b>C220013782</b>	<b>C220013789</b>



2 DRAWERS. DEPTH: 46.5CM  
2 CAJONES. PROFUNDIDAD 46,5CM

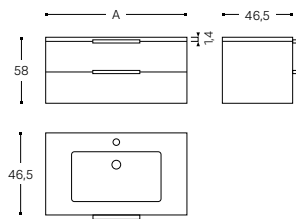

INCH 31,5 x 22,8 x 20,47

A		
63 CM	<b>C220013797</b>	<b>C220013804</b>
70 CM	<b>C220013798</b>	<b>C220013805</b>
80 CM	<b>C220013799</b>	<b>C220013806</b>
90 CM	<b>C220013800</b>	<b>C220013807</b>
100 CM	<b>C220013801</b>	<b>C220013808</b>
110 CM	<b>C220013802</b>	<b>C220013809</b>
120 CM	<b>C220013803</b>	<b>C220013810</b>

 MATTE LACQUERED WHITE  
LACADO BLANCO MATE  
058-058

 SOLID WOOD NATURAL OAK-WOOD VENEER NATURAL OAK  
MADERA MACIZA ROBLE-MADERA CHAPADA ROBLE  
600-200



# Mobius Concept L

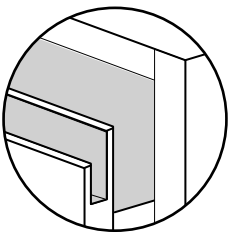

## HANDLE FINISHES ACABADOS DEL TIRADOR

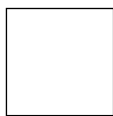

WHITE  
BLANCO



MATTE SILVER  
PLATA MATE



BLACK  
NEGRO

## HANDLE DIMENSIONS ACABADOS DEL TIRADOR

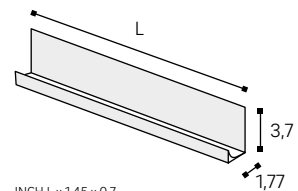

INCH L x 1.45 x 0.7





1 DRAWER. DEPTH: 46.5CM  
1 CAJÓN. PROFUNDIDAD 46,5CM

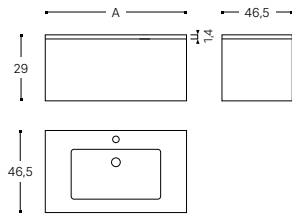

INCH 31,5 x 11,4 x 18,3



A			
63 CM	<b>C220012813</b>	<b>C220012891</b>	<b>C220012898</b>
70 CM	<b>C220012814</b>	<b>C220012892</b>	<b>C220012899</b>
80 CM	<b>C220012816</b>	<b>C220012893</b>	<b>C220012900</b>
90 CM	<b>C220012817</b>	<b>C220012894</b>	<b>C220012901</b>
100 CM	<b>C220012818</b>	<b>C220012895</b>	<b>C220012902</b>
110 CM	<b>C220012820</b>	<b>C220012896</b>	<b>C220012903</b>
120 CM	<b>C220012822</b>	<b>C220012897</b>	<b>C220012904</b>



2 DRAWERS. DEPTH: 46.5CM  
2 CAJONES. PROFUNDIDAD 46,5CM

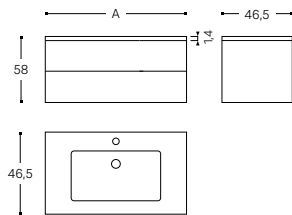

INCH 31,5 x 22,8 x 20,47



A			
63 CM	<b>C220012825</b>	<b>C220012919</b>	<b>C220012929</b>
70 CM	<b>C220012826</b>	<b>C220012920</b>	<b>C220012930</b>
80 CM	<b>C220012828</b>	<b>C220012921</b>	<b>C220012931</b>
90 CM	<b>C220012830</b>	<b>C220012922</b>	<b>C220012932</b>
100 CM	<b>C220012832</b>	<b>C220012923</b>	<b>C220012933</b>
110 CM	<b>C220012833</b>	<b>C220012924</b>	<b>C220012934</b>
120 CM	<b>C220012835</b>	<b>C220012925</b>	<b>C220012935</b>

MATTE LACQUERED WHITE  
LACADO BLANCO MATE  
058-058

NATURAL OAK VENEER  
CHAPA NATURAL ROBLE  
200-200

NATURAL WALNUT VENEER  
CHAPA NATURAL NOGAL  
800-800



# Mobius Concept V

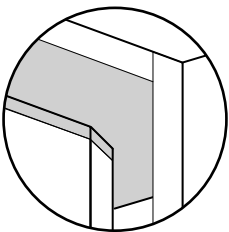

## HANDLE FINISHES ACABADOS DEL TIRADOR

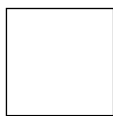

WHITE  
BLANCO



MATTE SILVER  
PLATA MATE



BLACK  
NEGRO

## HANDLE DIMENSIONS ACABADOS DEL TIRADOR

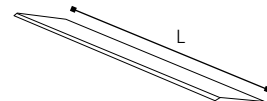



1 DRAWER. DEPTH: 46.5CM  
1 CAJÓN. PROFUNDIDAD 46,5CM

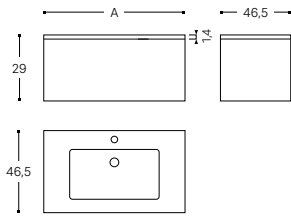

INCH 31,5 x 11,4 x 18,3



A

63 CM

**C220012995**

**C220013201**

**C220013227**

70 CM

**C220012996**

**C220013202**

**C220013228**

80 CM

**C220012997**

**C220013203**

**C220013229**

90 CM

**C220012998**

**C220013204**

**C220013230**

100 CM

**C220012999**

**C220013205**

**C220013231**

110 CM

**C220013000**

**C220013206**

**C220013232**

120 CM

**C220013001**

**C220013207**

**C220013233**



2 DRAWERS. DEPTH: 46.5CM  
2 CAJONES. PROFUNDIDAD 46,5CM

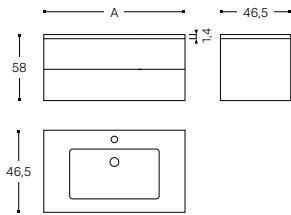

INCH 31,5 x 22,8 x 20,47



A

63 CM

**C220013003**

**C220013208**

**C220013234**

70 CM

**C220013004**

**C220013209**

**C220013235**

80 CM

**C220013005**

**C220013210**

**C220013236**

90 CM

**C220013006**

**C220013211**

**C220013237**

100 CM

**C220013007**

**C220013212**

**C220013238**

110 CM

**C220013008**

**C220013213**

**C220013239**

120 CM

**C220013009**

**C220013214**

**C220013240**

 **MATTE LACQUERED WHITE**  
LACADO BLANCO MATE  
058-058

 **NATURAL OAK VENEER**  
CHAPA NATURAL ROBLE  
200-200

 **NATURAL WALNUT VENEER**  
CHAPA NATURAL NOGAL  
800-800

# Mobius Soft

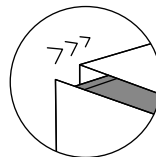
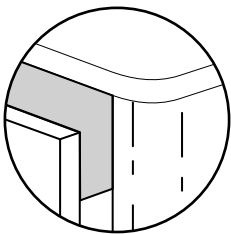

SOFT CLOSE  
SOFT CLOSE

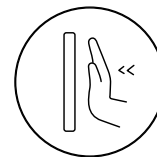

PUSH  
PUSH

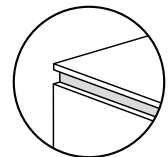

VISIBLE STRUCTURE  
ESTRUCTURA VISTA





1 DRAWER. DEPTH: 50CM  
1 CAJÓN. PROFUNDIDAD 50CM

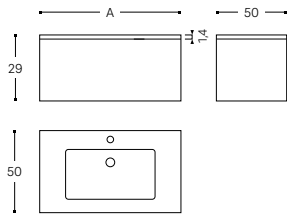

INCH 31,5 x 11,4 x 19,7

A					
63+10 CM	<b>C220014040</b>	<b>C220014026</b>	<b>C220014000</b>	<b>C220014024</b>	<b>C220014025</b>
70+10 CM	<b>C220014042</b>	<b>C220014027</b>	<b>C220014005</b>	<b>C220014032</b>	<b>C220014029</b>
80+10 CM	<b>C220014043</b>	<b>C220014028</b>	<b>C220014007</b>	<b>C220014035</b>	<b>C220014036</b>
90+10 CM	<b>C220014045</b>	<b>C220014030</b>	<b>C220014008</b>	<b>C220014038</b>	<b>C220014037</b>
100+10 CM	<b>C220014047</b>	<b>C220014031</b>	<b>C220014009</b>	<b>C220014039</b>	<b>C220014041</b>
110+10 CM	<b>C220014054</b>	<b>C220014033</b>	<b>C220014010</b>	<b>C220014046</b>	<b>C220014044</b>
120+10 CM	<b>C220014056</b>	<b>C220014034</b>	<b>C220014011</b>	<b>C220014048</b>	<b>C220014049</b>



2 DRAWERS. DEPTH: 50CM  
2 CAJONES. PROFUNDIDAD 50CM

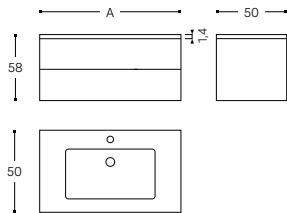

INCH 31,5 x 22,8 x 20,47

A					
63+10 CM	<b>C220014079</b>	<b>C220014062</b>	<b>C220014002</b>	<b>C220014050</b>	<b>C220014051</b>
70+10 CM	<b>C220014081</b>	<b>C220014064</b>	<b>C220014014</b>	<b>C220014053</b>	<b>C220014052</b>
80+10 CM	<b>C220014083</b>	<b>C220014065</b>	<b>C220014015</b>	<b>C220014055</b>	<b>C220014057</b>
90+10 CM	<b>C220014085</b>	<b>C220014067</b>	<b>C220014016</b>	<b>C220014059</b>	<b>C220014058</b>
100+10 CM	<b>C220014086</b>	<b>C220014069</b>	<b>C220014017</b>	<b>C220014060</b>	<b>C220014061</b>
110+10 CM	<b>C220014087</b>	<b>C220014071</b>	<b>C220014018</b>	<b>C220014066</b>	<b>C220014063</b>
120+10 CM	<b>C220014088</b>	<b>C220014072</b>	<b>C220014019</b>	<b>C220014068</b>	<b>C220014070</b>

MATTE LACQUERED BEAVER  
LACADO CASTOR MATE  
009-009

MATTE LACQUERED COMMODORE GREEN  
LACADO VERDE COMODORO MATE  
004-004

MATTE LACQUERED WHITE  
LACADO BLANCO MATE  
058-058

NATURAL OAK VENEER  
CHAPA NATURAL ROBLE  
200-200

NATURAL WALNUT VENEER  
CHAPA NATURAL NOGAL  
800-800

# Mobius Side

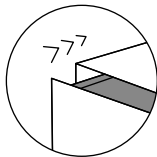
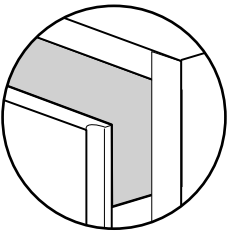

SOFT CLOSE  
SOFT CLOSE



PULL  
ARRASTRE

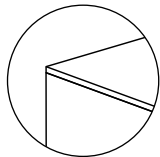

CONCEALED STRUCTURE  
ESTRUCTURA OCULTA





1 DRAWER. DEPTH: 46.5CM  
1 CAJÓN. PROFUNDIDAD 46,5CM

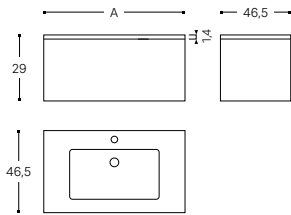

INCH 31,5 x 11,4 x 18,3

A					
63 CM	<b>C220012790</b>	<b>C220012791</b>	<b>C220012775</b>	<b>C220012793</b>	<b>C220012792</b>
70 CM	<b>C220012794</b>	<b>C220012795</b>	<b>C220012811</b>	<b>C220012797</b>	<b>C220012796</b>
80 CM	<b>C220012798</b>	<b>C220012799</b>	<b>C220012815</b>	<b>C220012802</b>	<b>C220012801</b>
90 CM	<b>C220012803</b>	<b>C220012804</b>	<b>C220012819</b>	<b>C220012806</b>	<b>C220012805</b>
100 CM	<b>C220012807</b>	<b>C220012808</b>	<b>C220012821</b>	<b>C220012810</b>	<b>C220012809</b>



2 DRAWERS. DEPTH: 46.5CM  
2 CAJONES. PROFUNDIDAD 46,5CM

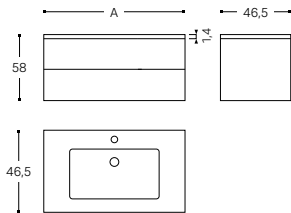

INCH 31,5 x 22,8 x 20,47

A					
63 CM	<b>C220012823</b>	<b>C220012824</b>	<b>C220012781</b>	<b>C220012831</b>	<b>C220012827</b>
70 CM	<b>C220012836</b>	<b>C220012837</b>	<b>C220012834</b>	<b>C220012839</b>	<b>C220012838</b>
80 CM	<b>C220012842</b>	<b>C220012845</b>	<b>C220012840</b>	<b>C220012848</b>	<b>C220012847</b>
90 CM	<b>C220012852</b>	<b>C220012854</b>	<b>C220012849</b>	<b>C220012857</b>	<b>C220012855</b>
100 CM	<b>C220012860</b>	<b>C220012863</b>	<b>C220012859</b>	<b>C220012869</b>	<b>C220012868</b>

MATTE LACQUERED BEAVER  
LACADO CASTOR MATE  
009-009

MATTE LACQUERED COMMODORE GREEN  
LACADO VERDE COMODORO MATE  
004-004

MATTE LACQUERED WHITE  
LACADO BLANCO MATE  
058-058

MATTE LACQUERED BEIGE  
LACADO BEIGE MATE  
007-007

MATTE LACQUERED  
LACADO CALDERA MATE  
011-011

# Mobius Rim

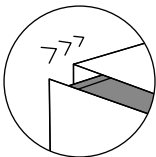
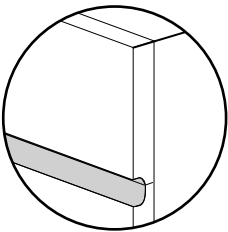

SOFT CLOSE  
SOFT CLOSE



PULL  
ARRASTRE

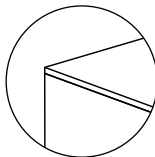

CONCEALED STRUCTURE  
ESTRUCTURA OCULTA





1 DRAWER. DEPTH: 46.5CM  
1 CAJÓN. PROFUNDIDAD 46,5CM

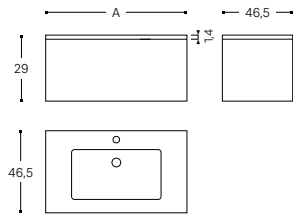

INCH 31,5 x 11,4 x 18,3

A					
63 CM	<b>C220013138</b>	<b>C220013139</b>	<b>C220013136</b>	<b>C220013141</b>	<b>C220013140</b>
70 CM	<b>C220013145</b>	<b>C220013146</b>	<b>C220013143</b>	<b>C220013142</b>	<b>C220013147</b>
80 CM	<b>C220013150</b>	<b>C220013151</b>	<b>C220013149</b>	<b>C220013152</b>	<b>C220013148</b>
90 CM	<b>C220013155</b>	<b>C220013156</b>	<b>C220013154</b>	<b>C220013153</b>	<b>C220013157</b>
100 CM	<b>C220013161</b>	<b>C220013162</b>	<b>C220013160</b>	<b>C220013163</b>	<b>C220013158</b>
110 CM	<b>C220013166</b>	<b>C220013167</b>	<b>C220013165</b>	<b>C220013164</b>	<b>C220013168</b>
120 CM	<b>C220013171</b>	<b>C220013172</b>	<b>C220013170</b>	<b>C220013173</b>	<b>C220013169</b>

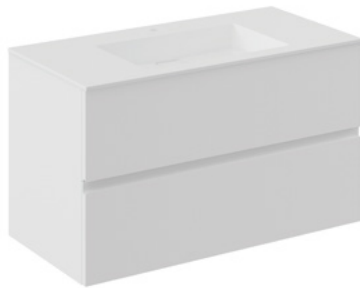

2 DRAWERS. DEPTH: 46.5CM  
2 CAJONES. PROFUNDIDAD 46,5CM

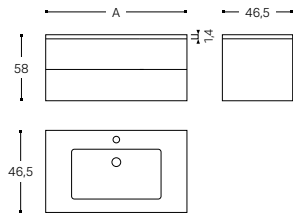

INCH 31,5 x 22,8 x 20,47

A					
63 CM	<b>C220013178</b>	<b>C220013180</b>	<b>C220013177</b>	<b>C220013182</b>	<b>C220013181</b>
70 CM	<b>C220013185</b>	<b>C220013186</b>	<b>C220013184</b>	<b>C220013183</b>	<b>C220013187</b>
80 CM	<b>C220013190</b>	<b>C220013191</b>	<b>C220013189</b>	<b>C220013192</b>	<b>C220013188</b>
90 CM	<b>C220013681</b>	<b>C220013689</b>	<b>C220013674</b>	<b>C220013701</b>	<b>C220013693</b>
100 CM	<b>C220013683</b>	<b>C220013690</b>	<b>C220013675</b>	<b>C220013702</b>	<b>C220013694</b>
110 CM	<b>C220013685</b>	<b>C220013691</b>	<b>C220013676</b>	<b>C220013703</b>	<b>C220013695</b>
120 CM	<b>C220013687</b>	<b>C220013692</b>	<b>C220013678</b>	<b>C220013705</b>	<b>C220013697</b>

MATTE LACQUERED BEAVER  
LACADO CASTOR MATE  
009-009

MATTE LACQUERED COMMODORE GREEN  
LACADO VERDE COMODORO MATE  
004-004

MATTE LACQUERED WHITE  
LACADO BLANCO MATE  
058-058

MATTE LACQUERED BEIGE  
LACADO BEIGE MATE  
007-007

MATTE LACQUERED  
LACADO CALDERA MATE  
011-011

# Mobius Frame

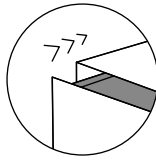
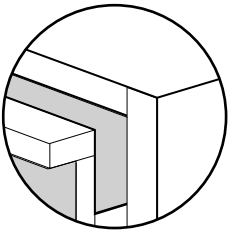

SOFT CLOSE  
SOFT CLOSE

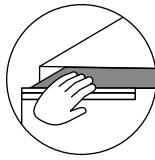

PULL  
ARRASTRE

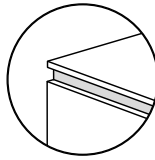

VISIBLE STRUCTURE  
ESTRUCTURA VISTA





1 DRAWER. DEPTH: 47,5CM  
1 CAJÓN. PROFUNDIDAD 47,5CM

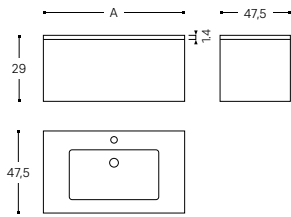

INCH 31,5 x 11,4 x 18,3



A			
63 CM	<b>C220013835</b>	<b>C220013862</b>	<b>C220013870</b>
70 CM	<b>C220013836</b>	<b>C220013864</b>	<b>C220013871</b>
80 CM	<b>C220013840</b>	<b>C220013865</b>	<b>C220013872</b>
90 CM	<b>C220013841</b>	<b>C220013866</b>	<b>C220013874</b>
100 CM	<b>C220013842</b>	<b>C220013867</b>	<b>C220013875</b>
110 CM	<b>C220013843</b>	<b>C220013868</b>	<b>C220013876</b>
120 CM	<b>C220013844</b>	<b>C220013869</b>	<b>C220013877</b>



2 DRAWERS. DEPTH: 47,5CM  
2 CAJONES. PROFUNDIDAD 47,5CM

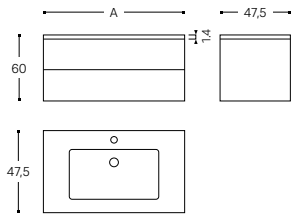

INCH 31,5 x 22,8 x 20,47



A			
63 CM	<b>C220013837</b>	<b>C220013889</b>	<b>C220013932</b>
70 CM	<b>C220013879</b>	<b>C220013892</b>	<b>C220013933</b>
80 CM	<b>C220013880</b>	<b>C220013893</b>	<b>C220013938</b>
90 CM	<b>C220013881</b>	<b>C220013895</b>	<b>C220013939</b>
100 CM	<b>C220013882</b>	<b>C220013896</b>	<b>C220013944</b>
110 CM	<b>C220013884</b>	<b>C220013897</b>	<b>C220013945</b>
120 CM	<b>C220013885</b>	<b>C220013900</b>	<b>C220013950</b>

MATTE LACQUERED WHITE  
LACADO BLANCO MATE  
058-058

NATURAL OAK VENEER  
CHAPA NATURAL ROBLE  
200-200

NATURAL WALNUT VENEER  
CHAPA NATURAL NOGAL  
800-800



# Mobius Inside

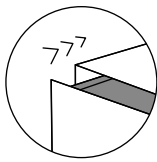
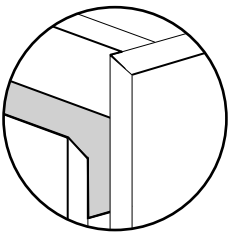

SOFT CLOSE  
SOFT CLOSE

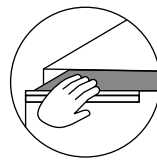

PULL  
ARRASTRE

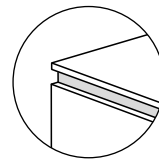

VISIBLE STRUCTURE  
ESTRUCTURA VISTA

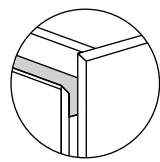

ANGLED STRUCTURE  
ESTRUCTURA INGLETADA





1 DRAWER. DEPTH: 47,5CM  
1 CAJÓN. PROFUNDIDAD 47,5CM

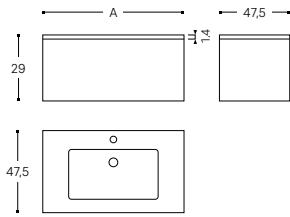

INCH 31,5 x 11,4 x 18,3





A					
63 CM	<b>C220013537</b>	<b>C220013498</b>	<b>C220013439</b>	<b>C220013593</b>	<b>C220013622</b>
70 CM	<b>C220013539</b>	<b>C220013499</b>	<b>C220013440</b>	<b>C220013594</b>	<b>C220013624</b>
80 CM	<b>C220013541</b>	<b>C220013500</b>	<b>C220013445</b>	<b>C220013595</b>	<b>C220013626</b>
90 CM	<b>C220013544</b>	<b>C220013501</b>	<b>C220013446</b>	<b>C220013596</b>	<b>C220013628</b>
100 CM	<b>C220013547</b>	<b>C220013502</b>	<b>C220013447</b>	<b>C220013597</b>	<b>C220013630</b>
110 CM	<b>C220013549</b>	<b>C220013505</b>	<b>C220013448</b>	<b>C220013598</b>	<b>C220013631</b>
120 CM	<b>C220013553</b>	<b>C220013508</b>	<b>C220013449</b>	<b>C220013599</b>	<b>C220013632</b>

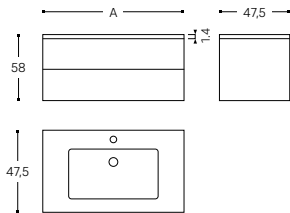

2 DRAWERS. DEPTH: 47,5CM  
2 CAJONES. PROFUNDIDAD 47,5CM



INCH 31,5 x 22,8 x 20,47

A					
63 CM	<b>C220013554</b>	<b>C220013511</b>	<b>C220013441</b>	<b>C220013601</b>	<b>C220013633</b>
70 CM	<b>C220013555</b>	<b>C220013513</b>	<b>C220013452</b>	<b>C220013602</b>	<b>C220013635</b>
80 CM	<b>C220013556</b>	<b>C220013514</b>	<b>C220013455</b>	<b>C220013603</b>	<b>C220013637</b>
90 CM	<b>C220013559</b>	<b>C220013515</b>	<b>C220013456</b>	<b>C220013604</b>	<b>C220013639</b>
100 CM	<b>C220013562</b>	<b>C220013516</b>	<b>C220013457</b>	<b>C220013605</b>	<b>C220013641</b>
110 CM	<b>C220013564</b>	<b>C220013517</b>	<b>C220013460</b>	<b>C220013606</b>	<b>C220013643</b>
120 CM	<b>C220013567</b>	<b>C220013518</b>	<b>C220013463</b>	<b>C220013607</b>	<b>C220013645</b>

 MATTE LACQUERED BEAVER  
LACADO CASTOR MATE  
009-009

 MATTE LACQUERED COMMODORE GREEN  
LACADO VERDE COMODORO MATE  
004-004

 MATTE LACQUERED WHITE  
LACADO BLANCO MATE  
058-058

 NATURAL OAK VENEER  
CHAPA NATURAL ROBLE  
200-200

 NATURAL WALNUT VENEER  
CHAPA NATURAL NOGAL  
800-800

# Mobius Pure

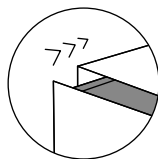
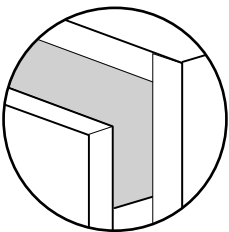

SOFT CLOSE  
SOFT CLOSE

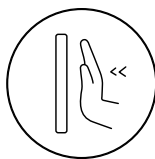

PUSH  
PUSH

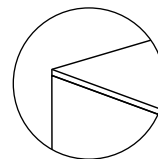

CONCEALED STRUCTURE  
ESTRUCTURA OCULTA

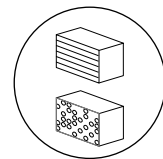

FOR 3D FRONTS SEE P. 84  
FRONTALES 3D VER PG 84





1 DRAWER. DEPTH: 46.5CM  
1 CAJÓN. PROFUNDIDAD 46,5CM

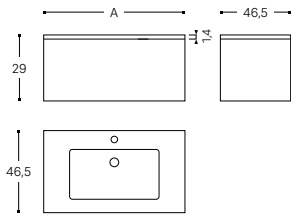

INCH 31,5 x 11,4 x 18,3

A			
63 CM	<b>C220013253</b>	<b>C220013337</b>	<b>C220013362</b>
70 CM	<b>C220013254</b>	<b>C220013338</b>	<b>C220013363</b>
80 CM	<b>C220013255</b>	<b>C220013339</b>	<b>C220013364</b>
90 CM	<b>C220013256</b>	<b>C220013340</b>	<b>C220013365</b>
100 CM	<b>C220013257</b>	<b>C220013341</b>	<b>C220013366</b>
110 CM	<b>C220013258</b>	<b>C220013342</b>	<b>C220013367</b>
120 CM	<b>C220013259</b>	<b>C220013343</b>	<b>C220013368</b>



2 DRAWERS. DEPTH: 46.5CM  
2 CAJONES. PROFUNDIDAD 46,5CM

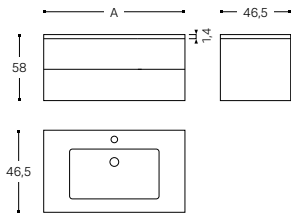

INCH 31,5 x 22,8 x 20,47

A			
63 CM	<b>C220013260</b>	<b>C220013344</b>	<b>C220013369</b>
70 CM	<b>C220013261</b>	<b>C220013345</b>	<b>C220013370</b>
80 CM	<b>C220013262</b>	<b>C220013346</b>	<b>C220013371</b>
90 CM	<b>C220013264</b>	<b>C220013347</b>	<b>C220013372</b>
100 CM	<b>C220013266</b>	<b>C220013348</b>	<b>C220013373</b>
110 CM	<b>C220013267</b>	<b>C220013349</b>	<b>C220013374</b>
120 CM	<b>C220013268</b>	<b>C220013350</b>	<b>C220013375</b>

MATTE LACQUERED WHITE  
LACADO BLANCO MATE  
058-058

NATURAL OAK VENEER  
CHAPA NATURAL ROBLE  
200-200

NATURAL WALNUT VENEER  
CHAPA NATURAL NOGAL  
800-800



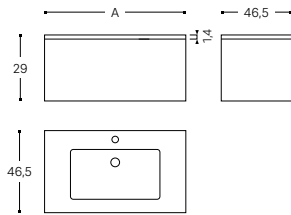

# Mobius Pure



INCH 31,5 x 11,4 x 18,3

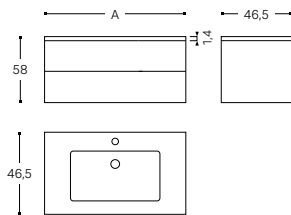

1 DRAWER. DEPTH: 46.5CM  
1 CAJÓN. PROFUNDIDAD 46,5CM

A		
63 CM	<b>C220013387</b>	<b>C220013394</b>
70 CM	<b>C220013388</b>	<b>C220013395</b>
80 CM	<b>C220013389</b>	<b>C220013397</b>
90 CM	<b>C220013390</b>	<b>C220013398</b>
100 CM	<b>C220013391</b>	<b>C220013399</b>
110 CM	<b>C220013392</b>	<b>C220013401</b>
120 CM	<b>C220013393</b>	<b>C220013402</b>



INCH 31,5 x 22,8 x 20,47

2 DRAWERS. DEPTH: 46.5CM  
2 CAJONES. PROFUNDIDAD 46,5CM

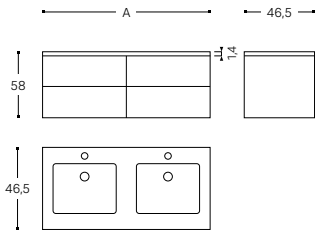

A		
63 CM	<b>C220013403</b>	<b>C220013410</b>
70 CM	<b>C220013404</b>	<b>C220013411</b>
80 CM	<b>C220013405</b>	<b>C220013412</b>
90 CM	<b>C220013406</b>	<b>C220013413</b>
100 CM	<b>C220013407</b>	<b>C220013414</b>
110 CM	<b>C220013408</b>	<b>C220013415</b>
120 CM	<b>C220013409</b>	<b>C220013416</b>

WITH MOBIUS BLOCK SOLIDMAT WASHBASIN / CON LAVABO SOLIDMAT MOBIUS BLOCK



INCH 31,5 x 22,8 x 18,3

4 DRAWERS. DEPTH: 46.5CM  
4 CAJONES. PROFUNDIDAD 46,5CM

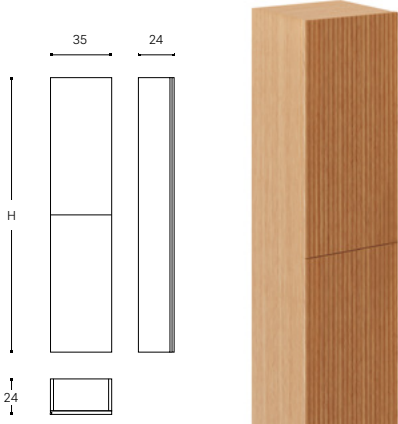

A		
140 CM	<b>C220013417</b>	<b>C220013424</b>
150 CM	<b>C220013418</b>	<b>C220013425</b>
160 CM	<b>C220013419</b>	<b>C220013426</b>
170 CM	<b>C220013420</b>	<b>C220013427</b>
180 CM	<b>C220013421</b>	<b>C220013428</b>
190 CM	<b>C220013422</b>	<b>C220013429</b>
200 CM	<b>C220013423</b>	<b>C220013430</b>



INCH 13.7x63x9.45



COLUMN. DEPTH: 24CM  
COLUMNA. PROFUNDIDAD 24CM

H		
150 CM	<b>C220013431</b>	<b>C220013435</b>
160 CM	<b>C220013432</b>	<b>C220013436</b>
170 CM	<b>C220013433</b>	<b>C220013437</b>
180 CM	<b>C220013434</b>	<b>C220013438</b>

\* Price includes Mobius Block Solidmat washbasin with tap and plug holes and white click clack waste. Made-to-measure and customisable using our configuration tool.  
\*\* No handle. Made-to-measure and customisable using our configuration tool.  
\*\*\* Prices calculated by mm, not in sections. For other sizes please check the configuration tool.

\* Precios con lavabo Solidmat Mobius Block, con agujero para grifo y sifón y válvula click clack blanco. Mueble a medida y personalizable a través del configurador.  
\*\* Sin tirador. Mueble a medida y personalizable a través del configurador.  
\*\*\* Precio calculado al mm. No por tramos, para otras medidas consultar configurador.



# Integrated washbasins

## Lavabos integrados

**Create your own bathroom at [mobiusbycosmic.com](http://mobiusbycosmic.com)**  
**Crea tu propio baño en [mobiusbycosmic.com](http://mobiusbycosmic.com)**

A configuration tool to design your bathroom

With Mobius there are no standard models, but a configuration tool to create the furniture that best suits your project. No limits.

Go to [www.mobiusbycosmic.com](http://www.mobiusbycosmic.com) and start imagining.

Un configurador para crear tu baño

En Mobius no hay modelos estándar, sino un configurador para que crees el mueble que mejor se adapta a tu proyecto. Sin límites.

Entra en [www.mobiusbycosmic.com](http://www.mobiusbycosmic.com) y empieza a imaginar.



**Stone**



**Mondrian**



**Gesto**



**Block**



**Texture**



# Countertop washbasins

## Lavabos sobre encimera

### Mobius Oval



MOBIUS OVAL WASHBASIN  
LAVABO MOBIUS OVAL  
**68x13x43 CM**

REFERENCE  
REFERENCIA

WJM0LEL1003500

FINISH  
ACABADO

Matte white  
Solidmat  
Solidmat  
blanco mate

### Mobius Bowl



MOBIUS BOWL WASHBASIN  
LAVABO MOBIUS BOWL  
**43x13x43 CM**

REFERENCE  
REFERENCIA

WJM0LEL1004500

FINISH  
ACABADO

Matte white  
Solidmat  
Solidmat  
blanco mate



## Mobius Bound



MOBIUS BOUND SHALLOW WASHBASIN  
LAVABO MOBIUS BOUND BAJO  
**36x12x36 CM**

REFERENCE REFERENCIA	FINISH ACABADO
WJM0LEL1005500	Matte white Solidmat blanco mate

## Cube



MOBIUS CUBE WASHBASIN  
LAVABO MOBIUS CUBE  
**38x12x38 CM**

REFERENCE REFERENCIA	FINISH ACABADO
WJM0LEL1007000	White Carrara Blanco carrara
WJM0LEL1008000	Black Marquina Negro Marquina
WJM0LEL1009000	Ivory Marfil
WJM0LEL1010000	Emperor Brown Marrón emperador
WJM0LEL1011000	India Green Verde india
WJM0LEL1012000	Stone Grey Pietra gris

## Mobius Rettan



MOBIUS RETTAN SMALL BOWL WASHBASIN  
LAVABO MOBIUS RETTAN SENO PEQUEÑO  
**45x11x35 CM**

REFERENCE REFERENCIA	FINISH ACABADO
WJM0LEL1001500	Matte white Solidmat blanco mate



MOBIUS RETTAN LARGE BOWL WASHBASIN  
LAVABO MOBIUS RETTAN SENO GRANDE  
**50x11x35 CM**

REFERENCE REFERENCIA	FINISH ACABADO
WJM0LEL1002500	Matte white Solidmat blanco mate



# Index of references

## Índice de referencias

REFERENCES REFERENCIAS	PAGE PÁGINA	REFERENCES REFERENCIAS	PAGE PÁGINA	REFERENCES REFERENCIAS	PAGE PÁGINA
WJB005A0007001	B-BEST	369	WJB010P0615232	B-BEST	353
WJB005A0007001	LIGHT	399	WJB010P0810102	B-BEST	357
WJB005A0008001	B-BEST	369	WJB010P0810194	B-BEST	357
WJB005A0008001	LIGHT	399	WJB010P0810229	B-BEST	357
WJB005A0014001	B-BEST	369	WJB010P0810232	B-BEST	357
WJB005A0014001	LIGHT	399	WJB010P0811102	B-BEST	355
WJB005A0015001	B-BEST	369	WJB010P0811194	B-BEST	355
WJB005A0015001	LIGHT	399	WJB010P0811229	B-BEST	355
WJB005A0102002	ARCHITECT	40	WJB010P0811232	B-BEST	355
WJB005A0102002	CLUSTERS	248	WJB010P0812102	B-BEST	359
WJB005A0102002	B-BEST	352	WJB010P0812194	B-BEST	359
WJB005M0001000	B-BEST	368	WJB010P0812229	B-BEST	359
WJB005M0001000	MIRRORS	407	WJB010P0812232	B-BEST	359
WJB005M0002000	B-BEST	368	WJB010P0814102	B-BEST	365
WJB005M0002000	MIRRORS	407	WJB010P0814194	B-BEST	365
WJB005M0003000	B-BEST	368	WJB010P0814229	B-BEST	365
WJB005M0003000	MIRRORS	407	WJB010P0814232	B-BEST	365
WJB005M0004000	B-BEST	368	WJB010P1001102	B-BEST	360
WJB005M0004000	MIRRORS	407	WJB010P1001194	B-BEST	360
WJB005M0005000	B-BEST	368	WJB010P1001229	B-BEST	360
WJB005M0005000	MIRRORS	407	WJB010P1001232	B-BEST	360
WJB005M0006000	B-BEST	368	WJB010P1011102	B-BEST	358
WJB005M0006000	MIRRORS	407	WJB010P1011194	B-BEST	358
WJB005M0007000	B-BEST	368	WJB010P1011229	B-BEST	358
WJB005M0007000	MIRRORS	407	WJB010P1011232	B-BEST	358
WJB005M0008000	B-BEST	368	WJB010P1012102	B-BEST	356
WJB005M0008000	MIRRORS	407	WJB010P1012194	B-BEST	356
WJB005M0009000	MIRRORS	408	WJB010P1012229	B-BEST	356
WJB010M0005102	B-BEST	367	WJB010P1012232	B-BEST	356
WJB010M0005194	B-BEST	367	WJB010P1013102	B-BEST	359
WJB010M0005229	B-BEST	367	WJB010P1013194	B-BEST	359
WJB010M0005232	B-BEST	367	WJB010P1013229	B-BEST	359
WJB010M0040001	B-BEST	367	WJB010P1013232	B-BEST	359
WJB010P0100102	B-BEST	363	WJB010P1014102	B-BEST	365
WJB010P0100194	B-BEST	363	WJB010P1014194	B-BEST	365
WJB010P0100229	B-BEST	363	WJB010P1014229	B-BEST	365
WJB010P0100232	B-BEST	363	WJB010P1014232	B-BEST	365
WJB010P0101102	B-BEST	367	WJB010P1015102	B-BEST	352
WJB010P0101194	B-BEST	367	WJB010P1015194	B-BEST	352
WJB010P0101229	B-BEST	367	WJB010P1015229	B-BEST	352
WJB010P0101232	B-BEST	367	WJB010P1015232	B-BEST	352
WJB010P0601102	B-BEST	360	WJB010P1201102	B-BEST	361
WJB010P0601194	B-BEST	360	WJB010P1201194	B-BEST	361
WJB010P0601229	B-BEST	360	WJB010P1201229	B-BEST	361
WJB010P0601232	B-BEST	360	WJB010P1201232	B-BEST	361
WJB010P0610102	B-BEST	357	WJB010P1211102	B-BEST	358
WJB010P0610194	B-BEST	357	WJB010P1211194	B-BEST	358
WJB010P0610229	B-BEST	357	WJB010P1211229	B-BEST	358
WJB010P0610232	B-BEST	357	WJB010P1211232	B-BEST	358
WJB010P0611102	B-BEST	355	WJB010P1212102	B-BEST	356
WJB010P0611194	B-BEST	355	WJB010P1212194	B-BEST	356
WJB010P0611229	B-BEST	355	WJB010P1212229	B-BEST	356
WJB010P0611232	B-BEST	355	WJB010P1212232	B-BEST	356
WJB010P0613102	B-BEST	364	WJB010P1213102	B-BEST	366
WJB010P0613194	B-BEST	364	WJB010P1213194	B-BEST	366
WJB010P0613229	B-BEST	364	WJB010P1213229	B-BEST	366
WJB010P0613232	B-BEST	364	WJB010P1213232	B-BEST	366
WJB010P0615102	B-BEST	353	WJB010P1215102	B-BEST	354
WJB010P0615194	B-BEST	353	WJB010P1215194	B-BEST	354
WJB010P0615229	B-BEST	353	WJB010P1215229	B-BEST	354
WJB010P1215232	B-BEST	354	WJB010P1615102	B-BEST	352
WJB010P1615102	B-BEST	352	WJB010P1615194	B-BEST	352
WJB010P1615194	B-BEST	352	WJB010P1615229	B-BEST	352
WJB010P1615229	B-BEST	352	WJB010P1615232	B-BEST	352
WJB010P1801102	B-BEST	360	WJB010P1801102	B-BEST	360
WJB010P1801194	B-BEST	360	WJB010P1801194	B-BEST	360
WJB010P1801229	B-BEST	360	WJB010P1801229	B-BEST	360
WJB010P1801232	B-BEST	360	WJB010P1801232	B-BEST	360
WJB010P1815102	B-BEST	352	WJB010P1815102	B-BEST	352
WJB010P1815194	B-BEST	352	WJB010P1815194	B-BEST	352
WJB010P1815229	B-BEST	352	WJB010P1815229	B-BEST	352
WJB010P1815232	B-BEST	352	WJB010P1815232	B-BEST	352
WJB010P2001102	B-BEST	361	WJB010P2001102	B-BEST	361
WJB010P2001194	B-BEST	361	WJB010P2001194	B-BEST	361
WJB010P2001229	B-BEST	361	WJB010P2001229	B-BEST	361
WJB010P2001232	B-BEST	361	WJB010P2001232	B-BEST	361
WJB010P2015102	B-BEST	353	WJB010P2015102	B-BEST	353
WJB010P2015194	B-BEST	353	WJB010P2015194	B-BEST	353
WJB010P2015229	B-BEST	353	WJB010P2015229	B-BEST	353
WJB010P2015232	B-BEST	353	WJB010P2015232	B-BEST	353
WJB010P2100102	B-BEST	364	WJB010P2100102	B-BEST	364
WJB010P2100194	B-BEST	364	WJB010P2100194	B-BEST	364
WJB010P2100229	B-BEST	364	WJB010P2100229	B-BEST	364
WJB010P2100232	B-BEST	364	WJB010P2100232	B-BEST	364
WJB010P2201102	B-BEST	360	WJB010P2201102	B-BEST	360
WJB010P2201194	B-BEST	360	WJB010P2201194	B-BEST	360
WJB010P2201229	B-BEST	360	WJB010P2201229	B-BEST	360
WJB010P2201232	B-BEST	360	WJB010P2201232	B-BEST	360
WJB010P2215102	B-BEST	353	WJB010P2215102	B-BEST	353
WJB010P2215194	B-BEST	353	WJB010P2215194	B-BEST	353
WJB010P2215229	B-BEST	353	WJB010P2215229	B-BEST	353
WJB010P2215232	B-BEST	353	WJB010P2215232	B-BEST	353
WJB010P2601102	B-BEST	361	WJB010P2601102	B-BEST	361
WJB010P2601194	B-BEST	361	WJB010P2601194	B-BEST	361
WJB010P2601229	B-BEST	361	WJB010P2601229	B-BEST	361
WJB010P2601232	B-BEST	361	WJB010P2601232	B-BEST	361
WJB010P2801102	B-BEST	361	WJB010P2801102	B-BEST	361
WJB010P2801194	B-BEST	361	WJB010P2801194	B-BEST	361
WJB010P2801229	B-BEST	361	WJB010P2801229	B-BEST	361
WJB010P2801232	B-BEST	361	WJB010P2801232	B-BEST	361
WJB010P2815102	B-BEST	353	WJB010P2815102	B-BEST	353
WJB010P2815194	B-BEST	353	WJB010P2815194	B-BEST	353
WJB010P2815229	B-BEST	353	WJB010P2815229	B-BEST	353
WJB010P2815232	B-BEST	353	WJB010P2815232	B-BEST	353
WJB010P3001102	B-BEST	362	WJB010P3001102	B-BEST	362
WJB010P3001194	B-BEST	362	WJB010P3001194	B-BEST	362
WJB010P3001229	B-BEST	362	WJB010P3001229	B-BEST	362
WJB010P3001232	B-BEST	362	WJB010P3001232	B-BEST	362
WJB010P3015102	B-BEST	354	WJB010P3015102	B-BEST	354
WJB010P3015194	B-BEST	354	WJB010P3015194	B-BEST	354
WJB010P3015229	B-BEST	354	WJB010P3015229	B-BEST	354
WJB010P3015232	B-BEST	354	WJB010P3015232	B-BEST	354
WJB010P3801102	B-BEST	362	WJB010P3801102	B-BEST	362
WJB010P3801194	B-BEST	362	WJB010P3801194	B-BEST	362
WJB010P3801229	B-BEST	362	WJB010P3801229	B-BEST	362
WJB010P3801232	B-BEST	362	WJB010P3801232	B-BEST	362
WJB010P3815102	B-BEST	354	WJB010P3815102	B-BEST	354
WJB010P3815194	B-BEST	354	WJB010P3815194	B-BEST	354
WJB010P3815229	B-BEST	354	WJB010P3815229	B-BEST	354

**REFERENCIAS**  
**REFERENCIAS**

S **PAGE**  
**PÁGINA**

WJB010P3815232	B-BEST	354
WJB010P6100102	B-BEST	362
WJB010P6100194	B-BEST	362
WJB010P6100229	B-BEST	362
WJB010P6100232	B-BEST	362
WJB010P8100102	B-BEST	363
WJB010P8100194	B-BEST	363
WJB010P8100229	B-BEST	363
WJB010P8100232	B-BEST	363
WJB010P8103102	B-BEST	366
WJB010P8103194	B-BEST	366
WJB010P8103229	B-BEST	366
WJB010P8103232	B-BEST	366
WJB262A0000001	DUO	103
WJB262A0000001	CLUSTERS	244
WJB262A0001001	DUO	103
WJB262A0001001	CLUSTERS	244
WJB262A0005001	DUO	102
WJB262A0005001	CLUSTERS	233
WJB262A0021001	DUO	102
WJB262A0021001	CLUSTERS	247
WJB262A0041001	DUO	102
WJB262A0041001	CLUSTERS	260
WJB262A0041001	CLUSTERS	261
WJB262A0042001	DUO	102
WJB262A0042001	CLUSTERS	258
WJB262A0044001	DUO	102
WJB262A0045001	DUO	102
WJB262A0049001	DUO	102
WJB262A0049001	CLUSTERS	258
WJB262A0052001	DUO	102
WJB262A0052001	CLUSTERS	237
WJB262A0056001	DUO	103
WJB262A0056001	CLUSTERS	257
WJB262A0057001	DUO	103
WJB262A0059001	DUO	103
WJB262A0059001	CLUSTERS	252
WJB262A0063001	DUO	102
WJB262A0064001	DUO	102
WJB262A0065001	DUO	103
WJB262A0068001	DUO	103
WJB262A0072001	DUO	103
WJB264A0000001	DUO	107
WJB264A0000001	CLUSTERS	244
WJB264A0001001	DUO	107
WJB264A0001001	CLUSTERS	244
WJB264A0005001	DUO	106
WJB264A0005001	CLUSTERS	233
WJB264A0021001	DUO	106
WJB264A0021001	CLUSTERS	247
WJB264A0041001	DUO	106
WJB264A0041001	CLUSTERS	260
WJB264A0042001	DUO	106
WJB264A0042001	CLUSTERS	258
WJB264A0044001	DUO	106
WJB264A0045001	DUO	106
WJB264A0049001	DUO	106
WJB264A0049001	CLUSTERS	258
WJB264A0052001	DUO	106
WJB264A0052001	CLUSTERS	237

**REFERENCIAS**  
**REFERENCIAS**

S **PAGE**  
**PÁGINA**

WJB264A0056001	DUO	107
WJB264A0056001	CLUSTERS	257
WJB264A0057001	DUO	107
WJB264A0059001	DUO	107
WJB264A0059001	CLUSTERS	252
WJB264A0063001	DUO	106
WJB264A0064001	DUO	106
WJB264A0065001	DUO	107
WJB264A0068001	DUO	107
WJB264A0072001	DUO	107
WJB269A0000001	LINE	158
WJB269A0000001	CLUSTERS	243
WJB269A0002001	LINE	159
WJB269A0002001	CLUSTERS	262
WJB269A0002002	LINE	159
WJB269A0002002	CLUSTERS	262
WJB269A0004001	LINE	156
WJB269A0004001	CLUSTERS	231
WJB269A00021001	LINE	156
WJB269A00021001	CLUSTERS	250
WJB269A0049001	LINE	156
WJB269A0049001	START	205
WJB269A0049001	CLUSTERS	259
WJB269A0050001	LINE	156
WJB269A0050001	START	205
WJB269A0050001	CLUSTERS	260
WJB269A0053001	LINE	156
WJB269A0053001	CLUSTERS	236
WJB269A0058001	LINE	158
WJB269A0058001	CLUSTERS	256
WJB269A0059001	LINE	158
WJB269A0059001	CLUSTERS	253
WJB269A0064001	LINE	157
WJB269A0065001	LINE	157
WJB269A0068001	LINE	158
WJB269A0071001	LINE	158
WJB275A0021001	DIABOLO	96
WJB275A0021001	CLUSTERS	247
WJB275A0021036	DIABOLO	96
WJB275A0021036	CLUSTERS	247
WJB275A0021065	DIABOLO	96
WJB275A0021065	CLUSTERS	247
WJB275A0058001	DIABOLO	96
WJB275A0058001	CLUSTERS	254
WJB275A0064001	DIABOLO	96
WJB275A1058001	DIABOLO	96
WJB275A1058001	CLUSTERS	254
WJB275A1064001	DIABOLO	96
WJB275A2058001	DIABOLO	96
WJB275A2058001	CLUSTERS	254
WJB275A2064001	DIABOLO	96
WJB276A0001001	STICK	217
WJB276A0001001	CLUSTERS	244
WJB276A0001036	STICK	217
WJB276A0001036	CLUSTERS	244
WJB276A0001065	STICK	217
WJB276A0001065	CLUSTERS	244
WJB276A0003001	STICK	213
WJB276A0003001	CLUSTERS	233
WJB276A0003036	STICK	213

**REFERENCIAS**  
**REFERENCIAS**

S **PAGE**  
**PÁGINA**

WJB276A0003036	CLUSTERS	233
WJB276A0003065	STICK	213
WJB276A0003065	CLUSTERS	233
WJB276A0021001	STICK	212
WJB276A0021001	CLUSTERS	247
WJB276A0021036	STICK	212
WJB276A0021036	CLUSTERS	247
WJB276A0021065	STICK	212
WJB276A0021065	CLUSTERS	247
WJB276A0022001	STICK	212
WJB276A0022001	CLUSTERS	251
WJB276A0022036	STICK	212
WJB276A0022036	CLUSTERS	251
WJB276A0022065	STICK	212
WJB276A0022065	CLUSTERS	251
WJB276A0023001	STICK	212
WJB276A0023001	CLUSTERS	264
WJB276A0023036	STICK	212
WJB276A0023036	CLUSTERS	264
WJB276A0023065	STICK	212
WJB276A0023065	CLUSTERS	264
WJB276A0044001	STICK	214
WJB276A0044036	STICK	214
WJB276A0044065	STICK	214
WJB276A0049001	STICK	213
WJB276A0049001	CLUSTERS	258
WJB276A0049036	STICK	213
WJB276A0049036	CLUSTERS	258
WJB276A0049065	STICK	213
WJB276A0049065	CLUSTERS	258
WJB276A0053001	STICK	213
WJB276A0053001	CLUSTERS	237
WJB276A0053036	STICK	213
WJB276A0053036	CLUSTERS	237
WJB276A0053065	STICK	213
WJB276A0053065	CLUSTERS	237
WJB276A0058001	STICK	217
WJB276A0058001	CLUSTERS	254
WJB276A0058036	STICK	217
WJB276A0058036	CLUSTERS	254
WJB276A0058065	STICK	217
WJB276A0058065	CLUSTERS	254
WJB276A0059001	STICK	216
WJB276A0059001	CLUSTERS	252
WJB276A0059036	STICK	216
WJB276A0059036	CLUSTERS	252
WJB276A0059065	STICK	216
WJB276A0059065	CLUSTERS	252
WJB276A0063001	STICK	214
WJB276A0063036	STICK	214
WJB276A0063065	STICK	214
WJB276A0064001	STICK	214
WJB276A0064036	STICK	214
WJB276A0064065	STICK	214
WJB276A0065001	STICK	214
WJB276A0065036	STICK	214
WJB276A0065065	STICK	214
WJB276A0066001	STICK	216
WJB276A0066001	CLUSTERS	264
WJB276A0066036	STICK	216

**REFERENCES  
REFERENCIAS**

**§ PAGE  
PÁGINA**

WJB276A0066036	CLUSTERS	264
WJB276A0066065	STICK	216
WJB276A0066065	CLUSTERS	264
WJB276A0067001	STICK	216
WJB276A0067001	CLUSTERS	264
WJB276A0067036	STICK	216
WJB276A0067036	CLUSTERS	264
WJB276A0067065	STICK	216
WJB276A0067065	CLUSTERS	264
WJB276A0069001	STICK	214
WJB276A0069036	STICK	214
WJB276A0069065	STICK	214
WJB276A0071001	STICK	216
WJB276A0071036	STICK	216
WJB276A0071065	STICK	216
WJB276A0096001	STICK	216
WJB276A0096001	CLUSTERS	254
WJB276A0096036	STICK	216
WJB276A0096036	CLUSTERS	254
WJB276A0096065	STICK	216
WJB276A0096065	CLUSTERS	254
WJB350A0001003	LINE	158
WJB350A0001003	CLUSTERS	243
WJB350A0001036	LINE	158
WJB350A0001036	CLUSTERS	243
WJB350A0001065	LINE	158
WJB350A0001065	CLUSTERS	243
WJB350A0004003	LINE	156
WJB350A0004003	CLUSTERS	231
WJB350A0004036	LINE	156
WJB350A0004036	CLUSTERS	231
WJB350A0004065	LINE	156
WJB350A0004065	CLUSTERS	231
WJB350A0021003	LINE	156
WJB350A0021003	CLUSTERS	250
WJB350A0021036	LINE	156
WJB350A0021036	CLUSTERS	250
WJB350A0021065	LINE	156
WJB350A0021065	CLUSTERS	250
WJB350A0051003	LINE	156
WJB350A0051003	CLUSTERS	236
WJB350A0051036	LINE	156
WJB350A0051036	CLUSTERS	236
WJB350A0051065	LINE	156
WJB350A0051065	CLUSTERS	236
WJB350A0058003	LINE	158
WJB350A0058003	CLUSTERS	256
WJB350A0058036	LINE	158
WJB350A0058036	CLUSTERS	256
WJB350A0064003	LINE	157
WJB350A0064036	LINE	157
WJB350A0064065	LINE	157
WJC002A0001036	CLUSTERS	262
WJC002A0001065	CLUSTERS	262
WJC002A0001090	CLUSTERS	262
WJC002A0002036	CLUSTERS	263
WJC002A0002065	CLUSTERS	263
WJC002A0002090	CLUSTERS	263
WJC002A0003003	CLUSTERS	263
WJC205A0004001	ARCHITECT	§ 41
WJC205A0004001	AS+	§ 61
WJC205A0004001	CLUSTERS	§ 230
WJC205A0004003	AS+	61
WJC205A0004003	CLUSTERS	230
WJC205A0004036	AS+	61

**REFERENCES  
REFERENCIAS**















































**§ PAGE  
PÁGINA**

WJC205A0004036	CLUSTERS	230
WJC205A0004040	AS+	61
WJC205A0004040	CLUSTERS	230
WJC205A0004054	AS+	61
WJC205A0004054	CLUSTERS	230
WJC205A0004055	AS+	61
WJC205A0004055	CLUSTERS	230
WJC205A0004065	AS+	61
WJC205A0004065	CLUSTERS	230
WJC205A0004065	CLUSTERS	230
WJC205A0006036	ARCHITECT	49
WJC205A0006036	CLUSTERS	266
WJC205A0006065	ARCHITECT	49
WJC205A0006065	CLUSTERS	266
WJC205A0010001	ARCHITECT	46
WJC205A0010001	CLUSTERS	268
WJC205A0010001	CLUSTERS	269
WJC205A0011001	ARCHITECT	46
WJC205A0011001	CLUSTERS	269
WJC205A0012001	ARCHITECT	46
WJC205A0012001	CLUSTERS	269
WJC205A0013001	ARCHITECT	46
WJC205A0013001	CLUSTERS	269
WJC205A0014001	ARCHITECT	46
WJC205A0014001	CLUSTERS	269
WJC205A0015001	ARCHITECT	46
WJC205A0015001	CLUSTERS	269
WJC205A0016001	ARCHITECT	46
WJC205A0016001	CLUSTERS	269
WJC205A0017001	ARCHITECT	46
WJC205A0017001	CLUSTERS	270
WJC205A0018001	ARCHITECT	46
WJC205A0018001	CLUSTERS	270
WJC205A0020001	ARCHITECT	40
WJC205A0021001	ARCHITECT	§ 40
WJC205A0021001	AS+	§ 59
WJC205A0021001	CLUSTERS	§ 248
WJC205A0021003	AS+	59
WJC205A0021003	CLUSTERS	248
WJC205A0021036	AS+	59
WJC205A0021036	CLUSTERS	248
WJC205A0021040	AS+	59
WJC205A0021040	CLUSTERS	248
WJC205A0021054	AS+	59
WJC205A0021054	CLUSTERS	248
WJC205A0021055	AS+	59
WJC205A0021055	CLUSTERS	248
WJC205A0021065	AS+	59
WJC205A0021065	CLUSTERS	248
WJC205A0022001	ARCHITECT	41
WJC205A0022001	CLUSTERS	251
WJC205A0026001	ARCHITECT	46
WJC205A0026001	CLUSTERS	269
WJC205A0030002	ARCHITECT	42
WJC205A0030002	CLUSTERS	260
WJC205A0034006	ARCHITECT	49
WJC205A0034006	CLUSTERS	271
WJC205A0039002	ARCHITECT	42
WJC205A0039002	CLUSTERS	258
WJC205A0048001	ARCHITECT	42
WJC205A0048001	CLUSTERS	258
WJC205A0049001	ARCHITECT	42
WJC205A0049001	CLUSTERS	258
WJC205A0050001	ARCHITECT	42
WJC205A0050001	CLUSTERS	260
WJC205A0051001	ARCHITECT	41
WJC205A0051001	AS+	62
WJC205A0051001	CLUSTERS	235

**REFERENCES  
REFERENCIAS**

**§ PAGE  
PÁGINA**

WJC205A0051040	AS+	62
WJC205A0051040	CLUSTERS	235
WJC205A0051054	AS+	62
WJC205A0051054	CLUSTERS	235
WJC205A0051055	AS+	62
WJC205A0051055	CLUSTERS	235
WJC205A0051065	AS+	62
WJC205A0051065	CLUSTERS	235
WJC205A0057001	ARCHITECT	47
WJC205A0058001	ARCHITECT	47
WJC205A0058001	CLUSTERS	255
WJC205A0059001	ARCHITECT	47
WJC205A0059001	CLUSTERS	252
WJC205A0061001	ARCHITECT	44
WJC205A0064001	ARCHITECT	43
WJC205A0065001	ARCHITECT	44
WJC205A0066001	ARCHITECT	44
WJC205A0067001	ARCHITECT	43
WJC205A0068001	ARCHITECT	45
WJC205A0069001	ARCHITECT	43
WJC205A0071001	ARCHITECT	45
WJC205A0072001	ARCHITECT	45
WJC205A0074001	ARCHITECT	44
WJC205A0096001	ARCHITECT	47
WJC205A0121001	ARCHITECT	40
WJC205A0121001	BWC	84
WJC205A0121001	CLUSTERS	248
WJC205A0702002	ARCHITECT	48
WJC205A0702002	CLUSTERS	262
WJC205A0703002	ARCHITECT	48
WJC205A0703002	CLUSTERS	262
WJC205A0704002	ARCHITECT	48
WJC205A0704002	CLUSTERS	262
WJC205A1003001	ARCHITECT	§ 41
WJC205A1003001	AS+	§ 61
WJC205A1003001	CLUSTERS	§ 233
WJC205A1003003	AS+	61
WJC205A1003003	CLUSTERS	233
WJC205A1003036	AS+	61
WJC205A1003036	CLUSTERS	233
WJC205A1003040	AS+	61
WJC205A1003040	CLUSTERS	233
WJC205A1003054	AS+	61
WJC205A1003054	CLUSTERS	233
WJC205A1003055	AS+	61
WJC205A1003055	CLUSTERS	233
WJC205A1003065	AS+	61
WJC205A1003065	CLUSTERS	233
WJC205A1020001	ARCHITECT	42
WJC205A1020001	CLUSTERS	268
WJC205A1021001	ARCHITECT	40
WJC205A1021001	AS+	59
WJC205A1021001	CLUSTERS	248
WJC205A1053001	ARCHITECT	41
WJC205A1053001	AS+	63
WJC205A1053001	CLUSTERS	237
WJC205A1053003	AS+	63
WJC205A1053003	CLUSTERS	237
WJC205A1053036	AS+	63
WJC205A1053036	CLUSTERS	238
WJC205A1053040	AS+	63
WJC205A1053040	CLUSTERS	237
WJC205A1053054	AS+	63
WJC205A1053054	CLUSTERS	238
WJC205A1053055	AS+	63
WJC205A1053055	CLUSTERS	238
WJC205A1053065	AS+	63

REFERENCIAS REFERENCIAS		 PAGE PÁGINA	REFERENCIAS REFERENCIAS		 PAGE PÁGINA	REFERENCIAS REFERENCIAS		 PAGE PÁGINA
WJC205A1053065	CLUSTERS	237	WJC215A0064036	NEXT	196	WJC219A0034418	SAONA	27
WJC205A1068001	ARCHITECT	45	WJC215A0065001	NEXT	197	WJC219A0034418	CLUSTERS	239
WJC213A0004345	LIDO	25	WJC215A0065036	NEXT	197	WJC219A0051222	SAONA	27
WJC213A0004345	CLUSTERS	230	WJC215A0068001	NEXT	197	WJC219A0051222	CLUSTERS	235
WJC213A0004420	LIDO	25	WJC215A0068036	NEXT	197	WJC219A0051403	SAONA	27
WJC213A0004420	CLUSTERS	230	WJC215A0071001	NEXT	197	WJC219A0051403	CLUSTERS	235
WJC213A0051345	LIDO	25	WJC215A0071036	NEXT	197	WJC219A0051418	SAONA	27
WJC213A0051345	CLUSTERS	235	WJC215A0075001	NEXT	197	WJC219A0051418	CLUSTERS	235
WJC213A0051420	LIDO	25	WJC215A0075036	NEXT	197	WJC226A0001002	ARCHITECT	 47
WJC213A0051420	CLUSTERS	235	WJC215A0096001	NEXT	197	WJC226A0001002	LOGIC	 171
WJC215A0000001	NEXT	197	WJC215A0096036	NEXT	197	WJC226A0001002	START	 206
WJC215A0000001	START	206	WJC216A0001080	AVENIR	23	WJC226A0001002	CLUSTERS	 242
WJC215A0000001	CLUSTERS	244	WJC216A0001080	CLUSTERS	242	WJC226A0001003	LOGIC	 171
WJC215A0000036	NEXT	197	WJC216A0001080	CLUSTERS	243	WJC226A0001003	CLUSTERS	 242
WJC215A0000036	START	206	WJC216A0001080	CLUSTERS	244	WJC226A0001036	LOGIC	 171
WJC215A0000036	CLUSTERS	244	WJC216A0001081	AVENIR	23	WJC226A0001036	START	 206
WJC215A0001001	NEXT	197	WJC216A0001081	CLUSTERS	242	WJC226A0001036	CLUSTERS	 243
WJC215A0001001	START	206	WJC216A0001082	AVENIR	23	WJC226A0003002	LOGIC	 165
WJC215A0001001	CLUSTERS	242	WJC216A0001082	CLUSTERS	242	WJC226A0003002	START	 205
WJC215A0001036	NEXT	197	WJC216A0001083	AVENIR	23	WJC226A0003002	CLUSTERS	 237
WJC215A0001036	START	206	WJC216A0001083	CLUSTERS	242	WJC226A0003003	LOGIC	165
WJC215A0001036	CLUSTERS	242	WJC216A0004080	AVENIR	23	WJC226A0003003	CLUSTERS	237
WJC215A0004001	NEXT	196	WJC216A0004080	CLUSTERS	228	WJC226A0003036	LOGIC	 165
WJC215A0004001	START	202	WJC216A0004080	CLUSTERS	230	WJC226A0003036	START	 205
WJC215A0004001	CLUSTERS	230	WJC216A0004080	CLUSTERS	231	WJC226A0003036	CLUSTERS	 237
WJC215A0004036	NEXT	196	WJC216A0004081	AVENIR	23	WJC226A0004002	LOGIC	 165
WJC215A0004036	START	202	WJC216A0004081	CLUSTERS	228	WJC226A0004002	START	 202
WJC215A0004036	CLUSTERS	230	WJC216A0004082	AVENIR	23	WJC226A0004002	CLUSTERS	 233
WJC215A0005001	NEXT	196	WJC216A0004082	CLUSTERS	228	WJC226A0004003	LOGIC	 165
WJC215A0005001	START	202	WJC216A0004083	AVENIR	23	WJC226A0004003	CLUSTERS	 233
WJC215A0005001	CLUSTERS	231	WJC216A0004083	CLUSTERS	228	WJC226A0004036	LOGIC	 165
WJC215A0005036	NEXT	196	WJC216A00034080	AVENIR	23	WJC226A0004036	START	 202
WJC215A0005036	START	202	WJC216A00034080	CLUSTERS	238	WJC226A0004036	CLUSTERS	 233
WJC215A0005036	CLUSTERS	231	WJC216A00034080	CLUSTERS	239	WJC226A0021002	LOGIC	 164
WJC215A0021001	NEXT	196	WJC216A0034081	AVENIR	23	WJC226A0021002	CLUSTERS	 247
WJC215A0021001	CLUSTERS	247	WJC216A0034081	CLUSTERS	238	WJC226A0021003	LOGIC	 164
WJC215A0021036	NEXT	196	WJC216A0034082	AVENIR	23	WJC226A0021003	CLUSTERS	 247
WJC215A0021036	CLUSTERS	247	WJC216A0034082	CLUSTERS	238	WJC226A0021036	LOGIC	 164
WJC215A0022001	NEXT	196	WJC216A0034083	AVENIR	23	WJC226A0021036	CLUSTERS	 247
WJC215A0022001	CLUSTERS	250	WJC216A0034083	CLUSTERS	238	WJC226A0030003	LOGIC	 166
WJC215A0022001	CLUSTERS	251	WJC216A0053080	AVENIR	23	WJC226A0030003	CLUSTERS	 260
WJC215A0022036	NEXT	196	WJC216A0053080	CLUSTERS	234	WJC226A0030036	LOGIC	166
WJC215A0022036	CLUSTERS	250	WJC216A0053080	CLUSTERS	235	WJC226A0030036	CLUSTERS	260
WJC215A0052001	NEXT	196	WJC216A0053080	CLUSTERS	236	WJC226A0039003	LOGIC	166
WJC215A0052001	START	205	WJC216A0053081	AVENIR	23	WJC226A0039003	CLUSTERS	258
WJC215A0052001	CLUSTERS	237	WJC216A0053081	CLUSTERS	234	WJC226A0039036	LOGIC	 166
WJC215A0052036	NEXT	196	WJC216A0053082	AVENIR	23	WJC226A0039036	CLUSTERS	 258
WJC215A0052036	START	205	WJC216A0053082	CLUSTERS	234	WJC226A0043002	LOGIC	 167
WJC215A0052036	CLUSTERS	237	WJC216A0053083	AVENIR	23	WJC226A0043003	LOGIC	 167
WJC215A0053001	NEXT	196	WJC216A0053083	CLUSTERS	234	WJC226A0043036	LOGIC	 167
WJC215A0053001	START	202	WJC219A0001222	SAONA	27	WJC226A0045002	LOGIC	167
WJC215A0053001	CLUSTERS	235	WJC219A0001222	CLUSTERS	242	WJC226A0045003	LOGIC	167
WJC215A0053036	NEXT	196	WJC219A0001403	SAONA	27	WJC226A0045036	LOGIC	167
WJC215A0053036	START	202	WJC219A0001403	CLUSTERS	242	WJC226A0046002	LOGIC	167
WJC215A0053036	CLUSTERS	235	WJC219A0001418	SAONA	27	WJC226A0046003	LOGIC	 167
WJC215A0058001	NEXT	197	WJC219A0001418	CLUSTERS	242	WJC226A0046036	LOGIC	 167
WJC215A0058001	CLUSTERS	254	WJC219A0004222	SAONA	27	WJC226A0051002	LOGIC	165
WJC215A0058036	NEXT	197	WJC219A0004222	CLUSTERS	228	WJC226A0051002	START	202
WJC215A0058036	CLUSTERS	254	WJC219A0004403	SAONA	27	WJC226A0051002	CLUSTERS	235
WJC215A0059001	NEXT	197	WJC219A0004403	CLUSTERS	228	WJC226A0051003	AS+	62
WJC215A0059001	CLUSTERS	252	WJC219A0004418	SAONA	27	WJC226A0051003	LOGIC	165
WJC215A0059001	CLUSTERS	253	WJC219A0004418	CLUSTERS	228	WJC226A0051003	CLUSTERS	235
WJC215A0059036	NEXT	197	WJC219A0004418	CLUSTERS	229	WJC226A0051036	AS+	 62
WJC215A0059036	CLUSTERS	252	WJC219A0034222	SAONA	27	WJC226A0051036	LOGIC	 165
WJC215A0063001	NEXT	196	WJC219A0034222	CLUSTERS	239	WJC226A0051036	START	 202
WJC215A0063036	NEXT	196	WJC219A0034403	SAONA	27	WJC226A0051036	CLUSTERS	 235
WJC215A0064001	NEXT	196	WJC219A0034403	CLUSTERS	239	WJC226A0053002	LOGIC	 164

**REFERENCES**  
**REFERENCIAS**

§ **PAGE**  
**PÁGINA**

WJC226A0053002	START	§ 202
WJC226A0053002	CLUSTERS	§ 230
WJC226A0053003	LOGIC	§ 164
WJC226A0053003	CLUSTERS	§ 230
WJC226A0053036	LOGIC	§ 164
WJC226A0053036	START	§ 202
WJC226A0053036	CLUSTERS	§ 230
WJC226A0054002	LOGIC	§ 169
WJC226A0054003	LOGIC	§ 169
WJC226A0054036	LOGIC	169
WJC226A0056002	LOGIC	§ 170
WJC226A0056002	CLUSTERS	§ 254
WJC226A0056003	LOGIC	§ 170
WJC226A0056003	CLUSTERS	§ 254
WJC226A0056036	LOGIC	§ 170
WJC226A0056036	CLUSTERS	§ 255
WJC226A0057002	LOGIC	170
WJC226A0057003	LOGIC	170
WJC226A0057036	LOGIC	170
WJC226A0058002	LOGIC	§ 170
WJC226A0058002	CLUSTERS	§ 254
WJC226A0058003	LOGIC	§ 170
WJC226A0058003	CLUSTERS	§ 254
WJC226A0058036	LOGIC	§ 170
WJC226A0058036	CLUSTERS	§ 255
WJC226A0059002	LOGIC	169
WJC226A0059002	CLUSTERS	252
WJC226A0059003	LOGIC	169
WJC226A0059003	CLUSTERS	252
WJC226A0059036	LOGIC	§ 169
WJC226A0059036	CLUSTERS	§ 252
WJC226A0061002	LOGIC	168
WJC226A0061003	LOGIC	168
WJC226A0061036	LOGIC	168
WJC226A0064002	LOGIC	§ 167
WJC226A0064003	LOGIC	§ 167
WJC226A0064036	LOGIC	§ 167
WJC226A0065002	LOGIC	§ 167
WJC226A0065003	LOGIC	§ 167
WJC226A0065036	LOGIC	§ 167
WJC226A0072002	LOGIC	§ 169
WJC226A0072003	LOGIC	§ 169
WJC226A0072036	LOGIC	§ 169
WJC226A0074002	LOGIC	§ 168
WJC226A0074003	LOGIC	§ 168
WJC226A0074036	LOGIC	168
WJC226A0097002	ARCHITECT	§ 47
WJC226A0097002	LOGIC	§ 171
WJC226A0097002	START	§ 206
WJC226A0097002	CLUSTERS	§ 245
WJC226A0097003	LOGIC	§ 171
WJC226A0097003	CLUSTERS	§ 245
WJC226A0097036	LOGIC	§ 171
WJC226A0097036	START	§ 206
WJC226A0097036	CLUSTERS	§ 245
WJC226A0121002	LOGIC	§ 164
WJC226A0121002	CLUSTERS	§ 248
WJC226A0121003	LOGIC	§ 164
WJC226A0121003	CLUSTERS	§ 248
WJC226A0121036	LOGIC	§ 164
WJC226A0121036	CLUSTERS	§ 248
WJC226A0158002	LOGIC	§ 169
WJC226A0158002	CLUSTERS	§ 255
WJC226A0158003	LOGIC	§ 169
WJC226A0158003	CLUSTERS	§ 255
WJC226A0158036	LOGIC	§ 169
WJC226A0158036	CLUSTERS	§ 255

**REFERENCES**  
**REFERENCIAS**





































§ **PAGE**  
**PÁGINA**

WJC226A0159002	LOGIC	169
WJC226A0159002	CLUSTERS	252
WJC226A0159003	LOGIC	169
WJC226A0159003	CLUSTERS	252
WJC226A0159036	LOGIC	169
WJC226A0159036	CLUSTERS	252
WJC229A0004001	BATH LIFE	77
WJC229A0004001	CLUSTERS	231
WJC229A0005001	BATH LIFE	77
WJC229A0005001	CLUSTERS	234
WJC229A0021001	BATH LIFE	77
WJC229A0021001	CLUSTERS	250
WJC229A0051001	BATH LIFE	77
WJC229A0051001	CLUSTERS	236
WJC229A0052001	BATH LIFE	77
WJC229A0052001	CLUSTERS	238
WJC229A0056001	BATH LIFE	79
WJC229A0056001	CLUSTERS	253
WJC229A0062001	BATH LIFE	79
WJC229A0062001	CLUSTERS	256
WJC229A0063001	BATH LIFE	77
WJC229A0064001	BATH LIFE	77
WJC229A0068001	BATH LIFE	79
WJC229A0069001	BATH LIFE	77
WJC229A0071001	BATH LIFE	79
WJC235A0000001	ARCHITECT	§ 48
WJC235A0000001	AS+	§ 72
WJC235A0000001	BWC	§ 90
WJC235A0000001	CLUSTERS	§ 245
WJC235A0000003	AS+	§ 72
WJC235A0000003	CLUSTERS	§ 245
WJC235A0000036	AS+	§ 72
WJC235A0000036	BWC	§ 90
WJC235A0000036	CLUSTERS	§ 245
WJC235A0000040	AS+	72
WJC235A0000040	CLUSTERS	245
WJC235A0000054	AS+	72
WJC235A0000054	CLUSTERS	245
WJC235A0000055	AS+	72
WJC235A0000055	CLUSTERS	245
WJC235A0000065	AS+	72
WJC235A0000065	BWC	90
WJC235A0000065	CLUSTERS	245
WJC235A0001001	ARCHITECT	§ 47
WJC235A0001001	AS+	§ 72
WJC235A0001001	BWC	§ 90
WJC235A0001001	CLUSTERS	§ 243
WJC235A0001003	AS+	§ 72
WJC235A0001003	CLUSTERS	§ 243
WJC235A0001036	AS+	§ 72
WJC235A0001036	BWC	§ 90
WJC235A0001036	CLUSTERS	§ 243
WJC235A0001040	AS+	72
WJC235A0001040	CLUSTERS	243
WJC235A0001054	AS+	72
WJC235A0001054	CLUSTERS	243
WJC235A0001055	AS+	72
WJC235A0001055	CLUSTERS	243
WJC235A0001065	AS+	72
WJC235A0001065	BWC	90
WJC235A0001065	CLUSTERS	243
WJC235A0002001	ARCHITECT	48
WJC235A0002001	AS+	73
WJC235A0002001	CLUSTERS	262
WJC235A0002003	AS+	73
WJC235A0002003	CLUSTERS	262
WJC235A0003001	AS+	61

**REFERENCES**  
**REFERENCIAS**

§ **PAGE**  
**PÁGINA**

WJC235A0003001	CLUSTERS	233
WJC235A0003003	AS+	61
WJC235A0003003	CLUSTERS	233
WJC235A0003036	AS+	61
WJC235A0003036	CLUSTERS	233
WJC235A0021001	ARCHITECT	§ 40
WJC235A0021001	AS+	§ 60
WJC235A0021001	CLUSTERS	§ 248
WJC235A0021003	AS+	§ 60
WJC235A0021003	CLUSTERS	§ 248
WJC235A0021036	AS+	§ 60
WJC235A0021036	CLUSTERS	§ 248
WJC235A0021040	AS+	60
WJC235A0021040	CLUSTERS	248
WJC235A0021054	AS+	60
WJC235A0021054	CLUSTERS	248
WJC235A0021055	AS+	60
WJC235A0021055	CLUSTERS	248
WJC235A0021065	AS+	60
WJC235A0021065	CLUSTERS	248
WJC235A0023001	AS+	59
WJC235A0023003	AS+	59
WJC235A0023036	AS+	59
WJC235A0024001	AS+	§ 70
WJC235A0024001	CLUSTERS	§ 268
WJC235A0024003	AS+	70
WJC235A0024003	CLUSTERS	268
WJC235A0024036	AS+	§ 70
WJC235A0024036	CLUSTERS	§ 268
WJC235A0025001	AS+	70
WJC235A0025001	CLUSTERS	269
WJC235A0025003	AS+	70
WJC235A0025003	CLUSTERS	269
WJC235A0025036	AS+	70
WJC235A0025036	CLUSTERS	269
WJC235A0028002	AS+	65
WJC235A0028003	AS+	65
WJC235A0028036	AS+	65
WJC235A0044001	AS+	65
WJC235A0044003	AS+	65
WJC235A0044036	AS+	65
WJC235A0047001	AS+	65
WJC235A0047001	CLUSTERS	261
WJC235A0047036	AS+	65
WJC235A0047036	CLUSTERS	261
WJC235A0048001	AS+	§ 64
WJC235A0048001	CLUSTERS	§ 261
WJC235A0048003	AS+	§ 64
WJC235A0048003	CLUSTERS	§ 261
WJC235A0048036	AS+	§ 64
WJC235A0048036	CLUSTERS	§ 261
WJC235A0048040	AS+	64
WJC235A0048040	CLUSTERS	261
WJC235A0048054	AS+	64
WJC235A0048054	CLUSTERS	261
WJC235A0048055	AS+	64
WJC235A0048055	CLUSTERS	261
WJC235A0048065	AS+	64
WJC235A0048065	CLUSTERS	261
WJC235A0049001	AS+	63
WJC235A0049001	CLUSTERS	258
WJC235A0049003	AS+	63
WJC235A0049003	CLUSTERS	259
WJC235A0049036	AS+	63
WJC235A0049036	CLUSTERS	259
WJC235A0049040	AS+	63
WJC235A0049040	CLUSTERS	259

REFERENCIAS REFERENCIAS		 PAGE PÁGINA	REFERENCIAS REFERENCIAS		 PAGE PÁGINA	REFERENCIAS REFERENCIAS		 PAGE PÁGINA
WJC235A0049054	AS+	63	WJC235A0064055	AS+	67	WJC238A0021065	BWC	84
WJC235A0049054	CLUSTERS	259	WJC235A0064065	AS+	67	WJC238A0021065	CLUSTERS	249
WJC235A0049055	AS+	63	WJC235A0065001	AS+	67	WJC238A0049036	BWC	86
WJC235A0049055	CLUSTERS	259	WJC235A0065003	AS+	67	WJC238A0049036	CLUSTERS	259
WJC235A0049065	AS+	63	WJC235A0065036	AS+	67	WJC238A0049065	BWC	86
WJC235A0049065	CLUSTERS	259	WJC235A0068001	AS+	 69	WJC238A0049065	CLUSTERS	259
WJC235A0053001	AS+	63	WJC235A0068003	AS+	69	WJC238A0053036	BWC	85
WJC235A0053001	CLUSTERS	237	WJC235A0068036	AS+	 69	WJC238A0053036	CLUSTERS	236
WJC235A0053003	AS+	63	WJC235A0069001	AS+	 66	WJC238A0053065	BWC	85
WJC235A0053003	CLUSTERS	237	WJC235A0069003	AS+	 66	WJC238A0053065	CLUSTERS	236
WJC235A0053036	AS+	63	WJC235A0069036	AS+	 66	WJC238A0054036	BWC	85
WJC235A0053036	CLUSTERS	237	WJC235A0069040	AS+	66	WJC238A0054036	CLUSTERS	238
WJC235A0057001	AS+	71	WJC235A0069054	AS+	66	WJC238A0054065	BWC	85
WJC235A0057003	AS+	71	WJC235A0069055	AS+	66	WJC238A0054065	CLUSTERS	238
WJC235A0057036	AS+	71	WJC235A0069065	AS+	66	WJC238A0058036	BWC	89
WJC235A0058001	AS+	 71	WJC235A0071001	AS+	 69	WJC238A0058036	CLUSTERS	256
WJC235A0058001	CLUSTERS	 255	WJC235A0071003	AS+	 69	WJC238A0058065	BWC	89
WJC235A0058003	AS+	 71	WJC235A0071036	AS+	 69	WJC238A0058065	CLUSTERS	256
WJC235A0058003	CLUSTERS	 255	WJC235A0071040	AS+	69	WJC238A0059036	BWC	89
WJC235A0058036	AS+	 71	WJC235A0071054	AS+	69	WJC238A0059036	CLUSTERS	253
WJC235A0058036	CLUSTERS	 255	WJC235A0071055	AS+	69	WJC238A0059065	BWC	89
WJC235A0058040	AS+	71	WJC235A0071065	AS+	69	WJC238A0059065	CLUSTERS	253
WJC235A0058040	CLUSTERS	255	WJC235A0075001	AS+	68	WJC238A0064036	BWC	87
WJC235A0058054	AS+	71	WJC235A0075003	AS+	68	WJC238A0064065	BWC	87
WJC235A0058054	CLUSTERS	255	WJC235A0075036	AS+	68	WJC238A0065036	BWC	87
WJC235A0058055	AS+	71	WJC235A0085001	ARCHITECT	 43	WJC238A0065065	BWC	87
WJC235A0058055	CLUSTERS	255	WJC235A0085001	AS+	 65	WJC238A0068036	BWC	88
WJC235A0058065	AS+	71	WJC235A0085001	CLUSTERS	 240	WJC238A0068065	BWC	88
WJC235A0058065	CLUSTERS	255	WJC235A0085003	AS+	 65	WJC238A0071036	BWC	88
WJC235A0059001	AS+	 70	WJC235A0085003	CLUSTERS	 240	WJC238A0071065	BWC	88
WJC235A0059001	CLUSTERS	 252	WJC235A0085036	AS+	 65	WJC238A0075036	BWC	88
WJC235A0059003	AS+	 70	WJC235A0085036	CLUSTERS	 240	WJC238A0075065	BWC	88
WJC235A0059003	CLUSTERS	 252	WJC235A0085040	AS+	65	WJC238A0083036	BWC	86
WJC235A0059036	AS+	 70	WJC235A0085040	CLUSTERS	240	WJC238A0083036	CLUSTERS	241
WJC235A0059036	CLUSTERS	 253	WJC235A0085054	AS+	65	WJC238A0083065	BWC	86
WJC235A0059040	AS+	70	WJC235A0085054	CLUSTERS	240	WJC238A0083065	CLUSTERS	241
WJC235A0059040	CLUSTERS	252	WJC235A0085055	AS+	65	WJC238A0085036	BWC	86
WJC235A0059054	AS+	70	WJC235A0085055	CLUSTERS	240	WJC238A0085036	CLUSTERS	240
WJC235A0059054	CLUSTERS	253	WJC235A0085065	AS+	65	WJC238A0085065	BWC	86
WJC235A0059055	AS+	70	WJC235A0085065	CLUSTERS	240	WJC238A0085065	CLUSTERS	240
WJC235A0059055	CLUSTERS	253	WJC235A0096001	AS+	71	WJC238A0158036	BWC	90
WJC235A0059065	AS+	70	WJC235A0096003	AS+	71	WJC238A0158036	CLUSTERS	256
WJC235A0059065	CLUSTERS	252	WJC235A0096036	AS+	71	WJC238A0158065	BWC	90
WJC235A0060001	AS+	68	WJC235A0097001	AS+	72	WJC238A0158065	CLUSTERS	256
WJC235A0060003	AS+	68	WJC235A0097001	CLUSTERS	265	WJC251A0000001	ARCHITECT	48
WJC235A0060036	AS+	68	WJC235A0097036	AS+	72	WJC251A0000001	BWC	90
WJC235A0061001	AS+	68	WJC235A0097036	CLUSTERS	265	WJC251A0000001	CLUSTERS	246
WJC235A0061003	AS+	68	WJC235A0097040	AS+	72	WJC251A0004001	BWC	84
WJC235A0061036	AS+	68	WJC235A0097040	CLUSTERS	265	WJC251A0004001	CLUSTERS	230
WJC235A0062001	AS+	71	WJC235A0097065	AS+	72	WJC251A0005001	BWC	84
WJC235A0062001	CLUSTERS	255	WJC235A0097065	CLUSTERS	265	WJC251A0005001	CLUSTERS	234
WJC235A0062003	AS+	71	WJC238A0000036	BWC	90	WJC251A0021001	BWC	84
WJC235A0062003	CLUSTERS	255	WJC238A0000036	CLUSTERS	246	WJC251A0021001	CLUSTERS	249
WJC235A0062036	AS+	71	WJC238A0000065	BWC	90	WJC251A0024001	BWC	88
WJC235A0062036	CLUSTERS	255	WJC238A0000065	CLUSTERS	246	WJC251A0024001	CLUSTERS	268
WJC235A0063001	AS+	 67	WJC238A0004036	BWC	84	WJC251A0025001	BWC	88
WJC235A0063003	AS+	 67	WJC238A0004036	CLUSTERS	231	WJC251A0025001	CLUSTERS	268
WJC235A0063036	AS+	 67	WJC238A0004065	BWC	84	WJC251A0032001	BWC	86
WJC235A0063040	AS+	67	WJC238A0004065	CLUSTERS	230	WJC251A0032001	CLUSTERS	239
WJC235A0063054	AS+	67	WJC238A0005036	BWC	84	WJC251A0034001	BWC	86
WJC235A0063055	AS+	67	WJC238A0005036	CLUSTERS	234	WJC251A0034001	CLUSTERS	239
WJC235A0063065	AS+	67	WJC238A0005065	BWC	84	WJC251A0049051	ARCHITECT	42
WJC235A0064001	AS+	 67	WJC238A0005065	CLUSTERS	234	WJC251A0049051	BWC	86
WJC235A0064003	AS+	 67	WJC238A0020036	BWC	84	WJC251A0049051	CLUSTERS	259
WJC235A0064036	AS+	 67	WJC238A0020065	BWC	84	WJC251A0049061	ARCHITECT	42
WJC235A0064040	AS+	67	WJC238A0021036	BWC	84	WJC251A0049061	BWC	86
WJC235A0064054	AS+	67	WJC238A0021036	CLUSTERS	249	WJC251A0049061	EXTREME	120



**REFERENCES  
REFERENCIAS**

**S PAGE  
PÁGINA**

WJC251A0049061	CLUSTERS	259
WJC251A0053001	BWC	85
WJC251A0053001	CLUSTERS	236
WJC251A0054001	BWC	85
WJC251A0054001	CLUSTERS	238
WJC251A0058001	BWC	90
WJC251A0058001	CLUSTERS	256
WJC251A0059001	BWC	89
WJC251A0059001	EXTREME	123
WJC251A0059001	CLUSTERS	253
WJC251A0062001	BWC	87
WJC251A0064001	BWC	87
WJC251A0065001	BWC	87
WJC251A0068001	BWC	88
WJC251A0071001	BWC	88
WJC251A0075001	BWC	88
WJC251A0097001	BWC	90
WJC251A0097001	CLUSTERS	265
WJC251A0098001	BWC	89
WJC251A0098001	CLUSTERS	268
WJC251A0099001	BWC	89
WJC251A0099001	CLUSTERS	268
WJC252A0000025	SAKU	32
WJC252A0000025	CLUSTERS	242
WJC252A0000026	SAKU	32
WJC252A0000026	CLUSTERS	242
WJC252A0000027	SAKU	32
WJC252A0000027	CLUSTERS	242
WJC252A0000028	SAKU	32
WJC252A0000028	CLUSTERS	242
WJC252A0004025	SAKU	32
WJC252A0004025	CLUSTERS	228
WJC252A0004026	SAKU	32
WJC252A0004026	CLUSTERS	228
WJC252A0004027	SAKU	32
WJC252A0004027	CLUSTERS	228
WJC252A0004028	SAKU	32
WJC252A0004028	CLUSTERS	228
WJC252A00032025	SAKU	32
WJC252A00032025	CLUSTERS	238
WJC252A00032026	SAKU	32
WJC252A00032026	CLUSTERS	238
WJC252A00032027	SAKU	32
WJC252A00032027	CLUSTERS	238
WJC252A00032028	SAKU	32
WJC252A00032028	CLUSTERS	238
WJC252A00052025	SAKU	32
WJC252A00052025	CLUSTERS	234
WJC252A00052026	SAKU	32
WJC252A00052026	CLUSTERS	234
WJC252A00052027	SAKU	32
WJC252A00052027	CLUSTERS	234
WJC252A00052028	SAKU	32
WJC252A00052028	CLUSTERS	234
WJC253A0000001	BATH LIFE	79
WJC253A0000001	EXTREME	123
WJC253A0000001	CLUSTERS	245
WJC253A0001001	BATH LIFE	79
WJC253A0001001	EXTREME	123
WJC253A0001001	CLUSTERS	243
WJC253A0004001	EXTREME	120
WJC253A0004001	CLUSTERS	231
WJC253A0005001	EXTREME	120
WJC253A0005001	CLUSTERS	234
WJC253A0021001	EXTREME	120
WJC253A0021001	CLUSTERS	250
WJC253A0032001	EXTREME	120

**REFERENCES  
REFERENCIAS**



**S PAGE  
PÁGINA**

WJC253A0032001	CLUSTERS	239
WJC253A0052001	EXTREME	120
WJC253A0052001	CLUSTERS	238
WJC253A0053001	EXTREME	120
WJC253A0053001	CLUSTERS	236
WJC253A0058001	EXTREME	123
WJC253A0058001	CLUSTERS	256
WJC253A0063001	EXTREME	120
WJC253A0064001	EXTREME	120
WJC253A0065001	EXTREME	120
WJC253A0066001	EXTREME	123
WJC253A0075001	EXTREME	123
WJC268A0000001	THE GRID	223
WJC268A0000001	CLUSTERS	246
WJC268A0000036	THE GRID	223
WJC268A0000036	CLUSTERS	246
WJC268A0000065	THE GRID	223
WJC268A0000065	CLUSTERS	246
WJC268A0001001	THE GRID	223
WJC268A0001001	CLUSTERS	245
WJC268A0001036	THE GRID	223
WJC268A0001036	CLUSTERS	246
WJC268A0001065	THE GRID	223
WJC268A0001065	CLUSTERS	245
WJC268A0004001	THE GRID	221
WJC268A0004001	CLUSTERS	228
WJC268A0004036	THE GRID	221
WJC268A0004036	CLUSTERS	228
WJC268A0004065	THE GRID	221
WJC268A0004065	CLUSTERS	228
WJC268A0021001	THE GRID	221
WJC268A0021001	CLUSTERS	250
WJC268A0021036	THE GRID	221
WJC268A0021036	CLUSTERS	250
WJC268A0021065	THE GRID	221
WJC268A0021065	CLUSTERS	250
WJC268A0058001	THE GRID	223
WJC268A0058001	CLUSTERS	256
WJC268A0058036	THE GRID	223
WJC268A0058036	CLUSTERS	256
WJC268A0058065	THE GRID	223
WJC268A0058065	CLUSTERS	256
WJC268A0059001	THE GRID	223
WJC268A0059001	CLUSTERS	253
WJC268A0059036	THE GRID	223
WJC268A0059036	CLUSTERS	253
WJC268A0059065	THE GRID	223
WJC268A0059065	CLUSTERS	253
WJC268A0063001	THE GRID	221
WJC268A0063036	THE GRID	221
WJC268A0063065	THE GRID	221
WJC268A0065001	THE GRID	221
WJC268A0065036	THE GRID	221
WJC268A0065065	THE GRID	221
WJC268A0071001	THE GRID	223
WJC268A0071036	THE GRID	223
WJC268A0071065	THE GRID	223
WJC268A0074001	THE GRID	221
WJC268A0074036	THE GRID	221
WJC268A0074065	THE GRID	221
WJC277A0000036	GEYSER	136
WJC277A0000036	CLUSTERS	242
WJC277A0000065	GEYSER	136
WJC277A0000065	CLUSTERS	242
WJC277A0000088	GEYSER	136
WJC277A0000088	CLUSTERS	242
WJC277A0000089	GEYSER	136

**REFERENCES  
REFERENCIAS**

**S PAGE  
PÁGINA**

WJC277A0000089	CLUSTERS	242
WJC277A0000090	GEYSER	136
WJC277A0000090	CLUSTERS	242
WJC277A0001036	GEYSER	136
WJC277A0001036	CLUSTERS	244
WJC277A0001065	GEYSER	136
WJC277A0001065	CLUSTERS	244
WJC277A0001088	GEYSER	136
WJC277A0001088	CLUSTERS	244
WJC277A0001088	CLUSTERS	245
WJC277A0001088	CLUSTERS	246
WJC277A0001089	GEYSER	136
WJC277A0001089	CLUSTERS	244
WJC277A0001090	GEYSER	136
WJC277A0001090	CLUSTERS	244
WJC277A0002036	AS+	73
WJC277A0002036	GEYSER	136
WJC277A0002036	CLUSTERS	262
WJC277A0002036	CLUSTERS	263
WJC277A0002065	GEYSER	136
WJC277A0002065	CLUSTERS	262
WJC277A0002087	GEYSER	136
WJC277A0002087	CLUSTERS	262
WJC277A0004036	GEYSER	129
WJC277A0004036	CLUSTERS	228
WJC277A0004065	GEYSER	129
WJC277A0004065	CLUSTERS	228
WJC277A0004088	GEYSER	129
WJC277A0004088	CLUSTERS	228
WJC277A0004089	GEYSER	129
WJC277A0004089	CLUSTERS	228
WJC277A0004090	GEYSER	129
WJC277A0004090	CLUSTERS	228
WJC277A0005036	GEYSER	130
WJC277A0005036	CLUSTERS	231
WJC277A0005065	GEYSER	130
WJC277A0005065	CLUSTERS	231
WJC277A0005088	GEYSER	130
WJC277A0005088	CLUSTERS	233
WJC277A0005088	CLUSTERS	234
WJC277A0005089	GEYSER	130
WJC277A0005089	CLUSTERS	231
WJC277A0005090	GEYSER	130
WJC277A0005090	CLUSTERS	231
WJC277A0006036	GEYSER	137
WJC277A0006036	CLUSTERS	266
WJC277A0006065	GEYSER	137
WJC277A0006065	CLUSTERS	266
WJC277A0006088	GEYSER	137
WJC277A0006088	CLUSTERS	266
WJC277A0006089	GEYSER	137
WJC277A0006089	CLUSTERS	266
WJC277A0006090	GEYSER	137
WJC277A0006090	CLUSTERS	266
WJC277A0022036	GEYSER	129
WJC277A0022036	CLUSTERS	247
WJC277A0022065	GEYSER	129
WJC277A0022065	CLUSTERS	247
WJC277A0022088	GEYSER	129
WJC277A0022088	CLUSTERS	247
WJC277A0022088	CLUSTERS	248
WJC277A0022088	CLUSTERS	249
WJC277A0022088	CLUSTERS	250
WJC277A0022089	GEYSER	129
WJC277A0022089	CLUSTERS	247
WJC277A0022090	GEYSER	129

REFERENCIAS REFERENCIAS		 PAGE PÁGINA	REFERENCIAS REFERENCIAS		 PAGE PÁGINA	REFERENCIAS REFERENCIAS		 PAGE PÁGINA
WJC277A0022090	CLUSTERS	247	WJC277A0071090	GEYSER	135	WJC292A0111222	CLUSTERS	227
WJC277A0032036	GEYSER	132	WJC277A0084036	GEYSER	133	WJC341R0387000	LAGOON	309
WJC277A0032036	CLUSTERS	239	WJC277A0084036	CLUSTERS	241	WJC341R0387000	MOD	345
WJC277A0032065	GEYSER	132	WJC277A0084065	GEYSER	133	WJC341R0387000	COMPACT	377
WJC277A0032065	CLUSTERS	239	WJC277A0084065	CLUSTERS	241	WJC341R0387000	FANCY	390
WJC277A0032088	GEYSER	132	WJC277A0084088	GEYSER	133	WJC341R0590000	COMPACT	377
WJC277A0032088	CLUSTERS	239	WJC277A0084088	CLUSTERS	241	WJC341R0786000	LAGOON	309
WJC277A0032089	GEYSER	132	WJC277A0084089	GEYSER	133	WJC341R0786000	COMPACT	376
WJC277A0032089	CLUSTERS	239	WJC277A0084089	CLUSTERS	241	WJC341R0786000	FANCY	390
WJC277A0032090	GEYSER	132	WJC277A0084090	GEYSER	133	WJC341R0787000	LAGOON	309
WJC277A0032090	CLUSTERS	239	WJC277A0084090	CLUSTERS	241	WJC341R0787000	COMPACT	376
WJC277A0033036	GEYSER	132	WJC281A8133000	MIRRORS	408	WJC341R0787000	FANCY	390
WJC277A0033036	CLUSTERS	258	WJC281A8144000	MIRRORS	408	WJC341R0789000	LAGOON	309
WJC277A0033065	GEYSER	132	WJC281A8145000	MIRRORS	408	WJC341R0789000	MOD	345
WJC277A0033065	CLUSTERS	258	WJC281A8146000	MIRRORS	408	WJC341R0789000	COMPACT	377
WJC277A0033088	GEYSER	132	WJC281A8147000	MIRRORS	408	WJC341R0789000	FANCY	390
WJC277A0033088	CLUSTERS	258	WJC281A8150000	MIRRORS	409	WJC341R0790000	LAGOON	309
WJC277A0033088	CLUSTERS	259	WJC290A0003000	ARCHITECT	42	WJC341R0790000	MOD	345
WJC277A0033088	CLUSTERS	260	WJC290A0003000	CLUSTERS	268	WJC341R0790000	COMPACT	377
WJC277A0033089	GEYSER	132	WJC290A0025002	ARCHITECT	41	WJC341R0790000	FANCY	390
WJC277A0033089	CLUSTERS	258	WJC290A0025002	CLUSTERS	233	WJC341R0791000	COMPACT	377
WJC277A0033090	GEYSER	132	WJC290A0025002	CLUSTERS	268	WJC341R0791000	FANCY	391
WJC277A0033090	CLUSTERS	258	WJC290A0026002	ARCHITECT	48	WJC341R0792000	COMPACT	377
WJC277A0051036	GEYSER	131	WJC290A0026002	CLUSTERS	270	WJC341R0792000	FANCY	391
WJC277A0051036	CLUSTERS	235	WJC290A0027002	ARCHITECT	48	WJC341R1185000	ARCHITECT	49
WJC277A0051065	GEYSER	131	WJC290A0027002	CLUSTERS	270	WJC341R1185000	GEYSER	137
WJC277A0051065	CLUSTERS	235	WJC290A0028001	ARCHITECT	48	WJC341R1185000	KUBIC	150
WJC277A0051088	GEYSER	131	WJC290A0028001	CLUSTERS	270	WJC341R7600000	LAGOON	309
WJC277A0051088	CLUSTERS	235	WJC290A0028036	ARCHITECT	48	WJC341R7600000	COMPACT	376
WJC277A0051089	GEYSER	131	WJC290A0028036	CLUSTERS	270	WJC341R7600000	FANCY	390
WJC277A0051089	CLUSTERS	235	WJC290A6509000	ARCHITECT	42	WJC419A0000001	START	206
WJC277A0051090	GEYSER	131	WJC290A6510000	ARCHITECT	42	WJC419A0000001	CLUSTERS	244
WJC277A0051090	CLUSTERS	235	WJC290A6523000	CLUSTERS	262	WJC419A0000036	START	206
WJC277A0052036	GEYSER	131	WJC292A0000001	ARCHITECT	48	WJC419A0000036	CLUSTERS	244
WJC277A0052036	CLUSTERS	237	WJC292A0000001	LOGIC	171	WJC419A0005001	START	202
WJC277A0052065	GEYSER	131	WJC292A0000001	CLUSTERS	246	WJC419A0005001	CLUSTERS	231
WJC277A0052065	CLUSTERS	236	WJC292A0000036	ARCHITECT	48	WJC419A0005001	CLUSTERS	232
WJC277A0052088	GEYSER	131	WJC292A0000036	LOGIC	171	WJC419A0005036	START	202
WJC277A0052088	CLUSTERS	236	WJC292A0000036	CLUSTERS	246	WJC419A0005036	CLUSTERS	233
WJC277A0052088	CLUSTERS	237	WJC292A0002036	AS+	73	WJC419A0021001	START	202
WJC277A0052088	CLUSTERS	238	WJC292A0002036	START	207	WJC419A0021001	CLUSTERS	247
WJC277A0052089	GEYSER	131	WJC292A0002036	CLUSTERS	262	WJC419A0021036	START	202
WJC277A0052089	CLUSTERS	236	WJC292A0003036	CLUSTERS	262	WJC419A0021036	CLUSTERS	247
WJC277A0052090	GEYSER	131	WJC292A0004036	CLUSTERS	262	WJC419A0022001	START	202
WJC277A0052090	CLUSTERS	236	WJC292A0083001	ARCHITECT	43	WJC419A0022001	CLUSTERS	250
WJC277A0062036	GEYSER	135	WJC292A0083001	CLUSTERS	240	WJC419A0022036	START	202
WJC277A0062036	CLUSTERS	254	WJC292A0083036	ARCHITECT	43	WJC419A0022036	CLUSTERS	250
WJC277A0062065	GEYSER	135	WJC292A0083036	CLUSTERS	240	WJC419A0030001	START	205
WJC277A0062065	CLUSTERS	254	WJC292A0084001	ARCHITECT	43	WJC419A0030001	CLUSTERS	258
WJC277A0062088	GEYSER	135	WJC292A0084001	CLUSTERS	240	WJC419A0030036	START	205
WJC277A0062088	CLUSTERS	254	WJC292A0084036	ARCHITECT	43	WJC419A0030036	CLUSTERS	258
WJC277A0062088	CLUSTERS	255	WJC292A0084036	CLUSTERS	240	WJC419A0032001	START	205
WJC277A0062088	CLUSTERS	256	WJC292A0085001	CLUSTERS	241	WJC419A0032001	CLUSTERS	239
WJC277A0062088	CLUSTERS	257	WJC292A0085036	CLUSTERS	241	WJC419A0032036	START	205
WJC277A0062089	GEYSER	135	WJC292A0086001	CLUSTERS	241	WJC419A0032036	CLUSTERS	239
WJC277A0062089	CLUSTERS	254	WJC292A0086036	CLUSTERS	241	WJC419A0044001	START	205
WJC277A0062090	GEYSER	135	WJC292A0087001	CLUSTERS	240	WJC419A0044036	START	205
WJC277A0062090	CLUSTERS	254	WJC292A0087036	CLUSTERS	240	WJC419A0049036	LINE	156
WJC277A0064036	GEYSER	134	WJC292A0088001	CLUSTERS	240	WJC419A0049036	START	205
WJC277A0064065	GEYSER	134	WJC292A0088036	CLUSTERS	240	WJC419A0049036	CLUSTERS	259
WJC277A0064088	GEYSER	134	WJC292A00097036	CLUSTERS	265	WJC419A0050036	LINE	156
WJC277A0064089	GEYSER	134	WJC292A0109222	CLUSTERS	227	WJC419A0050036	START	205
WJC277A0064090	GEYSER	134	WJC292A0109403	CLUSTERS	227	WJC419A0050036	CLUSTERS	260
WJC277A0071036	GEYSER	135	WJC292A0109418	CLUSTERS	227	WJC419A0052001	START	202
WJC277A0071065	GEYSER	135	WJC292A0110222	CLUSTERS	227	WJC419A0052001	CLUSTERS	237
WJC277A0071088	GEYSER	135	WJC292A0110403	CLUSTERS	227	WJC419A0052036	START	202
WJC277A0071089	GEYSER	135	WJC292A0110418	CLUSTERS	227	WJC419A0052036	CLUSTERS	237



REFERENCIAS REFERENCIAS		PAGE PÁGINA	REFERENCIAS REFERENCIAS		PAGE PÁGINA	REFERENCIAS REFERENCIAS		PAGE PÁGINA
WJC780M0260126	WISH	328	WJC781M0002766	LAGOON	293	WJC781M00034766	LAGOON	305
WJC780M0260530	WISH	328	WJC781M0002767	LAGOON	293	WJC781M00035766	LAGOON	305
WJC780M0280108	WISH	329	WJC781M0002768	LAGOON	293	WJC781M00036102	LAGOON	306
WJC780M0280110	WISH	329	WJC781M0003102	LAGOON	293	WJC781M00036116	LAGOON	306
WJC780M0280116	WISH	329	WJC781M0003116	LAGOON	293	WJC781M00036122	LAGOON	306
WJC780M0280126	WISH	329	WJC781M0003122	LAGOON	293	WJC781M00036126	LAGOON	306
WJC780M0280530	WISH	329	WJC781M0003126	LAGOON	293	WJC781M00036535	LAGOON	306
WJC780M0360530	WISH	330	WJC781M0003535	LAGOON	293	WJC781M00036766	LAGOON	306
WJC780M0380530	WISH	330	WJC781M0003766	LAGOON	293	WJC781M00036767	LAGOON	306
WJC780M1100102	WISH	335	WJC781M0003767	LAGOON	293	WJC781M00036768	LAGOON	306
WJC780M1100108	WISH	335	WJC781M0003768	LAGOON	293	WJC781M00037102	LAGOON	306
WJC780M1100110	WISH	335	WJC781M0004102	LAGOON	294	WJC781M00037116	LAGOON	306
WJC780M1100116	WISH	335	WJC781M0004116	LAGOON	294	WJC781M00037122	LAGOON	306
WJC780M1100126	WISH	335	WJC781M0004122	LAGOON	294	WJC781M00037126	LAGOON	306
WJC780M1100205	WISH	335	WJC781M0004126	LAGOON	294	WJC781M00037535	LAGOON	306
WJC780M1100241	WISH	335	WJC781M0004535	LAGOON	294	WJC781M00037766	LAGOON	306
WJC780M1120102	WISH	335	WJC781M0004766	LAGOON	294	WJC781M00037767	LAGOON	306
WJC780M1120108	WISH	335	WJC781M0004767	LAGOON	294	WJC781M00037768	LAGOON	306
WJC780M1120110	WISH	335	WJC781M0004768	LAGOON	294	WJC781M00038102	LAGOON	307
WJC780M1120116	WISH	335	WJC781M0005102	LAGOON	294	WJC781M00038116	LAGOON	307
WJC780M1120126	WISH	335	WJC781M0005116	LAGOON	294	WJC781M00038122	LAGOON	307
WJC780M1120205	WISH	335	WJC781M0005122	LAGOON	294	WJC781M00038126	LAGOON	307
WJC780M1120241	WISH	335	WJC781M0005126	LAGOON	294	WJC781M00038535	LAGOON	307
WJC780M1160102	WISH	336	WJC781M0005535	LAGOON	294	WJC781M00038766	LAGOON	307
WJC780M1160108	WISH	336	WJC781M0005766	LAGOON	294	WJC781M00038767	LAGOON	307
WJC780M1160110	WISH	336	WJC781M0005767	LAGOON	294	WJC781M00038768	LAGOON	307
WJC780M1160116	WISH	336	WJC781M0005768	LAGOON	294	WJC781M00039102	LAGOON	307
WJC780M1160126	WISH	336	WJC781M0006102	LAGOON	295	WJC781M00039116	LAGOON	307
WJC780M1160205	WISH	336	WJC781M0006116	LAGOON	295	WJC781M00039122	LAGOON	307
WJC780M1160241	WISH	336	WJC781M0006122	LAGOON	295	WJC781M00039126	LAGOON	307
WJC780M2100108	WISH	329	WJC781M0006126	LAGOON	295	WJC781M00039535	LAGOON	307
WJC780M2100110	WISH	329	WJC781M0006535	LAGOON	295	WJC781M00039766	LAGOON	307
WJC780M2100116	WISH	329	WJC781M0006766	LAGOON	295	WJC781M00039767	LAGOON	307
WJC780M2100126	WISH	329	WJC781M0006767	LAGOON	295	WJC781M00039768	LAGOON	307
WJC780M2100530	WISH	329	WJC781M0006768	LAGOON	295	WJC781M00042102	LAGOON	302
WJC780M2120108	WISH	330	WJC781M0007102	LAGOON	295	WJC781M00043102	LAGOON	303
WJC780M2120110	WISH	330	WJC781M0007116	LAGOON	295	WJC781M00043766	LAGOON	303
WJC780M2120116	WISH	330	WJC781M0007122	LAGOON	295	WJC781M00043767	LAGOON	303
WJC780M2120126	WISH	330	WJC781M0007126	LAGOON	295	WJC781M00044102	LAGOON	303
WJC780M2120530	WISH	330	WJC781M0007535	LAGOON	295	WJC781M00044766	LAGOON	303
WJC780M3060108	WISH	326	WJC781M0007766	LAGOON	295	WJC781M00044767	LAGOON	303
WJC780M3060110	WISH	326	WJC781M0007767	LAGOON	295	WJC781M00045102	LAGOON	297
WJC780M3060116	WISH	326	WJC781M0007768	LAGOON	295	WJC781M00045116	LAGOON	297
WJC780M3060126	WISH	326	WJC781M0008102	LAGOON	299	WJC781M00045122	LAGOON	297
WJC780M3080108	WISH	326	WJC781M0009102	LAGOON	299	WJC781M00045535	LAGOON	297
WJC780M3080110	WISH	326	WJC781M0010102	LAGOON	299	WJC781M00045766	LAGOON	297
WJC780M3080116	WISH	326	WJC781M0011102	LAGOON	299	WJC781M00046102	LAGOON	297
WJC780M3080126	WISH	326	WJC781M0012102	LAGOON	300	WJC781M00046116	LAGOON	297
WJC780M3100530	WISH	331	WJC781M0013102	LAGOON	300	WJC781M00046122	LAGOON	297
WJC780M3120530	WISH	331	WJC781M0014102	LAGOON	300	WJC781M00046535	LAGOON	297
WJC780M4100108	WISH	326	WJC781M0015102	LAGOON	300	WJC781M00046766	LAGOON	297
WJC780M4100110	WISH	326	WJC781M0016102	LAGOON	300	WJC781M00047102	LAGOON	298
WJC780M4100116	WISH	326	WJC781M0017102	LAGOON	300	WJC781M00047116	LAGOON	298
WJC780M4100126	WISH	326	WJC781M0018766	LAGOON	301	WJC781M00047122	LAGOON	298
WJC781M0001102	LAGOON	292	WJC781M0019766	LAGOON	301	WJC781M00047535	LAGOON	298
WJC781M0001116	LAGOON	292	WJC781M0020766	LAGOON	302	WJC781M00047766	LAGOON	298
WJC781M0001122	LAGOON	292	WJC781M0021766	LAGOON	302	WJC781M00048102	LAGOON	298
WJC781M0001126	LAGOON	292	WJC781M0024102	LAGOON	303	WJC781M00048116	LAGOON	298
WJC781M0001535	LAGOON	292	WJC781M0025102	LAGOON	303	WJC781M00048122	LAGOON	298
WJC781M0001766	LAGOON	292	WJC781M0026102	LAGOON	303	WJC781M00048535	LAGOON	298
WJC781M0001767	LAGOON	292	WJC781M0027102	LAGOON	303	WJC781M00048766	LAGOON	298
WJC781M0001768	LAGOON	292	WJC781M0028102	LAGOON	304	WJC781M00049102	LAGOON	296
WJC781M0002102	LAGOON	293	WJC781M0029102	LAGOON	304	WJC781M00049116	LAGOON	296
WJC781M0002116	LAGOON	293	WJC781M0030766	LAGOON	304	WJC781M00049122	LAGOON	296
WJC781M0002122	LAGOON	293	WJC781M0031766	LAGOON	304	WJC781M00049535	LAGOON	296
WJC781M0002126	LAGOON	293	WJC781M0032766	LAGOON	304	WJC781M00049766	LAGOON	296
WJC781M0002535	LAGOON	293	WJC781M0033766	LAGOON	304	WJC781M00055102	LAGOON	309

**REFERENCES**  
**REFERENCIAS**

**S** **PAGE**  
**PÁGINA**

WJC781M0056766	LAGOON	309
WJC781M0057102	LAGOON	296
WJC781M0057116	LAGOON	296
WJC781M0057122	LAGOON	296
WJC781M0057126	LAGOON	296
WJC781M0057535	LAGOON	296
WJC781M0057766	LAGOON	296
WJC781M0057767	LAGOON	296
WJC781M0057768	LAGOON	296
WJC781M0058102	LAGOON	300
WJC781M0059102	LAGOON	304
WJC781M0060000	LAGOON	308
WJC781M0060000	MIRRORS	403
WJC781M0061000	LAGOON	308
WJC781M0061000	MIRRORS	403
WJC781M0062000	LAGOON	308
WJC781M0062000	MIRRORS	403
WJC781M0063000	LAGOON	308
WJC781M0063000	MIRRORS	403
WJC781M0064000	LAGOON	308
WJC781M0064000	MIRRORS	403
WJC781M0065000	LAGOON	308
WJC781M0065000	MIRRORS	403
WJC781M0066000	LAGOON	308
WJC781M0066000	MIRRORS	403
WJC781M0067000	LAGOON	308
WJC781M0067000	MIRRORS	403
WJC781M0068102	LAGOON	304
WJC781M0108102	LAGOON	299
WJC781M0109102	LAGOON	299
WJC781M0110102	LAGOON	299
WJC781M0111102	LAGOON	299
WJC781M0112102	LAGOON	300
WJC781M0113102	LAGOON	301
WJC781M0114102	LAGOON	301
WJC781M0115102	LAGOON	301
WJC781M0116102	LAGOON	301
WJC781M0117102	LAGOON	301
WJC781M0118766	LAGOON	302
WJC781M0119766	LAGOON	302
WJC781M0120766	LAGOON	302
WJC781M0121766	LAGOON	302
WJC781M0158102	LAGOON	301
WJC781M1001102	LAGOON	290
WJC781M1001116	LAGOON	290
WJC781M1001122	LAGOON	290
WJC781M1001535	LAGOON	290
WJC781M1001766	LAGOON	290
WJC781M1002102	LAGOON	290
WJC781M1002116	LAGOON	290
WJC781M1002122	LAGOON	290
WJC781M1002535	LAGOON	290
WJC781M1002766	LAGOON	290
WJC781M1003102	LAGOON	291
WJC781M1003116	LAGOON	291
WJC781M1003122	LAGOON	291
WJC781M1003535	LAGOON	291
WJC781M1003766	LAGOON	291
WJC781M1004102	LAGOON	291
WJC781M1004116	LAGOON	291
WJC781M1004122	LAGOON	291
WJC781M1004535	LAGOON	291
WJC781M1004766	LAGOON	291
WJC781M1007102	LAGOON	292
WJC781M1007116	LAGOON	292
WJC781M1007122	LAGOON	292
WJC781M1007535	LAGOON	292

**REFERENCES**  
**REFERENCIAS**

**S** **PAGE**  
**PÁGINA**

WJC781M1007766	LAGOON	292
WJC781M1101102	LAGOON	288
WJC781M1101116	LAGOON	288
WJC781M1101122	LAGOON	288
WJC781M1101535	LAGOON	288
WJC781M1101766	LAGOON	288
WJC781M1102102	LAGOON	288
WJC781M1102116	LAGOON	288
WJC781M1102122	LAGOON	288
WJC781M1102535	LAGOON	288
WJC781M1102766	LAGOON	288
WJC781M1103102	LAGOON	289
WJC781M1103116	LAGOON	289
WJC781M1103122	LAGOON	289
WJC781M1103535	LAGOON	289
WJC781M1103766	LAGOON	289
WJC781M1104102	LAGOON	289
WJC781M1104116	LAGOON	289
WJC781M1104122	LAGOON	289
WJC781M1104535	LAGOON	289
WJC781M1104766	LAGOON	289
WJM281A1013000	MIRRORS	408
WJM281A1015000	MIRRORS	408
WJM341R0726000	MOD	342
WJP014A6031001	CLUSTERS	260
WJP014A6032001	CLUSTERS	260
WJP014A6033001	CLUSTERS	260
WJP014A6034001	CLUSTERS	261
WJP014A6123001	CLUSTERS	260
WJP014A6124001	CLUSTERS	260
WJP014A6125001	CLUSTERS	260
WJP014A6132001	CLUSTERS	261
WJP014A6133001	CLUSTERS	261
WJP033A1030001	KUBIC	146
WJP033A1030036	KUBIC	146
WJP033A1040001	KUBIC	147
WJP033A1040036	KUBIC	147
WJP033A1050001	KUBIC	147
WJP033A1060001	KUBIC	147
WJP033A1060036	KUBIC	147
WJP033A1401001	KUBIC	148
WJP033A1442001	KUBIC	148
WJP033A1481001	KUBIC	149
WJP033A1481001	CLUSTERS	255
WJP033A1481036	KUBIC	149
WJP033A1481036	CLUSTERS	255
WJP033A2057001	KUBIC	148
WJP033A2057036	KUBIC	148
WJP033A3001001	KUBIC	144
WJP033A3001001	CLUSTERS	249
WJP033A3001036	KUBIC	144
WJP033A3001036	CLUSTERS	249
WJP033A3011001	KUBIC	143
WJP033A3011001	CLUSTERS	249
WJP033A3011036	KUBIC	143
WJP033A3011036	CLUSTERS	249
WJP033A4011001	KUBIC	142
WJP033A4011001	CLUSTERS	249
WJP033A4011036	KUBIC	142
WJP033A4011036	CLUSTERS	249
WJP033A4042001	KUBIC	149
WJP033A4042036	KUBIC	149
WJP033A5040001	KUBIC	146
WJP033A5060001	KUBIC	146
WJP033A5110001	KUBIC	148
WJP036A0535001	KUBIC	149
WJP036A0535001	CLUSTERS	269

**REFERENCES**  
**REFERENCIAS**

**S** **PAGE**  
**PÁGINA**

WJP036A0536001	KUBIC	148
WJP036A0536001	CLUSTERS	269
WJP036A3011001	KUBIC	143
WJP036A3011001	CLUSTERS	249
WJP036A3011036	KUBIC	143
WJP036A3011036	CLUSTERS	249
WJP036A4005001	KUBIC	149
WJP036A4005001	CLUSTERS	253
WJP036A4005036	KUBIC	149
WJP036A4005036	CLUSTERS	253
WJP036A4011001	KUBIC	142
WJP036A4011001	CLUSTERS	249
WJP036A4011036	KUBIC	142
WJP036A4011036	CLUSTERS	249
WJP036A4012001	KUBIC	149
WJP033A6020001	KUBIC	144
WJP033A6020001	CLUSTERS	259
WJP033A6020036	KUBIC	144
WJP033A6020036	CLUSTERS	259
WJP036A6032001	KUBIC	144
WJP036A6032001	CLUSTERS	260
WJP036A7050001	KUBIC	144
WJP036A7050001	CLUSTERS	236
WJP036A7050036	KUBIC	144
WJP036A7050036	CLUSTERS	236
WJP036A7831001	KUBIC	144
WJP036A7831001	CLUSTERS	230
WJP036A7831036	KUBIC	144
WJP036A7831036	CLUSTERS	230
WJP036A9002001	KUBIC	150
WJP036A9002001	CLUSTERS	245
WJP036A9002036	KUBIC	150
WJP036A9002036	CLUSTERS	245
WJP036A9051001	KUBIC	150
WJP036A9051001	CLUSTERS	243
WJP036A9051036	KUBIC	150
WJP036A9051036	CLUSTERS	243
WJP036A9351001	KUBIC	150
WJP036A9351001	CLUSTERS	262
WJP036A9402001	KUBIC	145
WJP038A1030001	METRIC	178
WJP038A1030036	METRIC	178
WJP038A1040001	METRIC	178
WJP038A1040021	METRIC	178
WJP038A1040036	METRIC	178
WJP038A1060001	METRIC	178
WJP038A1060021	METRIC	178
WJP038A1060036	METRIC	178
WJP038A1442001	METRIC	179
WJP038A1481001	METRIC	177
WJP038A1481021	METRIC	177
WJP038A2005001	METRIC	179
WJP038A2005021	METRIC	179
WJP038A2005036	METRIC	179
WJP038A3001001	METRIC	176
WJP038A3001001	CLUSTERS	250
WJP038A3001021	METRIC	176
WJP038A3001021	CLUSTERS	250
WJP038A3001036	METRIC	176
WJP038A3001036	CLUSTERS	250
WJP038A4001001	METRIC	179
WJP038A4001001	CLUSTERS	256
WJP038A4001021	METRIC	179
WJP038A4001021	CLUSTERS	256
WJP038A4001036	METRIC	179
WJP038A4001036	CLUSTERS	256
WJP038A4002001	METRIC	179

REFERENCIAS REFERENCIAS		S PAGE PÁGINA	REFERENCIAS REFERENCIAS		S PAGE PÁGINA	REFERENCIAS REFERENCIAS		S PAGE PÁGINA
WJP038A4002001	CLUSTERS	257	WJP047A1443001	MICRA	187	WJP056A4002001	CLUSTERS	253
WJP038A4002021	METRIC	179	WJP047A2055001	MICRA	190	WJP056A4002036	EDA	114
WJP038A4002021	CLUSTERS	257	WJP047A2055036	MICRA	190	WJP056A4002036	CLUSTERS	253
WJP038A4002036	METRIC	179	WJP047A3001001	MICRA	187	WJP056A6020001	EDA	114
WJP038A4002036	CLUSTERS	257	WJP047A3001001	CLUSTERS	249	WJP056A6020001	CLUSTERS	260
WJP038A4010001	METRIC	180	WJP047A3001036	MICRA	187	WJP056A6020603	EDA	114
WJP038A4010036	METRIC	180	WJP047A3001036	CLUSTERS	249	WJP056A6020603	CLUSTERS	260
WJP038A4042001	METRIC	180	WJP047A3002001	MICRA	187	WJP056A7050001	EDA	114
WJP038A4042021	METRIC	180	WJP047A3002001	CLUSTERS	251	WJP056A7050001	CLUSTERS	236
WJP038A4042036	METRIC	180	WJP047A3003001	MICRA	187	WJP056A7050036	EDA	114
WJP038A5110001	METRIC	179	WJP047A3003001	CLUSTERS	249	WJP056A7050036	CLUSTERS	236
WJP038A5110036	METRIC	179	WJP047A4001001	MICRA	191	WJP056A7831001	EDA	114
WJP038A6010001	METRIC	177	WJP047A4001001	CLUSTERS	257	WJP056A7831001	CLUSTERS	231
WJP038A6010001	CLUSTERS	259	WJP047A4001036	MICRA	191	WJP056A7831036	EDA	114
WJP038A6010036	METRIC	177	WJP047A4001036	CLUSTERS	257	WJP056A7831036	CLUSTERS	231
WJP038A6010036	CLUSTERS	259	WJP047A4002001	MICRA	190	WJP056A9050001	EDA	115
WJP038A6020001	METRIC	177	WJP047A4002001	CLUSTERS	255	WJP056A9050001	CLUSTERS	244
WJP038A6020001	CLUSTERS	259	WJP047A4002036	MICRA	190	WJP056A9050036	EDA	115
WJP038A6020021	METRIC	177	WJP047A4002036	CLUSTERS	255	WJP056A9050036	CLUSTERS	244
WJP038A6020021	CLUSTERS	259	WJP047A4010001	MICRA	191	WJP056A9350001	EDA	115
WJP038A7001001	METRIC	177	WJP047A4010036	MICRA	191	WJP056A9350001	CLUSTERS	262
WJP038A7001001	CLUSTERS	238	WJP047A5004001	MICRA	189	WJP056A9350603	EDA	115
WJP038A7001021	METRIC	177	WJP047A5110002	MICRA	190	WJP056A9350603	CLUSTERS	262
WJP038A7001021	CLUSTERS	238	WJP047A6020001	MICRA	189	WJP056A9401001	EDA	114
WJP038A7050001	METRIC	177	WJP047A6020001	CLUSTERS	259	WJP056A9401603	EDA	114
WJP038A7050001	CLUSTERS	236	WJP047A6020036	MICRA	189	WJP056A9701000	EDA	114
WJP038A7050021	METRIC	177	WJP047A6020036	CLUSTERS	259	WJP056A9701036	EDA	114
WJP038A7050021	CLUSTERS	236	WJP047A6050001	MICRA	189	WJP077L5502520	EQUILIBRIUM	381
WJP038A7801001	METRIC	176	WJP047A6050001	CLUSTERS	239	WJP341R3101001	KUBIC	151
WJP038A7801001	CLUSTERS	234	WJP047A7001001	MICRA	188	WJP341R3101036	KUBIC	151
WJP038A7801021	METRIC	176	WJP047A7001001	CLUSTERS	238	WJP341R3102001	KUBIC	151
WJP038A7801021	CLUSTERS	234	WJP047A7050001	MICRA	188	WJP341R3102036	KUBIC	151
WJP038A7801036	METRIC	176	WJP047A7050001	CLUSTERS	236	WJP341R3201001	KUBIC	150
WJP038A7801036	CLUSTERS	234	WJP047A7802001	MICRA	188	WJP341R3201036	KUBIC	150
WJP038A7831001	METRIC	176	WJP047A7802001	CLUSTERS	234	WJP341R3202001	KUBIC	151
WJP038A7831001	CLUSTERS	231	WJP047A7802036	MICRA	188	WJP341R3202036	KUBIC	151
WJP038A7831021	METRIC	176	WJP047A7802036	CLUSTERS	234			
WJP038A7831021	CLUSTERS	231	WJP047A7832001	MICRA	187			
WJP038A7831036	METRIC	176	WJP047A7832001	CLUSTERS	230			
WJP038A7831036	CLUSTERS	231	WJP047A7832036	MICRA	187			
WJP038A9001001	METRIC	180	WJP047A7832036	CLUSTERS	230			
WJP038A9001001	CLUSTERS	245	WJP047A9001001	MICRA	191			
WJP038A9001021	METRIC	180	WJP047A9001001	CLUSTERS	245			
WJP038A9001021	CLUSTERS	245	WJP047A9001036	MICRA	191			
WJP038A9001036	METRIC	180	WJP047A9001036	CLUSTERS	245			
WJP038A9001036	CLUSTERS	245	WJP047A9050001	MICRA	191			
WJP038A9050001	METRIC	180	WJP047A9050001	CLUSTERS	243			
WJP038A9050001	CLUSTERS	243	WJP047A9050036	MICRA	191			
WJP038A9050021	METRIC	180	WJP047A9050036	CLUSTERS	243			
WJP038A9050021	CLUSTERS	243	WJP049A1401001	BATH LIFE	77			
WJP038A9050036	METRIC	180	WJP049A3001001	BATH LIFE	77			
WJP038A9050036	CLUSTERS	243	WJP049A3001001	CLUSTERS	250			
WJP043A3011001	KUBIC	143	WJP056A1030001	EDA	114			
WJP043A3011001	CLUSTERS	249	WJP056A1030036	EDA	114			
WJP043A3011036	KUBIC	143	WJP056A1045001	EDA	114			
WJP043A3011036	CLUSTERS	249	WJP056A1045036	EDA	114			
WJP043A4011001	KUBIC	142	WJP056A2005001	EDA	114			
WJP043A4011001	CLUSTERS	249	WJP056A2005036	EDA	114			
WJP043A4011036	KUBIC	142	WJP056A3011001	EDA	114			
WJP043A4011036	CLUSTERS	249	WJP056A3011001	CLUSTERS	250			
WJP047A1030001	MICRA	189	WJP056A3011036	EDA	114			
WJP047A1030036	MICRA	189	WJP056A3011036	CLUSTERS	250			
WJP047A1040001	MICRA	189	WJP056A4001001	EDA	115			
WJP047A1040036	MICRA	189	WJP056A4001001	CLUSTERS	256			
WJP047A1050001	MICRA	190	WJP056A4001036	EDA	115			
WJP047A1050036	MICRA	190	WJP056A4001036	CLUSTERS	256			
WJP047A1401001	MICRA	190	WJP056A4002001	EDA	114			

# Spare parts

## Recambios



[https://www.cosmicbrand.com/documents/d/cosmic/  
Tarifa\\_24\\_REC\\_CATALOGUE](https://www.cosmicbrand.com/documents/d/cosmic/Tarifa_24_REC_CATALOGUE)





# Materials



## FLOAT GLASS (Flat shelves and washbasin tops)

Made using standard FLOAT type glass that has undergone no subsequent treatment other than the necessary machining, cutting and polishing. Therefore, it is a naturally fragile material and despite the fact that the most appropriate density has been used in every case, special care should be taken when using it. 100% recyclable.



## PRESSED GLASS

### (Most of the glasses and soap dishes in our collection)

A very similar material to the FLOAT glass used for the shelves, glasses, and soap dishes, etc. This molten glass is shaped in a mould. These products should be used and cared for in the same way as the shelves and washbasin tops. 100% recyclable.



## TEMPERED GLASS

This material is manufactured similarly to FLOAT glass, but also undergoes a thermal processing to increase its resistance. 100% recyclable.



## MIRRORS

Sheet of glass covered by layers of silver, copper and, finally, paint. The use of topquality raw materials in conjunction with the correct mirror manufacturing process guarantee maximum protection against stains caused by corrosion.



## SYNTHETIC RESIN

Is a technologically advanced and unique compound, made up of high percentage of mineral extenders from nature (ATH derived from bauxite) as well as a small one of high-pureness polyester and acrylic polymers; therefore, it is an inert, hypoallergenic and non-toxic material. 100% recyclable, practically fireproof (class 1), strongly UV-resistant, solid and nonporous, hygienic and healthy, resistant and agreeable to the touch for its velvety and natural.



## CRISTALPLANT BIOBASED®

Material made up of 50% natural minerals (aluminium trihydrate -ATH- derived from bauxite) and 50% high-purity polyester bioresins. Plant resins; this is the first ecologically sustainable solid surface, consisting of resins of plant origin and extremely pure natural minerals. It is an inert, hypoallergenic, non-toxic material. It is practically inflammable, certified Class 1 fire resistance. It is highly resistant to ultraviolet rays. It regains its original appearance with just soapy water and a scrubber.



## PHENOLIC RESIN

This material is a high pressure laminate (HPL) with a decorative surface. Typically the superficial layer consists of thermo-hardened resin-treated plywood. The special texture and durability of this material makes it very resistant to impact and scratching, and it is completely waterproof. Specially designed for use in places where hygiene is of the utmost importance, this material can be cleaned frequently with active detergents, chemical agents, or organic solvents.



## VENEERED WOOD

MDF boards + oak veneer varnished with fine quality materials to prevent yellowing. Oak wood is a material that is very resistant to biological agents (fungus and insects). As this kind of material is natural wood, it may present knots and color variation.



## LACQUERED WOOD

This material is made from double-faced MDF plywood. Its high quality varnish provides a bright or matte finish and prevents yellowing. Due to its delicate lacquered surface, we recommend the use of mild cleaning products, avoiding solvents or any abrasive substances.



## PVC

Polyvinyl chloride (PVC) is a polyvinyl chloride polymer used to manufacture numerous products and is also applied in making boards, panels, windows, shutters, etc. Its durability, colour stability, watertightness and moisture proof properties make PVC an ideal material for bathroom and kitchen furniture. The material can be cleaned quickly and easily with just soap and water, although its resilience means most cleaning products can also be used.



## PLASTIC

We use various technical plastics with different features to meet the manufacturing and aesthetic needs of each product. These include ABS (with or without chrome), PP, PA, PE, PC, PS, etc.



## ACRYLIC GLASS

The polymethylmetacrylate (PMMA) is known as one of the "engineering plastics", and is obtained through the polymerisation of methyl methacrylate. It stands out from other plastics due to the fact that it is impact resistant, weather resistant—as it does not undergo any significant ageing in ten years of outdoor exposure—resistant to UVA rays and scratch resistant. Due to its absolute transparency (it is the most transparent plastic), it is most commonly used in vehicle headlights, optics, medicine or partition panels. For use in architecture and decoration, it is lighter than glass and provides greater resistance to impact, meaning it can be a good substitute in many situations.



## STAINLESS STEEL

It is an alloy of iron and carbon. Steel maintains the iron hardness characteristics. This steel has a special chrome treatment against the rust and oxidation. The used alloys are SS201 & SS304.



## BRASS OR SIMILAR ALLOYS (glossy chrome and matt chrome)

A copper and zinc alloy—this is one of the non-ferrous metals, the proportion of which varies according to its use. It offers greater malleability than both copper and zinc separately, and it is easily refined which allows for a high level of design customization.



## ALUMINUM

Aluminium alloy. May be presented as solid, extruded and calibrated. Aluminium is an important metal for numerous industries, such as the automotive industry where it is most common. It is generally a soft metal with low melting points.



## GLASS-LINED STEEL (VIT-TECH)

Cutting-edge, 100% recyclable, non-porous and hygienic material made of fired pre-enamelled sheet steel. The vitreous enamel withstands corrosion, high temperatures and chemical agents. This durability means it can be used for a wide range of functional applications in bathtubs, shower trays and washbasins, as well as for ovens and coatings. It is an easy to clean material that does not require special cleaning products.





**TECKSTONE**

Advanced formula composed by natural minerals (calcium carbonate and quartz) mixed with resin. The surface is covered by Gelcoat Premium Maxguard™ film, with plastic fibre and polymer, which provides the needed durability and resistance for an intensive daily use. It is a solid surface with excellent physic-mechanical properties that supplies important design possibilities. Its capacity of moulding allows reproducing forms with a great precision and with less curvature radius. Teckstone is very hard, resistant and compact; being a non porous material and without angles, it is very easy to maintain, the stains can be eliminated without effort and it is easy to clean.



**MARBLE**

**Carrara Marble.** Extracted from Italy's Tuscan quarries, each piece of marble is different and each stone has its own unique characteristics. Its white background has distinctive light blue-grey veins running through its surface.

**Marquina Marble.** Elegant and classic, each piece of marble is different and every stone has its own characteristics. Extracted from the quarries sited in Marquina (Vizcaya), it is characterized by its white veins on the black stone. The less veins it has, more appreciated is.

**Brescia Marble.** (Brown matt and glossy) from the region of Lombardy (Italy). It is considered as one of the most sumptuous Italian marble.



**PORCELAIN**

Ceramic product obtained from a sophisticated paste made up of kaolin, feldspar and quartz. Porcelain is treated with a vitrified top finish for surface hardness, colour and sheen. It is non-porous and hygienic, which makes it suitable for use in the bathroom. The vitrified finish means that it can be cleaned with any bathroom-specific product.



**VITREOUS CHINA**

The washbasin is made in a traditional way, it is characterized by high durability, resistance to abrasion and chemical agents.



**FÉNIX®**

Soft touch material and high performance: micro-scratch thermal reparability, anti-fingerprint, scratch resistance, high resistance to solvents and low light reflectivity. FÉNIX® products are made of paper (more than 60%) and thermosetting resins (30-40%). They are created through a pressure process in which heat and pressure are applied simultaneously to obtain a homogeneous non-porous product. The core structure is made of paper, impregnated with thermosetting resins. The outer surface is treated with the latest generation acrylic resins, hardened and set using the Electron Beam Curing process. It does not require any special maintenance, just a damp cloth with warm water or mild detergents. To remove the most common stains the surface can be cleaned with just warm water and a non-abrasive cloth. If the residue is old or has hardened, use a magic eraser sponge or a soft cloth to remove it. Always rinse thoroughly to remove detergent with clean, preferably warm water. Tests have shown that the removal of superficial micro-scratches using a "magic sponge" takes place both immediately and after 24 hours.



**SOLIDMAT**

A solid surface with a high percentage of natural mineral deposits. It stands out for its glossy feel and its durability. It is a fireproof material, compact and non-porous and both hygienic and resistant. Available in solid matt white.

**CLEANING INSTRUCTIONS**

Clean with a liquid domestic cleaner or with soap suds. Afterwards rinse with clear water and polish with a cloth. Do not use any cleaning agents containing acid or scouring agents. Damage caused by improper treatment is not subject to our guarantee.



# Materiales



## VIDRIO FLOAT (Estantes y encimeras)

Realizado con vidrio tipo FLOAT estándar sin ningún otro tratamiento posterior más que la mecanización, corte y pulido necesarios. Se trata, pues, de un material que por su propia naturaleza es frágil y a pesar de que en cada caso se ha utilizado el espesor más adecuado, debe tenerse un especial cuidado en su uso. 100% reciclable.



## VIDRIO PRENSADO (Vasos y jaboneras de la mayoría de nuestras series)

Material muy similar al vidrio FLOAT utilizado en estantes, vasos, jaboneras... Este vidrio fundido es conformado en un molde. El uso y cuidados deben ser los mismos que para estantes y encimeras. 100% reciclable.



## VIDRIO TEMPLADO

Vidrio FLOAT sometido a tratamiento térmico para aumentar su resistencia. 100% reciclable.



## ESPEJOS

Plancha de vidrio sobre la que se aplica una capa de plata, cobre y finalmente pintura. El uso de materia prima de primera calidad, unido a un correcto proceso de fabricación de los espejos, aseguran la mayor protección contra las manchas por corrosión.



## RESINA SINTÉTICA

Es un material compuesto tecnológicamente avanzado y único, formado por un porcentaje elevado de minerales naturales (trihidrato de aluminio -ATH- derivado de la bauxita) y un bajo porcentaje de polímeros poliésteres y acrílicos de gran pureza; se trata, por lo tanto, de un material inerte, hipoalérgico y no tóxico. Es un material que puede reciclarse al 100%, prácticamente ignífugo (clase 1), con una óptima resistencia a los rayos ultravioletas; es compacto, no poroso, higiénico, resistente y agradable al tacto gracias a su acabado aterciopelado, similar al de la piedra natural.



## CRISTALPLANT BIOBASED®

Material compuesto formado por un 50% de minerales naturales (trihidrato de aluminio -ATH- derivado de la bauxita) y un 50% de biorresinas de poliéster de gran pureza. Es el primer solid surface eco sostenible que deriva de materias primas resinosas de origen vegetal, procedentes de cultivos certificados, mezcladas con minerales naturales de extrema pureza. Es un material inerte, hipoalérgico y no tóxico. Es prácticamente ignífugo, con certificado de resistencia al fuego Clase 1. Presenta una óptima resistencia a los rayos ultravioletas. Puede recuperar completamente su aspecto original utilizando simplemente agua jabonosa y estropajos abrasivos.



## RESINA FENÓLICA

La Resina Fenólica o Stratificato es un laminado de alta presión (HPL) con superficie decorativa. En general, la capa superficial está constituida por una superficie dura, basada en resinas de melamina, mientras que el grueso está constituido por un contrachapado impregnado de resina termo endurecida que le confiere al material una excepcional resistencia al impacto. Su especial textura y su durabilidad proporcionan una excelente resistencia al rayado. Gracias a su superficie perfectamente impermeable es un material resistente al desgaste, al agua y al vapor.



## MADERA CHAPADA

Tableros de DM + chapa de roble barnizado con materiales de primera calidad que evitan el amarillamiento. La madera de roble es un material muy resistente a los agentes biológicos (hongos e insectos), al ser una madera natural puede mostrar nudos y presentar variaciones de color entre piezas.



## MADERA LACADA

Tablero DM melaminado dos caras y lacado en acabados brillo y mate con barnices de primera calidad resistentes y que evitan el amarillamiento. Las superficies lacadas son delicadas y deben ser tratadas y limpiadas cuidadosamente, utilizando productos específicos para estas superficies. No usar nunca disolventes o productos abrasivos.



## PVC

El cloruro de polivinilo (PVC) es un polímero de cloruro de vinilo que se emplea para la fabricación de multitud de productos, encontrando aplicación en la realización de tableros, paneles, ventanas, persianas, etc. La larga durabilidad, estabilidad del color, estanqueidad al agua y resistencia a la humedad, son las características que hacen del PVC un material idóneo para muebles de baño y de cocina. La limpieza de este material es fácil y rápida y se realiza con agua y jabón, aunque por su resistencia permite el empleo la mayoría de productos de limpieza.



## PLÁSTICO

Cosmic utiliza plásticos técnicos de distintas características en función de las necesidades de fabricación y estéticas de cada producto o pieza. Entre los plásticos utilizados están: ABS (cromado o no), PP, PA, PE, PC, PS, etc.



## CRISTAL ACRÍLICO

El Polimetilmetacrilato (PMMA) es conocido como uno de los "plásticos de la ingeniería", se obtiene de la polimerización del metacrilato de metilo. Destaca frente a otros plásticos por la resistencia a los impactos, a la intemperie, ya que no sufre un envejecimiento apreciable en diez años de exposición exterior y a los rayos UVA, y por la resistencia al rayado. Por su transparencia máxima (es el plástico más transparente), las funciones más habituales van desde los faros de los vehículos, la óptica, la medicina o mamparas separadoras. Para su uso en la arquitectura y decoración se beneficia de un peso menor al del vidrio y mayor resistencia a impactos por lo cual puede ser un buen sustituto en muchas ocasiones.



## ACERO INOXIDABLE

Aleación de hierro con carbono que conserva las propiedades de dureza del hierro. Se trata de un acero con un tratamiento especial de cromo, contra la corrosión y oxidación. Las aleaciones utilizadas son la SS303 y SS304.



## LATÓN O ALEACIONES ANÁLOGAS (cromo brillante y cromo mate)

Aleación de cobre y zinc, es uno de los metales no férricos, cuya proporción varía en función de su aplicación. Destaca su maleabilidad, más alta que la del cobre y zinc por separado, y fácil pulido lo cual permite un alto grado de adaptación en el diseño de las piezas.





### ALUMINIO

Aleación de aluminio. Se puede presentar como macizo extrusionado, estirado y calibrado. El aluminio es un metal importante para una gran cantidad de industrias, como la del automóvil, donde se utiliza habitualmente. Tiende a ser blando y presenta puntos de fusión bajos.



### ACERO VITRIFICADO (VIT-TECH)

Material tecnológicamente avanzado y 100% reciclable que nace de la cocción de una superficie de acero esmaltada previamente. Es un material no poroso, higiénico y resistente a la corrosión, a las altas temperaturas y a agentes químicos debido a la naturaleza vítrea del esmalte. Esta característica le confiere una gran dureza permitiendo una amplia gama de aplicaciones en bañeras, platos de ducha y lavabos así como hornos y revestimientos. Es un material de fácil limpieza que no requiere la utilización de productos de limpieza específicos.



### TECKSTONE

Formulación avanzada compuesta de minerales naturales (carbonato de calcio y cuarzo) mezclados con resina. La película Gelcoat Premium Maxguard™, con fibras de plástico y polímeros, recubre la superficie proporcionando la durabilidad y resistencia que necesita el uso diario intensivo. Se trata de una superficie sólida con excelentes propiedades físico-mecánicas que ofrece grandes posibilidades de diseño. Su capacidad de moldeo permite reproducir formas con gran precisión y con menores radios de curvatura. Teckstone es muy resistente, compacto y de gran dureza. Al ser un material no poroso y carente de juntas, su mantenimiento es muy sencillo, las manchas se eliminan sin esfuerzo y es de fácil limpieza.



### MÁRMOL

**Mármol carrara** (Blanco mate y brillo). Extraído de las canteras de la Toscana italiana, cada pieza de mármol es diferente y cada piedra tiene sus propias características. Con fondo blanco tiene distintivas vetas de color azul grisáceo claro repartidas por toda la superficie.

**Mármol marquina** (negro mate y brillo). Elegante y clásico, cada pieza de mármol es diferente y cada piedra tiene sus propias características. Se extrae de las canteras en Marquina (Vizcaya) y se caracteriza por sus vetas de color blanco sobre la piedra negra. Cuantas menos vetas, más apreciado.

**Mármol brescia** (marrón mate y brillo). Extraído de las canteras de la región de Lombardía (Italia). Considerado uno de los mármoles italianos más suntuosos.



### PORCELANA

Producto cerámico que se obtiene a partir de una pasta muy elaborada compuesta por caolín, feldespato y cuarzo. La porcelana es tratada con un acabado final vitrificado que da a la superficie la dureza superficial, color, brillo, no porosidad e higiene idóneos para su uso en el baño. Este vitrificado permite limpiarla con cualquier producto destinado a la limpieza del baño.



### CERÁMICA

El lavabo está hecho de forma tradicional, se caracteriza por una alta durabilidad, resistencia a la abrasión y agentes químicos.



### FÉNIX®

Material suave al tacto de elevadas prestaciones: reparabilidad térmica de micro-arañazos, anti-huella digital, resistencia a los arañazos, alta resistencia a los disolventes y reflectancia mínima a la luz. Los productos de FENIX® están realizados de papel (más del 60 %) y de resinas termoendurecedoras (30-40 %). Están creados por un proceso de presión en el que el calor y la presión se aplican de manera simultánea para obtener un producto homogéneo no poroso. La estructura del núcleo está compuesta de papel, impregnado con resinas termoendurecedoras. La superficie exterior está tratada con resinas acrílicas de nueva generación, endurecidas y fijadas con el proceso Electron Beam Curing. No requiere ningún mantenimiento especial, solo un paño húmedo con agua templada o detergentes suaves. Para las manchas más comunes es suficiente con limpiar la superficie con agua templada usando un paño no abrasivo. Si los residuos son antiguos o se han endurecido, usar una esponja mágica o un paño suave para eliminarlos. Siempre enjuagar a fondo para eliminar el detergente con agua limpia, preferiblemente tibia. Las pruebas han demostrado que la eliminación de micro arañazos superficiales mediante "esponja mágica" tiene lugar tanto inmediatamente como después de 24 horas.



### SOLIDMAT

Un solid surface con un alto porcentaje de cargas minerales naturales. Destaca por su tacto satinado y su durabilidad. Es un material ignífugo, compacto y no poroso, higiénico y resistente. Disponible en blanco mate homogéneo.

## INSTRUCCIONES DE LIMPIEZA

Las superficies pueden limpiarse con productos de limpieza líquidos o con agua jabonosa. (Tener en cuenta las instrucciones de uso del fabricante de detergentes). A continuación aclarar con abundante agua y pulir con una gamuza. No utilizar productos de limpieza que contengan ácidos, vinagre o que sean abrasivos. No nos responsabilizaremos si los desperfectos se producen a causa de un manejo inadecuado.



# Sales conditions

## EXPORT GENERAL SALES CONDITIONS

- 1**

The sales of INDUSTRIAS COSMIC S.A.U. are ruled by the herewith detailed general sales condition and the delivery of any order implies the buyer's acceptance of these general conditions.
- 2**

The products can be modified, replaced or cancelled at any time and all information of any kind included in our catalogues, price lists or advertising materials are indicative.
- 3**

Orders received from customers or through our salesmen are always subject to our previous approval and are considered confirmed unless otherwise specified.
- 4**

No order accepted by INDUSTRIAS COSMIC, S.A.U. can be amended or cancelled without our approval. The customer, as far as he is concerned, cannot return any goods to us without our previous acceptance or consent.
- 5**

Goods will be invoiced in accordance with our current price list at the moment of shipment. The prices are F.C.A. Barcelona for orders above € 1,500; for orders below € 1,500 goods will be shipped under Ex-Works conditions.
- 6**

Unless otherwise agreed, the payment terms are:  
-Irrevocable Letter of Credit at sight  
-Advanced Bank Transfer  
-Cash Against Documents
- 7**

INDUSTRIAS COSMIC, S.A.U. offers 3 years guarantee, in exception of the indicated in the price list, against raw material and manufacturing defects. The guarantee is valid from the time of purchase by the final customer. To confirm the date of purchase, the invoice of the consumer should be provided. The guarantee consists of the replacement of the defective piece that impedes the regular use of the item, except in case of improper use, incorrect assembly or installation, natural wear and tear, improper maintenance or, chemical, electrochemical or electrical influences. We are not responsible for all the damage brought about by misuse or bad installation of the products and won't accept any indemnities for the replacement of defective pieces or any demands for damage.
- 8**

INDUSTRIAS COSMIC, S.A.U. always try to minimize the customer service time and to meet the lead time requirements on our customers' orders as much as possible. In case we cannot satisfy them, customers will be duly advised.
- 9**

Ordered COSMIC products will be delivered under reservation of title in favour of INDUSTRIAS COSMIC, S.A.U. until all payment obligations by the purchaser have been met in full.
- 10**

In case of outstanding payments, the return and bank expenses are on the purchaser's. INDUSTRIAS COSMIC S.A.U. has the right to block all orders accepted as long as the outstanding payments are not sorted out.
- 11**

In case of claims regarding the interpretation or execution of the herewith sales conditions, will be competent the courts of our head office's jurisdiction.
- 12**

COSMIC provides information on the certifications with which we comply as a manufacturer. It is the responsibility of the fitter to know the local certifications required in the relevant country.

## **B** CONSULT SPECIAL CONDITIONS



# Condiciones de venta

## CONDICIONES GENERALES DE VENTA EXPORTACIÓN

- 1**  
Las ventas de INDUSTRIAS COSMIC, S.A.U. se realizan según las condiciones generales aquí expuestas y la entrega de cualquier pedido supone la aceptación, por parte del comprador, de dichas condiciones generales de venta.
- 2**  
Los productos se pueden modificar, reemplazar o suprimir en todo momento y la información de cualquier naturaleza contenida en nuestros catálogos, tarifas o material publicitario es indicativa.
- 3**  
Los pedidos recibidos directamente de los clientes o realizados por nuestros representantes en nombre de ellos siempre estarán sujetos a nuestra aceptación. INDUSTRIAS COSMIC, S.A.U. da por confirmados todos los pedidos recibidos y, si no hay notificación específica se entenderán como aceptados.
- 4**  
Ningún pedido aceptado por nosotros se podrá retractar ni anular sin nuestra aceptación. El cliente, por su parte, no podrá efectuar ninguna devolución de mercancía sin nuestro consentimiento previo.
- 5**  
La mercancía será facturada de acuerdo con nuestra tarifa vigente en el momento del envío. Los precios serán F.C.A. Barcelona para pedidos superiores a 1.500€. Los pedidos inferiores a 1.500€ serán enviados ExWorks.
- 6**  
De no existir otro acuerdo, las condiciones de pago serán:  
-Letra de crédito irrevocable a la vista  
-Transferencia por avanzado  
-Contado contra documento
- 7**  
INDUSTRIAS COSMIC, S.A.U. ofrece una garantía de 3 años, excepto en los casos indicados en la tarifa, contra todos los defectos de materia prima y fabricación válida a partir del momento de adquisición por parte del cliente final. A fin de determinar la fecha de adquisición será imprescindible la presentación de la factura de compra. Esta garantía consistirá en la sustitución de la pieza que determine su irregular funcionamiento, salvo por razones de uso inadecuado, montaje o instalación incorrectos, mantenimiento indebido, desgaste del uso diario o defectos provocados por reacciones químicas, electroquímicas o eléctricas. La garantía excluye de responsabilidad a INDUSTRIAS COSMIC, S.A.U. de todas las consecuencias derivadas del funcionamiento o instalación de nuestros productos y esta no reconoce ninguna indemnización por la sustitución de artículos defectuosos ni demanda por daños y perjuicios.
- 8**  
INDUSTRIAS COSMIC, S.A.U. intenta siempre reducir al máximo los tiempos de servicio al cliente, ajustándose en lo posible a los requisitos de plazo solicitados expresamente en el pedido y, en caso de no poder satisfacerlos, se enviará una notificación.
- 9**  
Los productos marca COSMIC, objeto de pedido, se entregarán bajo reserva de dominio a favor de INDUSTRIAS COSMIC, S.A.U. hasta el total cumplimiento de las obligaciones de pago por parte del comprador.
- 10**  
En caso de impagados, se incurre en un cargo por devolución, más los gastos de financiación actuales en el mercado. INDUSTRIAS COSMIC, S.A.U. se reserva el derecho de retener los pedidos en curso hasta solucionar los efectos pendientes.
- 11**  
Las disputas referentes a la interpretación o a la ejecución de estas condiciones generales de venta pasarán a ser competencia de los tribunales de nuestra jurisdicción.
- 12**  
COSMIC aporta la Información de las certificaciones que cumplimos como fabricantes. Es responsabilidad de los instaladores conocer las certificaciones necesarias en cada país.



**B** CONSULTAR CONDICIONES ESPECIALES



INDUSTRIAS COSMIC  
C/ESQUEIS S/N. LOCAL 1  
POL. IND. CAN BARRI  
08415 BIGUES I RIELLS  
BARCELONA SPAIN  
T. +34 938 654 277  
info@icosmic.com  
**www.icosmic.com**

PRINTING DATE: DECEMBER 2023  
FECHA DE IMPRESIÓN: DICIEMBRE 2023







**ART DIRECTION**  
COSMIC STUDIO

**GRAPHIC DESIGN**  
AT COMUNICACIÓ

# COSMIC

**INDUSTRIAS COSMIC, S.A.U.**

C/ESQUEIS S/N LOCAL 1  
POL. IND. CAN BARRI  
08415 BIGUES I RIELLS BARCELONA SPAIN

**CENTRAL OFFICE** TEL +34 938 654 277

**INTERNATIONAL PHONE** TEL +34 938 664 101

**SHOWROOM** C/ESQUEIS S/N LOCAL 1 POL. IND. CAN BARRI  
08415 BIGUES I RIELLS BARCELONA SPAIN

info@icosmic.com  
cosmicbrand.com



cosmicbrand

